

Gammakatsu

CATALOG 2027

NEW PRODUCTS 2027 ...



Precision Optics for Serious Anglers

On the water, clarity is performance. The new GSPECX™ line from Gamakatsu gives anglers a decisive visual edge—because what you see determines how you fish.

Precision Optics. Total Focus.

Unmatched clarity. Near-zero distortion. Less eye fatigue – so you stay sharp all day, from first light to midday glare.

- Crystal-clear, distortion-free optics
- Reduced eye strain for longer performance
- Advanced glare reduction with full UV protection

Spot What Others Miss Beneath the Surface

GSPECX enhances your ability to read water and revealing structures, weed lines, and fish with precision, giving an added advantage for a strike.

Built with input from best sight fisherman in the world, these are tools – not accessories.



GSPECX – Technology

POLARIZED LENSES BY TALEX

TALEX lenses are crafted in Japan through a unique collaboration between skilled artisans and optical scientists. By combining advanced technology with generations of refined craftsmanship, each lens delivers exceptional clarity—reducing eye strain while enhancing all-day visual comfort.

Over 99% UV Protection

All lenses are rated UV400, blocking more than 99% of harmful UVA and UVB rays. While many lenses only filter up to 380 nm, these go further—shielding your eyes from the most penetrating UV radiation for complete protection.

Proprietary Polarization Technology

How Polarization Works



Advanced polarized filters block harsh horizontal light, eliminating glare from reflective surfaces like water and pavement. Built with proprietary iodine-based compounds, these lenses outperform traditional polarization for sharper, more precise vision in bright conditions.

An exclusive Light Purifying Filter removes UV rays, glare, and intrusive light, helping your eyes stay relaxed and focused. By minimizing fatigue and strain, it supports long-term eye health—even during extended wear.

GSPECX - GENKAI



Inspired by the fast-moving waters of Japan's Genkai region, this line of sunglasses is built for clarity, control, and all-day performance. Polarized lenses cut glare, enhance contrast, and provide full UV protection, while the lightweight wrap frame delivers a secure, comfortable fit that stays locked in through every cast. Designed for anglers who value precision and clean, modern style, Genkai brings focus to every moment on the water.

Available in regular and wide. Page 166

GSPECX - BIWA



Inspired by the depth and clarity of Japan's legendary Lake Biwa, this line of sunglasses is designed for steady vision in changing conditions. Premium polarized lenses filter glare while maintaining natural color and reducing eye fatigue, and the ergonomic wrap frame offers a secure, comfortable fit for long days outdoors. Built for anglers who rely on consistency and control, Biwa delivers dependable clarity from first light to last cast.

Available in regular and wide. Page 167



Genkai Green



Genkai Copper



Genkai Brown



Biwa Green



Biwa Copper



Biwa Brown



Genkai Dark
Gray Mirror



Genkai Light
Gray Mirror



Genkai Yellow
Mirror



Biwa Dark
Gray Mirror



Biwa Light
Gray Mirror



Biwa Yellow
Mirror

GSPECX COLORS FOR DIFFERENT CONDITIONS

Green: Ideal for low-light conditions, such as early morning, late evening and cloudy days, helping you to easily spot changes underneath the surface.

Copper: Excellent for sight fishing in variable light, enhancing contrast to better spot fish against changing backgrounds.

Brown: A versatile choice for inshore and freshwater fishing, improving clarity and depth perception throughout the day.

Dark Gray Mirror: Best for harsh sun and offshore fishing, cutting intense glare while maintaining accurate color for long days on the water.

Light Gray Mirror: Great for bright, open water days when you need true color and reduced glare without overly darkening your view of the surface.

Yellow Mirror: Keeps your field of vision bright while reducing glare from the water's surface, enhancing the visibility of white objects.

2027 NEW PRODUCTS

Outsider Treble

Designed in conjunction with two time Bassmaster AOY Chris Johnston, the Outsider Treble is engineered for anglers demanding maximum penetration and corrosion resistance in high pressure environments. Featuring **NANO ALPHA** Technology for 2x better hook penetration and 4x better corrosion resistance, this new treble hook also incorporates an outward angled point to improve hookup ratios. A large barb enhances holding power, keeping fish pinned during aggressive fights. The Nano Alpha coating further reduces friction for faster, more efficient penetration. *Available Sizes: 6, 5, 4, 3, 2, 1, 1/0. Page 29*



Treble Round Bend (Fluorescent Series)

Designed to add both visibility and attraction, the Treble Round Bend Fluorescent Series offers a vibrant edge for species that key in on color. Ideal for panfish, ice fishing, and kokanee applications, these trebles provide reliable round bend performance paired with high visibility finishes that enhance lure presentation in varying water conditions.

Available Sizes: 12, 10, 8, 6, 4

Available Colors: Fluorescent Pink, Fluorescent Orange, Chartreuse. Page 35



Treble S-SP XH

Engineered for maximum penetration and holding power, the Gamakatsu Treble S-SP XH **NANO ALPHA** is built to handle aggressive predators. Featuring an extra-heavy construction, larger barb, and short shank design, it delivers secure hooksets while reducing leverage that can lead to lost fish. Gamakatsu's slick Nano Alpha coating reduces friction for faster penetration, making it an excellent choice for upgrading plugs, casting baits, jigs, and spoons targeting hard-fighting species. *Available Sizes: 1/0, 2/0, 3/0, 4/0, 6/0. Page 33*



Treble S-SP XH

Built for anglers targeting powerful saltwater gamefish, the Gamakatsu Treble S-SP XH **HYPERSHIELD** delivers the strength and reliability needed for demanding inshore and offshore applications. Its extra-heavy construction and short shank design help reduce leverage during the fight, minimizing pulled hooks when trophy fish surge boatside. Finished with Gamakatsu's corrosion-resistant Hyper Shield coating, this premium treble is ideal for upgrading factory hooks on plugs, spoons, and jigs fished in harsh saltwater environments.. *Available Sizes: 1/0, 2/0, 3/0, 4/0, 6/0. Page 34.*



Single Hook 52

The Single Hook 52 features an oversized eye engineered to fit split rings when replacing existing treble or single hooks. Ideal as a replacement hook for smaller spoons, the enlarged eye allows greater movement on the split ring, reducing leverage and minimizing lost fish during the fight.

Available Sizes: 12, 10, 8, 6, 4, 2, 1, 1/0, 2/0. Page 55



Single Hook 53

Designed specifically for smaller plug applications, the Single Hook 53 incorporates a large inline eye that fits over split rings while maintaining proper lure alignment. The inline eye design reduces snags and improves hookup efficiency, offering a refined alternative to traditional treble setups. *Available Sizes: 12, 10, 8, 6, 4, 2, 1. Page 55*



Ball Rig Hook

Purpose-built for today's popular urchin-style finesse baits, the Gamakatsu Ball Rig Hook delivers the ideal balance of natural presentation and reliable hook-up performance. Its wide gap design perfectly accommodates bulky soft plastics, while Tournament Grade Wire (TGW) construction and **NANO ALPHA** technology provide exceptional sharpness, strength, smoother penetration, and corrosion resistance. An innovative Weight Clip system allows anglers to quickly adjust weight sizes without retying, making it easy to fine-tune presentation and fall rate for changing conditions. *Available Sizes: 1, 1/0, 2/0, 3/0, 4/0, 5/0. Page 56*



Ball Rig Hook Weedless

Built for fishing urchin-style finesse baits in heavy cover, the Gamakatsu Ball Rig Hook Weedless combines a wide gap design with a premium titanium weedguard for excellent snag resistance without sacrificing hook-up performance. Constructed from Tournament Grade Wire (TGW) and enhanced with **NANO ALPHA** technology, it delivers superior sharpness, strength, smooth penetration, and corrosion resistance. The integrated Weight Clip system allows for fast weight adjustments, giving anglers precise control over bait action and presentation. *Available Sizes: 1, 1/0, 2/0, 3/0, 4/0, 5/0. Page 56*



Single Hook 53 Salt

Purpose built for saltwater plug applications, the Single Hook 53 Salt incorporates a large inline eye designed to fit seamlessly onto split rings. The Magic Eye ensures easy attachment and removal, while Hyper Shield coating increases corrosion resistance and maintains sharp hook points longer. The inline configuration helps maintain proper lure tracking and consistent hookups in harsh saltwater conditions. *Available Sizes: 8, 6, 4, 2, 1, 1/0, 2/0. Page 116*



Worm 34R Hydroll

Designed for precise, natural presentations, the Gamakatsu Worm 34R Hydroll delivers refined performance for finesse and soft plastic applications. Its unique hydrodynamic bend and extended shank promote smoother bait movement and improved tracking, while the integrated swivel reduces line twist for consistent action cast after cast. Built with Gamakatsu's signature sharpness and strength, the 34R Hydroll is a dependable choice when subtlety and control make all the difference. *Available Sizes: 7/0, 8/0, 9/0, 10/0, 11/0. New Size Additions: 1/0, 2/0, 3/0. Page 67*



Bead Hook

The Bead Hook is purpose-built for bead fishing salmon and steelhead. Made with Gamakatsu's Tournament Grade Wire (TGW), it's thinner, stronger, and sharper for easy penetration through hard jaw plates. **NANO ALPHA** technology delivers superior corrosion resistance and a slick finish for improved hooksets. The longer shank, wider gap, and needlepoint design help anglers land more big, hard-fighting fish. *Available Sizes: 6, 4, 2, 1, 1/0, 2/0, 3/0. New Size Additions: 4/0, 5/0. Page 41*



Pluggin' Single HD- Ringed

Built for strength and durability, the Pluggin' Single HD-Ringed hook features a solid one-piece ring that promotes natural lure movement while maintaining heavy duty integrity. Designed as a bait hook for both large freshwater and saltwater species, it excels in chunk bait applications targeting bottom fish such as grouper, halibut, and other powerful saltwater species. The tin finish enhances corrosion resistance in demanding environments. *Available Sizes: 7/0, 8/0, 9/0, 10/0, 11/0. Page 118*



G-Box Quatro Joint Loc Case 250

The Quatro Joint Loc Case 250 features a Joint Loc system that securely connects two locking boxes into one cohesive unit for streamlined storage. A micro rib adjustable divider system keeps terminal tackle separated and secure, making it perfect for day use, backpacking anglers, or fishermen on the go. *Size: 6.9 x 4.1 x 0.7 in. Page 154*



Pluggin' Single HD-Assist

The Pluggin' Single HD-Assist delivers heavy duty performance for large lure applications where strength and reliability are critical. Designed for demanding freshwater and saltwater species, this model offers anglers a durable single hook alternative when upgrading or replacing factory hardware. *Available Sizes: 7/0, 8/0, 9/0, 10/0, 11/0. Page 126.*



2027 NEW PRODUCTS

G-Box Tuning & Terminal Utility Case

Designed for organization and efficiency, the Tuning & Terminal Utility Case features a clear lid for quick visibility, and a one hand latch system for easy access on the water. Multiple adjustable dividers allow anglers to customize the interior layout to fit hooks, weights, terminal tackle, and tuning accessories, keeping essential gear secure and organized.

Size: 10 x 7.5 x 1 in. Page 154



Trucker Hat Mesh

Built for everyday wear on and off the water, the Gamakatsu Trucker Hat delivers classic style with breathable comfort. Featuring a structured mid-profile, pro-model crown and trucker mesh back, it keeps you cool while maintaining a clean, modern fit. Contrast stitching and a slightly curved visor add a timeless snapback look, while the durable poly/cotton blend ensures long-lasting wear. Finished in Khaki/Brown, it's a go-to lid for anglers who want performance and style in one. Page 181



G-Box Adjustable Lure Case 3200

The Adjustable Lure Case 3200 incorporates dividers that lock in place with foam backing to hold lures securely during transport. A center divider keeps both sides separated to prevent tangling, making it ideal for storing spoons, spinners, flies, and ice jigs. Designed for versatility and protection, this case offers efficient storage for a wide range of lure styles.

Size: 8.1 x 5.7 x 0.9 in Page 154



LUXXE T-Shirt

Clean, classic, and built for everyday comfort, the LUXXE T-Shirt delivers a premium look that reflects the heritage of advanced rod design. Featuring the bold LUXXE logo across the chest with subtle sleeve detailing, this tee combines soft, breathable fabric with a modern fit that wears easy on and off the water. Whether you're on the boat or off the clock, it's a straightforward staple for anglers who appreciate performance-driven style. Sizes: S-3L. Page 183



Sunshield

Built for all-day protection and comfort, the Gamakatsu Sun Shield is a versatile performance neck gaiter designed to keep you covered on and off the water. Made from 100% polyester microfiber, its seamless construction delivers a smooth, irritation-free fit, while the lightweight, breathable fabric features speed-dry performance to keep you cool in hot conditions. Ideal for sun, wind, and dust protection, it can be worn multiple ways for maximum utility. Available in Blue Camo and Gray Camo. 20" L x 9 1/8" W One size fits most. Page 181



LUXXE Long Sleeve T-Shirt

Built for comfort with a bold, performance-driven look, the LUXXE Long Sleeve T-Shirt delivers everyday wearability on and off the water. Featuring the signature LUXXE logo across the chest and down the sleeves, this shirt combines soft, breathable fabric with added coverage for changing conditions. Designed with a modern fit and durable construction, it's a versatile staple for anglers who want clean style with all-day comfort. Sizes: S-3L. Page 183



HISTORY OF GAMAKATSU

Invention of hooks

20,000 years ago, the invention of the fish hook marked the beginning of sport fishing. The first hooks were made of wood or bones. As technology improved, so did the hooks. Records show that copper hooks were made in Banchen 7,000 years ago and artificial flies were used in Egypt 4,000 years ago. Fishing was also a popular form of entertainment in ancient China.

Today, modern materials and manufacturing techniques have resulted in hundreds of styles of extremely high quality hooks, designed for specific types of fish and fishing methods.

Quality of hooks

Gamakatsu hooks are the corner stone of the Gamakatsu company, and are famous worldwide. Material and technology are what makes these hooks superior to all other brands. The Gamakatsu company, in conjunction with a material manufacturer, developed a material known as High Carbon steel specifically for the manufacture of fish hooks. This material not only contains a higher percentage of carbon, but also has very few impurities. As a result, GAMAKATSU has earned Anglers' trust throughout the world. The life of a fish hook is measured by the sharpness, hardness, and viscosity of the point. Using low quality materials results in points that are weak and not truly sharp. In order to use High Carbon steel, Gamakatsu developed a unique electronic tempering process which enables hooks to be tempered in a stable condition. As a result, Gamakatsu is able to manufacture consistently high quality, extremely sharp hooks in large quantities.

Hook producing

The methods used in creating Gamakatsu hooks is what makes it so superior to all other brands. First, only the most premium grade of high carbon steel is used. This insures against any blemishes in the metal which can weaken the hook.

Secondly, Gamakatsu has the most advanced tempering system in the world. Every hook is heated to the exact temperature that is perfect for that particular style and size then cooled in oil. This process produces hooks which are super strong, but not brittle. It is extremely difficult to achieve a balance between strength and flexibility, and it took many years for Gamakatsu to perfect this process.

Finally, and perhaps most importantly, our sharpening process is the most modern in the world, and results in a perfectly conical point that is unequalled in sharpness.

Gamakatsu started producing fish hooks in 1955. At that time, they were the smallest hook manufacturer in Japan and all of their hooks were made by hand. In 1963 they introduced a new automated heating facility which catapulted them to the forefront of the Japanese market. In 1974, they introduced fully automated hook making machines and found it necessary to build a second factory in order to meet the demand they had created.

In 1976, being well established as the leading Japanese hook manufacturer, Gamakatsu started building a new factory to produce high quality fishing rods for the Japanese market.

After upgrading the hook manufacturing machines in 1986, they expanded their product line. As a result, Gamakatsu Co. Ltd became a major manufacturer with a full line of high quality fishing rods, hooks, apparel, and fishing related items by 1987.

In 1988, after upgrading the automated tempering facilities and expanding the hook factory, Gamakatsu Co. Ltd opened Gamakatsu International Co., Ltd. in Thailand and Gamakatsu Shantou Co. Ltd. in China in 1989.

When anglers purchase Gamakatsu hooks, they are buying an original product made by GAMAKATSU. Many hook suppliers are using fabricated Japanese sounding names bought from several different manufacturers.

Market Leader GAMAKATSU

Gamakatsu is the leading fish hook manufacturer in Japan. They are constantly testing new materials, trying to improve their product which already sets the standard for the rest of the industry.

In 1992 Gamakatsu USA Inc. was established to provide Gamakatsu brand hooks to the U.S. market. Obviously, Gamakatsu is well on it's way of achieving their goal of becoming the market leader in the USA and the world!

Environment has our attention

Since 1955, Gamakatsu has strictly stuck to the theme of "Nature and Technology". We work hard to develop new, hi-tech products that benefit the outdoorsman without adversely effecting the environment.

SIMPLY THE BEST

Gamakatsu's dedication to producing the highest quality fish hook made, as well as the innovation they bring to the industry has kept the company at the forefront of the premium hook market. Among the innovative ideas that Gamakatsu has introduced are:

- **Durability** - A unique tempering process allowing us to make a hook of superior strength and durability.
- **Strength** - Hooks made of high carbon steel for superior strength.
- **Sharpness** - Conically needle honed points that are sharp from the package and stay sharp.
- **Color Variation** - Colored hooks in red, blue, green, gold, nickel, Bronze, black, shrimp and fluorescent colors F-red, F-chartreuse, F-pink, F-orange, F-glow, F-green, F-purple to match the color of your lure or bait.
- **Style Variation** - Innovative hook designs like the extra wide gap (EWG) that hook and hold fish better.



ALL OVER THE WORLD

Gamakatsu products are used worldwide. With offices located around the world, Gamakatsu is able to research its markets and develop unique products that meet the needs of even the most demanding anglers.

Gamakatsu's policy of technical development has always been "the best of quality". We are always searching for new ways to make our existing products better in addition to constantly looking for unique products which are not yet available. We believe that only this attitude can give our customers the best they deserve!

DISTRIBUTED BY:

Western United States

Gamakatsu[®]

P.O. Box 1797 • Tacoma, WA 98401
7218 45th St. Ct. E., Suite 100, Fife, WA 98424
253-922-8373 • Fax 800-223-9383

Eastern United States

SPRO

3750 Kennesaw 75 Pkwy, Suite 100
Kennesaw GA 30144
770-919-1722 • Fax 770-919-8141

COLORS AND CHARACTERISTICS ...



NICKEL

BRONZE

NS BLACK

RED

GREEN

BLUE

F-RED

CHARTREUSE

F-PINK

F-ORANGE

GLOW

F-GREEN

F-PURPLE

ULTRA VIOLET



EYE



OPEN EYE



BARB

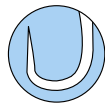

BARBLESS



OUT-BARB



EWG - EXTRA WIDE GAP



WELDED EYE



MAGIC EYE

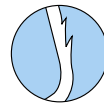

BARB(S) ON SHANK

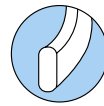

FORGED

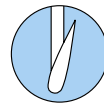

OFF-SET POINT



CIRCLE HOOK



TIN KEEPER

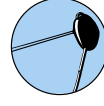

TITANIUM WEEDGUARD

NANO SMOOTH COAT



SuperLine



NO BARB



Tournament Grade Wire



NANO ALPHA







G-FINESSE, pages 17-26

G-POWER, page 27-29

TREBLE HOOKS, pages 30-37

ALL PURPOSE HOOKS, pages 38-51

FRESHWATER HOOKS, pages 52-62

WORM HOOKS, pages 63-77

JDM, pages 78-81

JIG HOOKS, pages 82-87

JIG HEADS, pages 88-98

LURES, pages 99-100

BAITS, pages 101-105

WEIGHTS, pages 106-108

SALTWATER, pages 109-120

ASSIST HOOKS, pages 121-129

RIGS AND SNELLS, pages 130-138

FLY HOOKS, pages 139-147

TERMINAL, pages 148-152

TACKLE STORAGE, pages 153-163

GSPECX PRECISION OPTICS, pages 164-167

TOOLS AND ACCESSORIES, 168-172

FLOATS, pages 173-174

KNIVES, pages 175-178

APPAREL AND GEAR, pages 179-183

DECALS, page 184

TABLE OF CONTENTS

| G-Finesse by Aaron Martens | Page |
|--|-------------|
| G-Finesse Drop Shot | 21 |
| G-Finesse Heavy Cover Worm | 21 |
| G-Finesse Treble Short Shank Treble | 21 |
| G-Finesse Short Shank Treble MH | 21 |
| G-Finesse Feathered Treble MH | 22 |
| G-Finesse by Shin Fukae | |
| G-Finesse Swivel Shot Octopus | 22 |
| G-Finesse Swivel Shot Drop Shot | 22 |
| G-Finesse Swivel Shot Worm | 23 |
| G-Finesse Weedless Wacky | 23 |
| G-Finesse Jig Head Wacky | 23 |
| G-Finesse Tricky Head | 23 |
| G-Finesse Cover Neko | 24 |
| G-Finesse Worm Light Wire | 24 |
| G-Finesse Tournament Snap | 24 |
| G-Finesse by Mike McClelland | |
| G-Finesse Hybrid Worm | 25 |
| G-Finesse by Brent Ehrler | |
| G-Finesse Stinger | 26 |
| G-Finesse Weedless Stinger | 26 |
| G-Finesse Stinger Drop Shot | 26 |
| G-Power | |
| G-Power Heavy Cover Flip and Punch | 28 |
| G-Power Stinger Trailer | 28 |
| G-Power Outsider Treble NEW | 29 |
| Treble Double Hooks | |
| Treble SP Medium Heavy Hypershield | 32 |
| Treble SP XH | 32 |
| Treble S-SP XH • NANO ALPHA • NEW | 33 |
| Treble S-SP XH • HYPERSHIELD • NEW | 34 |
| Treble Round Bend • NEW COLORS | 35 |
| Treble Round Bend Barbless | 35 |
| Treble 2x Strong Round Bend | 35 |
| Treble Short Shank, (Magic Eye), Round Bend | 35 |
| Treble Big Bait Special Round Bend | 36 |
| Treble Extra Wide Gap (EWG) | 36 |
| Treble EWG Short Shank (Magic Eye) | 36 |
| Treble EWG Short Shank 2x Strong (Magic Eye) | 36 |
| Treble 4x Strong | 37 |
| Feathered Treble | 37 |
| Double 22 Medium Shank | 37 |
| EWG Double | 37 |
| All Purpose | |
| Octopus • NANO ALPHA | 40 |
| Walleye and Steelhead Assortment | 41 |
| Fluorescent Walleye and Steelhead Assortment | 41 |
| Bead Hook • NEW SIZES | 41 |
| TGW Octopus | 41 |
| Octopus Light | 42 |
| Octopus Barbless | 42 |

| All Purpose, continued | Page |
|--|-------------|
| Octopus Straight Eye | 42 |
| Octopus Straight Eye, 4x Strong • NANO ALPHA | 43 |
| Octopus Straight Eye, 4x Strong (Inline-Point) | 43 |
| Octopus Circle (Offset-Point) • NANO ALPHA | 44 |
| Octopus Circle (Inline-Point) | 44 |
| Octopus Circle Barbless (Inline-Point) | 44 |
| Octopus Circle Outbarb 1x Strong | 45 |
| Octopus Circle Straight Eye (Inline-Point) • NANO ALPHA | 46 |
| Octopus Circle Straight Eye 4x Strong (Offset-Point) • NANO ALPHA | 46 |
| Octopus Circle Straight Eye 4x Strong (Inline-Point) • NANO ALPHA | 47 |
| Crankbait Circle (Bill Dance) | 47 |
| Big River Bait | 48 |
| Big River Bait Barbless | 49 |
| Big River Bait Open Eye | 49 |
| Baitholder Hooks | 50 |
| Siwash Open Eye | 51 |
| Fresh Water Hooks | |
| Spin Bait | 54 |
| TW Hook | 54 |
| Single Egg Hook | 54 |
| Aberdeen | 54 |
| Crappie Assortment | 54 |
| Single Hook 52 • NEW | 55 |
| Single Hook 53 • NEW | 55 |
| Walleye Wide Gap | 55 |
| Shiner Straight Eye | 55 |
| Shiner Upturned Eye | 56 |
| Ball Rig Hook • NEW | 56 |
| Ball Rig Hook Weedless • NEW | 56 |
| Wicked Wacky | 57 |
| Antenna Hook | 57 |
| Split Shot/Drop Shot | 58 |
| Split Shot/Drop Shot Weedless | 58 |
| Super Tuned Drop Shot | 58 |
| Finesse Wide Gap | 59 |
| Finesse Wide Gap Weedless | 59 |
| G-Stinger | 59 |
| Trout Stinger | 59 |
| Stilto - Mr. Crappie, Wally Marshall | 60 |
| Sticker - Mr. Crappie, Wally Marshall | 60 |
| Trailer Hook SP | 60 |
| Spinner Bait Trailer | 60 |
| Spinner Bait | 60 |
| Ice Fishing | |
| Micro V Gap | 61 |
| Micro Perfect Gap | 61 |
| Micro Wide Gap | 61 |
| G-Carp | |
| G-Carp Super Hook | 61 |
| G-Carp Specialist RX | 61 |
| G-Carp Specialist R | 61 |
| G-Carp Hump Back | 61 |
| Catfish | |
| Catfish Circle Weedless | 62 |
| Big Cat Circle | 62 |
| Catfish Assortment | 62 |

| Worm Hooks | Page |
|--|-------------|
| Worm, Extra Wide Gap (EWG) • NANO ALPHA | 64 |
| Worm, Superline Extra Wide Gap (EWG) • NANO ALPHA | 64 |
| Worm, Superline EWG with Ring | 65 |
| Worm Superline EWG, Weighted | 65 |
| EWG Worm Assortment | 65 |
| Extra Wide Gap (EWG) Monster | 66 |
| Extra Wide Gap (EWG) Monster, Weighted | 66 |
| Worm G-Lock | 67 |
| Worm 34R • NANO ALPHA | 67 |
| Worm 34R Hydroll • NEW SIZES | 67 |
| Worm, Deep Throat Wide Gap | 68 |
| Worm, Offset Shank, O'Shaughnessy Bend • NANO ALPHA | 68 |
| Worm, Offset Shank, Round Bend • NANO ALPHA | 69 |
| Worm Superline Offset Round Bend | 69 |
| Worm, Skip Gap | 69 |
| Worm, Straight Shank, O'Shaughnessy Bend | 70 |
| Worm, Straight Shank, Wire Guard | 70 |
| Worm, Straight Shank, Light Wire | 70 |
| Worm, Straight Shank, Round Bend | 71 |
| Finesse Heavy Cover Worm | 71 |
| Heavy Cover Worm | 71 |
| Super Heavy Cover Worm | 71 |
| Gika Rig | 72 |
| Gika Rig Weight | 72 |
| Superline Spring Lock | 73 |
| Superline Spring Lock, Weighted | 73 |
| Superline Spring Lock Monster, Weighted | 74 |
| Power Drop with Superline EWG | 75 |
| Power Drop with Hybrid Worm | 76 |
| Power Drop with Superline Round Bend | 77 |
| JDM | Page |
| King Cobra Jig • NANO ALPHA | 80 |
| Swimming Shot Neo Swim Jig • NANO ALPHA | 81 |
| Jig Hooks | Page |
| Jig 30 Extra Wide Gap (EWG) | 84 |
| Jig 60° Round Bend | 84 |
| Jig 60° Flat Eye, Light Wire, Round Bend | 84 |
| Jig 60° Flat Eye, Round Bend | 85 |
| Jig 60° Extra Wide Gap (EWG) | 85 |
| Jig 90° Round Bend | 85 |
| Jig 90° Heavy Wire Round Bend • NANO ALPHA | 86 |
| Jig 90° Salty HD | 86 |
| Jig 90° Big River | 87 |
| Jig 90 Big River HD | 87 |
| Jig Heads | Page |
| Spring Lock Spinner | 90 |
| Under Spin Head Mini | 91 |
| Under Spin Head | 91 |
| Superline Swim Bait Head | 92 |
| Stand Up Alien Head | 92 |
| Horizon Head • NANO ALPHA | 92 |
| Horizon Head SN • NANO ALPHA | 93 |
| Horizon Head LG • NANO ALPHA | 93 |
| Horizon Head LG Weedless | 94 |
| Horizon Head LG Weedless Light • NANO ALPHA | 94 |

| Jig Heads, continued | Page |
|---|-------------|
| Finesse Jig Head | 95 |
| Finesse Jig Head EWG | 95 |
| Bottom Knocker Offset | 95 |
| Crappie Jig Head | 96 |
| Round 26 | 96 |
| Round 26R Weedless | 96 |
| Round 211 | 97 |
| Football 24 | 97 |
| Darter 26 | 97 |
| Tube Head | 97 |
| MaxEye Jig Pill Head | 98 |
| MaxEye Jig Swim Head | 98 |
| Lures | Page |
| Spiral Z | 100 |
| Baits | Page |
| DuraScent Shrimp | 103 |
| DuraScent Crab | 103 |
| DuraScent Sandworm | 103 |
| DuraScent Octopus | 104 |
| DuraScent Salmon Eggs | 105 |
| Weights | Page |
| G-Shield Tungsten Worm Weight | 108 |
| G-Shield Tungsten Flipping Weight | 108 |
| G-Shield Tungsten Punch Weight | 108 |
| Tungsten Hybrid Swing Head | 108 |
| TG Trigger Nail Weight | 108 |
| Saltwater | Page |
| Live Bait | 110 |
| Live Bait with Solid Ring | 110 |
| Live Bait Light Wire | 110 |
| Live Bait Light Wire with Solid Ring | 110 |
| Live Bait Heavy Duty | 111 |
| Live Bait Heavy Duty with Solid Ring | 111 |
| Live Bait Heavy Duty Circle | 112 |
| Nautilus Circle | 112 |
| Nautilus Circle with Solid Ring | 112 |
| Nautilus Light | 113 |
| Nautilus Circle Heavy Duty | 113 |
| Nautilus Circle Heavy Duty with Solid Ring | 113 |
| Super Nautilus Circle | 114 |
| Kraken Circle Monster | 114 |
| Kraken Outbarb Circle | 114 |
| Octopus Circle, 4x Strong , Straight Eye • NANO ALPHA | 115 |
| Octopus Circle, 4x Strong , Straight Eye (Inline-Point) • NANO ALPHA | 115 |
| O'Shaughnessy | 116 |
| Single Hook 53 Salt • NEW | 116 |
| Magic Eye Tuna Pluggin Hook HD | 117 |
| Magic Eye Tuna Plug 3X | 117 |
| Tuned Tuna Plug with Ring | 117 |
| Pluggin' Single HD- Ringed • NEW | 118 |
| Single 620 HD | 118 |
| Grouper Hook | 119 |
| Big Eye Circle | 119 |
| Tuned Tuna with Welded Eye | 120 |

TABLE OF CONTENTS

| Assist Hooks | Page |
|---|------------|
| Double Assist 520 | 122 |
| Assist 560 Double | 122 |
| Assist 540 Double Bait Plus | 122 |
| Assist 700 Double NSC | 123 |
| Assist 530 Double Short and Long | 124 |
| Assist Kinkai MS-Neo Double Short and Long | 124 |
| Assist Vertical Limit Short and Long | 125 |
| Assist Tsuranuki | 125 |
| Pluggin' Single HD- Assist - NEW | 126 |
| Assist 510 | 126 |
| Assist 550 Short | 127 |
| Tuned Assist HD | 127 |
| Magnum Assist | 127 |
| Steel Assist with Magic Eye Swivel | 128 |
| Assist 520, Ringed | 128 |
| Assist 620 Heavy Duty with Solid Ring | 129 |
| Assist 720 Heavy Duty | 129 |
| Rigs and Snells | Page |
| Drop Shot Rig | 132 |
| Single Egg Hooks, Barb on Shank Snell | 132 |
| Baitholder Snell | 132 |
| Kokanee Two Hook Snell | 133 |
| EWG Walleye Snell | 133 |
| Walleye Snell with Glow Bead | 133 |
| Walleye LG Two Hook Rig | 133 |
| Treble Stinger Rig, Wire Leader | 134 |
| Treble Stinger Rig, Fluorocarbon Leader | 134 |
| Catfish Rig | 134 |
| Catfish Rig Circle | 134 |
| Mooching Rig (Slip Tie) | 135 |
| Mooching Rig (Solid Tie) | 135 |
| Mooching Rig (Slip Tie) Barbless | 135 |
| Mooching Rig Big River Bait (Slip Tie) | 135 |
| Two Hook Bait Rig | 135 |
| Salmon/Steelhead Leader | 135 |
| Sockeye Rig | 136 |
| French Hook Snell | 136 |
| Top and Bottom Rig | 136 |
| Striper Rig | 137 |
| Striper Rig with Sliding Sinker Lock | 137 |
| Jigging Rig, Gold | 138 |
| Jigging Rig, Nickel, Smelt/Herring | 138 |
| Jigging Rig, Special Assorted Hook | 138 |
| Jigging Rig, Special Weighted Assorted Hook | 138 |
| Fly Hooks Executive Series | Page |
| S10 • Standard Down Eye | 141 |
| S10-B • Standard Down Eye Barbless | 141 |
| S10S • Straight Eye Dry | 141 |
| Jig Nymph • J20 Barbed | 141 |
| Jig Nymph • J20 Barbless | 141 |
| S25S Trout Stinger | 141 |
| R10-B • Retainer Bend Barbless | 141 |
| R17-B • Retainer Bend Barbless 3x Fine | 141 |
| R18-B • Barbless 2x Strong | 141 |

| Fly Hooks Executive Series, continued | Page |
|---|------------|
| R19-B • Retainer Bend Barbless | 141 |
| B10S • Stinger, 1x Strong Forged | 142 |
| B10S • Tournament Grade Wire, Nano Smooth Coat | 142 |
| B10S • Stinger Fluorescent | 142 |
| SBB26 Bend Back | 142 |
| C14S • Glo Bug | 142 |
| C13U • Keel Balance | 143 |
| C15-BV • Vertical eye, Emerger, Barbless | 143 |
| C12-BM • Barbless Midge, Large Eye | 143 |
| Traditional Series | Page |
| S11-4L2H • Steamer, 4x Long, 2x Strong | 143 |
| S11S-4L2H • Straight Eye Streamer | 143 |
| L11S-3H • Salmon and Steelhead 3x Strong | 143 |
| C12 • Down Eye Scud | 143 |
| C12U • Caddis | 143 |
| C12-B • Down Eye Scud Barbless, Red | 143 |
| T10-3H • Salmon Dry 1x Fine | 144 |
| T10-6H • Salmon Tapered Loop Up-Eye | 144 |
| Russian River Fly | 144 |
| Double 22 Medium Shank | 144 |
| Saltwater Series | Page |
| SL12-S 1x Short • Big Game, Wide Gap | 144 |
| J60 Crab Pattern | 144 |
| SL12S • Big Game, Wide Gap | 145 |
| SL4S • Bonefish | 145 |
| SL11-3H • 3x Strong | 145 |
| SS1S • Standard | 146 |
| SP11-3L3H • Perfect Bend | 146 |
| SC1S • Wide Gap | 146 |
| SC17 • Tarpon Fly | 146 |
| Terminal | Page |
| Spring Lock | 150 |
| Double Down Spring Lock | 150 |
| Silicone Stopper | 150 |
| Superline Swivel | 150 |
| Duo Lock Snap w/ Superline Swivel | 151 |
| Cross Lock Snap w/ Superline Swivel | 151 |
| Superline Split Ring | 151 |
| Superline Solid Ring | 151 |
| One Touch Blade Page | 152 |
| One Touch Blade (for Treble Hooks) | 152 |
| Tackle Storage | Page |
| G-Box Tuning & Terminal Utility Case - NEW | 154 |
| G-Box Quatro Joint Loc Case 250 - NEW | 154 |
| G-Box Adjustable Lure Case 3200 - NEW | 154 |
| G-Box 3200, Utility Case | 155 |
| G-Box 3200D Deep Utility Case | 155 |
| G-Box Reversible 3200 | 155 |
| G-Box 3500D, Deep Utility Case | 156 |
| G-Box 3600, Utility Case | 156 |
| G-Box Reversible 3600 | 156 |
| G-BOX 3700, Utility Case | 157 |
| G-Box 3700D Deep Utility Case | 157 |
| G-Box 3700D2 Deep Utility Case | 157 |
| G-Box 250, Duo Side Case, Slit Foam | 158 |

| Tackle Storage, continued | Page |
|---|-------------|
| G-Box 3200, Slit Foam Case | 158 |
| G-Box 3600, Slit Foam Case | 158 |
| G-Box 3200 and 3600 Double Sided Slit Foam Utility Case | 158 |
| G-Box 318SD Pocket Utility Case | 159 |
| G-Box 388DD Pocket Utility Case | 159 |
| G-Case 3000 | 159 |
| G-Case 7000 | 160 |
| G-Case 7000 Jig Compartment | 160 |
| G-Case 7000 Rod Stand | 160 |
| G-Case 7000 Shoulder Strap | 160 |
| G-Bag EWM 5000 H Tackle Bag | 161 |
| G-Bag EWM 300 Tackle Bag | 161 |
| G-Bag EWM 200 Tackle Bag | 162 |
| G-Bag EWM 100 Tackle Bag | 162 |
| Shoulder Bag Tackle Storage | 163 |
| Backpack Tackle Storage | 163 |
| Gear Duffel 30L | 163 |
| GSPECX PRECISION OPTICS | Page |
| GSPECX GENKAI • NEW | 166 |
| GSPECX BIWA • NEW | 167 |
| Tools and Accessories | Page |
| Fishing Pliers 6" | 170 |
| Fishing Pliers 7" | 170 |
| Fishing Pliers 9" 45 Degree | 170 |
| Micro Split Ring Plier | 170 |
| Ceramic Braid Scissors | 171 |
| Folding Braid Scissors w/ Split Ring Opener | 171 |
| Micro Fiber Towel | 172 |
| Finger Protector | 172 |
| Floats | Page |
| Firetip Float | 174 |
| Firetip Float Weighted | 174 |
| Firetip Egg Float Medium and Large | 174 |
| Knives | Page |
| EDC Knife GMKT2 | 176 |
| EDC Knife GMKT1 | 176 |
| EDC Knife GMKT4 | 176 |
| EDC Knife GMKT3 | 177 |
| Fillet Knife 6" | 177 |
| Fillet Knife w/ Spoon 7" | 177 |
| Fillet Knife 7.5" | 178 |
| Fillet Knife 9" | 178 |
| Knife Roll Bag | 178 |
| Apparel and Gear | Page |
| The Original Richardson 112 Trucker | 180 |
| Gamakatsu Legacy Trucker | 180 |
| Trucker Snapback Braid Hat White Navy | 180 |
| Trucker Snapback Braid Hat Green Charcoal | 180 |
| Richardson 5 Panel Trucker Hat | 180 |
| Premium Cuff Beanie | 180 |
| Trucker Hat Mesh Blk/Charcoal | 180 |
| Gamakatsu Richardson Trucker Hat | 180 |
| Flat Bill Triple Black | 180 |

| Apparel and Gear, continued | Page |
|---|-------------|
| Trucker Hat Mesh • NEW | 181 |
| Gamakatsu Sunshield • NEW | 181 |
| Gamakatsu Pro Staff T-Shirt Gray | 181 |
| Gamakatsu Pro Staff T-Shirt Navy | 181 |
| Gamakatsu Tuna T-Shirt | 181 |
| Gamakatsu Bass T-Shirt | 181 |
| Gamakatsu Trout T-Shirt | 181 |
| Gamakatsu G-Logo T-Shirt | 181 |
| Gamakatsu Simms SolarFlex® Hoodie | 182 |
| Gamakatsu Marsh Wear Pamlico Performance Hoodie | 182 |
| Gamakatsu Logo Heavyweight Hoodie | 182 |
| Gamakatsu Simms SolarFlex® Crewneck | 182 |
| Gamakatsu Retro Sweatshirt | 182 |
| LUXXE T-Shirt • NEW | 183 |
| LUXXE Long Sleeve T-Shirt • NEW | 183 |
| Decals | Page |
| G-Finesse Decals - Yellow, White, Solid | 184 |
| Tuna Boat Decal - White, Red, Blue | 184 |
| Embroidered Patch | 184 |
| Small Boat Decal | 184 |
| Large Boat Decal | 184 |
| Gamakatsu Carpet Decal | 184 |
| Representative Page | Page |
| Canada Regions - Gamakatsu and SPRO | 185 |
| Gamakatsu Regions | 187 |
| SPRO Regions | 187 |





*Gamakatsu continues to forge new paths by combining exciting new hook designs with industry-leading technology. The Gamakatsu **G-Finesse** and **G-Power** hooks are a perfect example of the brand's commitment to innovation.*

*The **G-Series** is a result of endless hours of product testing from some of the world's leading pro anglers. Every hook in this premium line was designed with a specific application, utilizing critical input from our professional fishing team. As a result, not only are these hooks, sharper, stronger and more durable, but they also create pro-type fishing advantages as seen in an increase in hook-ups, fewer lost fish, and overall superior fishability.*



The G-Finesse hooks are designed for technical and finesse fishing applications whereas the G-Power hooks are better suited for heavy cover and power techniques. Both G-Finesse and G-Power feature Tournament Grade Wire and Nano Smooth Coating.

Hook a few thousand bass a year and you know what works and what doesn't. That's exactly what Gamakatsu's pro team does year-in and year-out. Every cast, every hookset can be a game-changer... and that was the genesis of the **G-Series**. Designed and tested by bass fishing's top pro's, **G-Series** takes hook design, "sharp" and "strong" to new and unimagined levels of excellence. The top professionals' livelihoods depend on being the best and using the best equipment available and with G-Series, they have the competitive edge.

Gamakatsu's long held the reputation as the sharpest hooks on the water and the **G-Series** takes that to a whole new level. Using an ultra-strong material called **TGW (Tournament Grade Wire)**, that's thinner, stronger and sharper, Gamakatsu has been able to achieve what no other hook company has, the world's most effective fishing hooks.

But TGW is only part of the **G-Series** story. Gamakatsu's exclusive **Nano Smooth Coat** finish reduces resistance for superior penetration. A slicker, faster penetrating hook surface enhances the design and material attributes of the **G-Series**.

G-Series is more than an innovative, revolutionary, new hook material and finish. Gamakatsu's exclusive, proprietary design makes these singularly unique hooks even better!

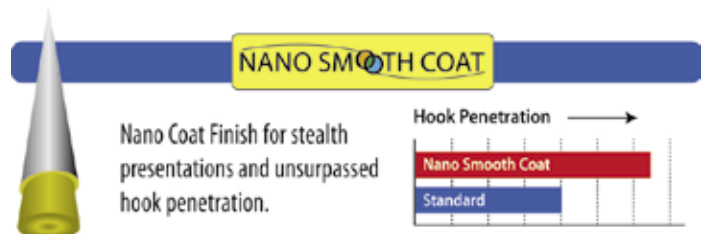

G-FINESSE



Gamakatsu
S# 347208
Tournament Grade Wire
Short Shank Treble MH

| | |
|-----|------|
| Qty | Size |
| 6 | 4 |

G
FINESSE



Tournament Grade

Gamakatsu[®]

G-FINESSE BY AARON MARTENS

G-Finesse . . . A Ground-Breaking Achievement In Hook Design

Gamakatsu entered the market on the promise of the sharpest hooks produced. It was Gamakatsu that created the “super sharp” hook category and continues to add new application-specific hooks to its offering every year.



G-Finesse Heavy Cover Worm

Aaron Martens Signature G-Finesse Heavy Cover Worm hook does what others can't. Extreme versatility.

Martens says it best, "This hook let's me do so much, easily the most versatile soft plastics hook on the market".

Featuring Aaron's custom designed keeper that holds plastics tight for endless casts without rips or tears. The rock solid keeper is made of non-corrosive tin, not plastic or lead, so it won't wear out or add unwanted weight. Like all G-Finesse hooks, tournament grade wire and Nano Smooth Coat finish perfect the design.

Available in sizes 2, 1, 1/0, 2/0, 3/0, 4/0.



G-Finesse Treble Hook

Thinner, Stronger, Sharper, Better.

Gamakatsu continues to expand its ground-breaking G-Finesse series hooks with the G-Finesse Treble Hook. Designed by Tournament pro, Aaron Martens, the G-Finesse Treble redefines “sharp” and “effective”.

Gamakatsu's G-Finesse Treble Hook is patterned after traditional O'Shaughnessy style hooks. Aaron has long been a proponent of the O'Shaughnessy hook style with its distinctive acute angle at the bottom of the hook. Martens believes the addition of the O'Shaughnessy bend, hooks and holds fish better than round bend designs. He should know, a past B.A.S.S. Angler of the Year, had three second place finishes in Bassmaster's Classics and is always in the hunt on the pro tours. When you fish as much as Aaron does, small details make a big difference. *The G-Finesse Treble Hooks is available in sizes 6,5,4,3,2, 1, 1/0. Nano Smooth Coat finish.*



G-Finesse Short Shank Treble Hook MH

G-Finesse for big, tough fish that live in the heaviest cover. Aaron Martens frequently chases them and he asked us for medium heavy G-Finesse treble to meet those needs.

We answered. The new G-Finesse Treble MH features a tougher medium heavy, tournament grade wire for additional strength. The same Nano Smooth Coat finish and short shank promote instant hook penetration. *Available in Sizes 6, 5, 4, 3, 2, 1, 1/0.*



G-Finesse Drop Shot Hook

Martens has been instrumental in the development of Gamakatsu's new G-Finesse Drop Shot Hook. Completely “pro-designed”, Gamakatsu's new G-Finesse series is a giant leap forward in fishing hook technology.



G-Finesse Feathered Treble MH

Based largely on the input of pro Aaron Martens, the G-Finesse feathered trebles feature either white or chartreuse premium feathers and complementary tinsel, hand selected by Martens to tempt even the most finicky fish. The G-Finesse feathered trebles feature TGW (Tournament-Grade Wire) construction, which is thinner, stronger and sharper than the standard wire. That means anglers will use fewer of them while ensuring better hook up percentages as the fishing day goes. To complete the job, they come with a Nano-Coat finish that makes penetration even easier. *Sizes 6, 4, 2, 1, 1/0*



G-FINESSE BY SHINICHI FUKAE

G-Finesse Swivel Shot Octopus

Drop-shot fishing for bass is nothing new but Gamakatsu's approach to it is. Our Swivel Shot eliminates line twist that's commonly associated with drop shotting and vastly improves rigging efficiency. Gamakatsu's produced a revolutionary "Twist Free" design using a premium swivel above the hook. The hook, a super-sharp Gamakatsu offset point Octopus hook, is strong enough to winch big bass out of slop --- another unique attribute of their Swivel Shot system. The Easy-Change weight system below the hook improves rigging efficiency and easy leader length adjustments without retying your rig. Pro Shinichi Fukae was instrumental in the development and testing of Gamakatsu's Swivel Shot and shared that it has been an essential element in his tournament success. Without a doubt, the Swivel Shot is an enormous leap forward in drop shot fishing that's sure to maximize angler's efficiency, increase hook-ups and land trophy-sized bass without the worry posed by conventional drop shot hooks and rigging.

Available in NS Black. Sizes: 2 - 3/0



Shinichi Fukae

G-Finesse Tricky Head.

From the master finesse magician himself, Shin Fukae, comes the Tricky Head jig head. Designed to be fished with the popular shaky head technique, it brings several additional advantages to the tackle box. The Tricky Head is snag free. The weighted lead head is uniquely shaped to remain vertical during presentation, allowing the jig to bounce in and around structure while the worm or swimbait is held firmly in place by a lockdown tin keeper. You've got to see it to believe it. *Available in black or plain lead, in sizes 1/16, 3/32, 1/8 or 3/16 oz.*



G-Finesse Swivel Shot Drop Shot

The original G-Finesse Swivel Shot changed the game and professional anglers were eager to play. Some, like Shin Fukae, recognized the G-Finesse advantage but didn't want to break from tradition entirely. The G-Finesse Swivel Shot Drop Shot features our top of the line Tournament Grade Wire Drop Shot hook. Both the hook and swivel system feature the benefits of a Nano Smooth Coat finish. *Available in sizes 2, 1, 1/0 and 2/0.*



G-Finesse Swivel Shot Worm

This design is the origination of a revolutionary new technique made possible by Gamakatsu's industry-changing G-Finesse series. Pro Staff Shinichi Fukae spent the over a year perfecting the concept and proving its power. We've combined our G-Finesse Worm Light w/ Tin Keeper hook with the G-Finesse Swivel Shot System to create the Swivel Shot Worm. Unique in form, function and finesse. Texas Rig the Swivel Shot Worm to be fished in and around cover. The light wire allows for threading extremely small diameter worms, held firmly in place by the near weightless, tin keeper. The hook also features our unique Nano Smooth Coat Finish. Adding the "twist-free" advantage of the Swivel Shot allows super fast rigging without tangles. You can be assured the presentation is always perfect, and that translates into more strikes and more bent rods.

Available in sizes 1, 1/0, 2/0. Nano Smooth Coat finish.



G-Finesse Weedless Wacky

Gamakatsu's Tournament-winning Pro Staffer, Shinichi Fukae, never rests. He worked tirelessly with Gamakatsu's engineers to develop the G-Finesse Weedless Wacky hook. Look closely and you'll see, it's not an ordinary weedless design. The weed guards are not plastic, they're titanium wire—solidly encased and directly molded to the hook shank. They won't come loose and they don't vibrate or add resistance. The extremely thin gauge wire retains its shape, yet is flexible enough to compress with even the gentlest nibbles. Bass won't feel a thing, until of course, the precision sharpened Gamakatsu hook does its job. The G-Finesse Weedless Wacky hook features Gamakatsu's exclusive Nano Smooth Coat finish to add stealth and reduce friction for effortless hook penetration. The hook itself features Tournament Grade Wire (TGW) that is a smaller diameter, yet stronger, than other Drop Shot hooks. *Available in sizes 2, 1, 1/0, 2/0 and 3/0*



G-Finesse Worm Light Wire

When conditions require finesse, the pros use G-Finesse Worm Light hooks. The light wire allows for threading of extremely small diameter worms with ease. Even the most fragile plastics are less likely to tear, saving on baits and increasing fishing time. The non-corrosive tin keeper doesn't add weight. Like all G-Finesse hooks, the Worm Light hook penetrates with significantly less force making them substantially more effective. *Available in sizes 1, 1/0, and 2/0, all with Nano Smooth Coat Finish.*



G-Finesse Cover Neko

By combining Gamakatsu's legendary quality and the design of fishing pro Shin Fukae, the perfect Neko hook now exists for this popular technique. The Cover Neko Hook consists of a shiner-style straight eye hook with an attached swivel to prevent line twist. There's also a strong, 90-degree wire keeper to lock plastics in place. Taken together, it's a tool that will let anglers easily fish through brush, laydowns and grass while maximizing hook-up percentages. *Available in sizes 1, 1/0 and 2/0.*



G-FINESSE BY SHINICHI FUKAE continued.

G-Finesse Gamakatsu Tournament Snap

Gamakatsu's Tournament Snap is better by design. Primarily used on plugs for bass, walleye, salmon, strippers, steelhead, trout, panfish and other species, Gamakatsu's Tournament Snap is stainless steel and enables a full range of movement, enhancing the effectiveness of whatever plug is used. Better yet, and unlike other plug snaps, Gamakatsu's Tournament Snap will not accidentally open. The clever design of the Tournament Snap stays closed at all times as the plug eye is threaded onto the snap. It's easy and effective! Tested extensively and used under rigorous tournament conditions. *Gamakatsu's Tournament Snaps are available in two sizes, (M) Medium and (L) Large.*



G-Finesse Jig Head Wacky

Gamakatsu's Jig Head Wacky is a vast improvement over other wacky jigs. The nickel/titanium weed guard is the first indication that Gamakatsu's raised the bass fishing bar. This weed guard is small but mighty as it effectively clears hazards yet maintains its shape and rigidity under the most demanding use. The jig head is an improvement as well. Better designed to resist snags the hook eye is recessed to prevent getting hung-up in structure. Even the hook is different, a custom addition that's based on a shiner hook but modified for the Jig Head Wacky. *Available in Black and Green Pumpkin. Sizes: 1/0-1/16, 1/0-3/32, 1/0-1/8, 1/0-3/16*



G-FINESSE BY BRENT EHRLER

G-Finesse Stinger

Tournament pro and Gamakatsu pro staff, Brent Ehler, developed and fine-tuned the G-Finesse Stinger for use with the popular Neko and Wacky rig techniques. It features Tournament Grade Wire (TGW) which is thinner and stronger than anything else on the market, and an application of Nano Smooth Coat to decrease penetration resistance. This hook can be perfectly positioned exactly where you want it, and even moved, without damaging the bait. *Available in size 6 through 1/0.*



G-Finesse Weedless Stinger

We heard from pro staff, Brent Ehler, and many others, that anglers were spending far too much time tying custom weed guards with wire or heavy monofilament on their Neko rigs. . .because they couldn't find the right finesse hook with the right weed guard already attached. Problem solved! The G-Finesse Stinger Weedless is just what the tournament trail needed. Titanium wire weed guard, Nano Smooth Coat and Tournament Grade Wire. *Available in size 6 through 1/0.*



G-Finesse Stinger Drop Shot

Gamakatsu and angler Brent Ehler introduce the G-Finesse Stinger Dropshot hook, featuring ultra-sharp Tournament Grade Wire (TGW) that's thinner, stronger, and sharper than traditional wire. The hook includes a welded wire keeper to secure plastics. Ehler praises its effectiveness for threading soft plastic bait on a dropshot rig. *Available in sizes 6, 4, 2, 1, and 1/0.*



G-FINESSE BY MIKE MCCLELLAND

Mike McClelland Inspired G-Finesse Hybrid Worm

The G-Finesse Hybrid Worm is the brainchild of pro-staffer, Mike McClelland. He's spent more than a few hours on the water, competing in over 234 tournaments, including 10 times at the Bassmaster Classic. Mike knows the subtleties of rigging worms and soft plastic like no one else, so he and Gamakatsu's designers combined the best of his current favorite Gamakatsu worm hook and incorporated a distinctive new acute hook angle to keep baits aligned



perfectly straight. Hence, the "Hybrid" name. The Nano Smooth Coat finish makes it easy to thread the thinnest finesse baits or the fattest Senkos with ease. Add industry-changing Tournament Grade Wire (TGW) to the package and things couldn't be more perfect. Take our word for it, or better yet, fish it yourself. *The G-Finesse Hybrid Worm is available in sizes 1/0 to 8/0.*



G-FINESSE BY AARON MARTENS

"Over my entire career fishing Gamakatsu I envisioned making the best finesse hook in the world. Gamakatsu's G-Finesse Series combine Ultra Sharp Tournament Grade Wire with Nano Smooth Technology for the ultimate in hook penetration. This technology will take my finesse fishing to a whole new level." ~ Aaron Martens



G-Finesse Drop Shot

Martens has been instrumental in the development of Gamakatsu's G-Finesse Drop Shot Hook. Completely "pro-designed", Gamakatsu's new G-Finesse series is a giant leap forward in fishing hook technology.

| SIZES | | 4 | 2 | 1 | 1/0 | 2/0 |
|------------------|----|-----------|-----------|-----------|-----------|-----------|
| Nano Smooth Coat | LS | 338208(6) | 338209(6) | 338210(6) | 338211(6) | 338212(6) |

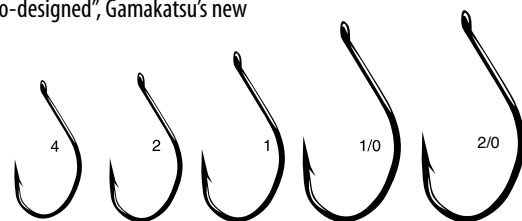

G-Finesse Heavy Cover Worm

Aaron Martens designed Finesse Heavy Cover, now available in Tournament Grade Wire (TGW), Nano Smooth Coat finish and Aaron's custom designed Tin Keeper.

| SIZES | | 2 | 1 | 1/0 | 2/0 | 3/0 | 4/0 |
|------------------|----|-----------|-----------|-----------|-----------|-----------|-----------|
| Nano Smooth Coat | LS | 357209(4) | 357210(4) | 357211(4) | 357212(4) | 357213(4) | 357214(4) |

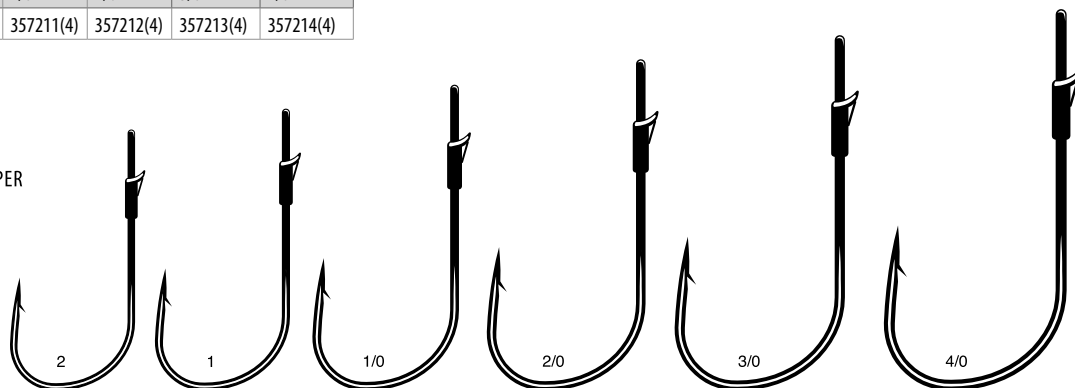
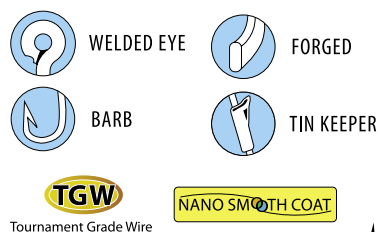

G-Finesse Short Shank Treble

Gamakatsu's G-Finesse Treble Hook is patterned after traditional O'Shaughnessy style hooks. Aaron has long been a proponent of the O'Shaughnessy hook style with its distinctive acute angle at the bottom of the hook. Martens believes the addition of the O'Shaughnessy bend, hooks and holds fish better than round bend designs.

| SIZES | | 6 | 5 | 4 | 2 | 1 | 1/0 |
|------------------|----|-----------|-------------|-----------|-----------|-----------|-----------|
| Nano Smooth Coat | LS | 339207(6) | 339207.5(6) | 339208(6) | 339209(6) | 339210(6) | 339211(6) |

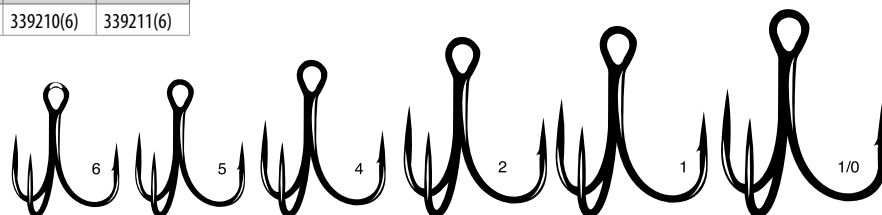
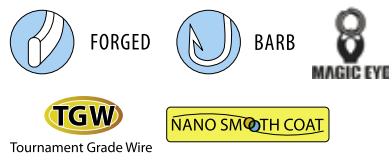

G-Finesse Short Shank Treble MH

Aaron Martens designed G-Finesse Treble MH features a tougher medium heavy Tournament Grade Wire (TGW) for additional strength and Nano Smooth Coat Technology for instant hook penetration.

| SIZES | | 6 | 5 | 4 | 3 | 2 | 1 | 1/0 |
|------------------|----|-----------|-------------|-----------|-------------|-----------|-----------|-----------|
| Nano Smooth Coat | LS | 347207(6) | 347207.5(6) | 347208(6) | 347208.5(6) | 347209(6) | 347210(6) | 347211(6) |

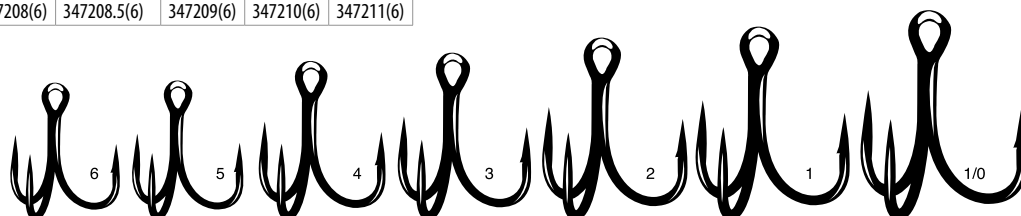
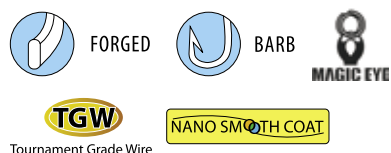

G-FINESSE BY AARON MARTENS

G-Finesse Feathered Treble MH

Based largely on the input of Major League Fishing pro Aaron Martens, the G-Finesse feathered trebles feature either white or chartreuse premium feathers and complementary tinsel, hand selected by Martens to tempt even the most finicky fish. The G-Finesse feathered trebles feature TGW (Tournament-Grade Wire) construction, which is thinner, stronger and sharper than the standard wire. That means anglers will use fewer of them while ensuring better hook up percentages as the fishing day goes. To complete the job, they come with a Nano-Coat finish that makes penetration even easier.



| SIZES | | 6 | 4 | 2 | 1 | 1/0 |
|------------------|-------------------|-----------------|--------------|--------------|--------------|--------------|
| Nano Smooth Coat | White/Tinsel | LS 417207-WT(2) | 417208-WT(2) | 417209-WT(2) | 417210-WT(2) | 417211-WT(2) |
| | Chartreuse/Tinsel | LS 417207-CT(2) | 417208-CT(2) | 417209-CT(2) | 417210-CT(2) | 417211-CT(2) |

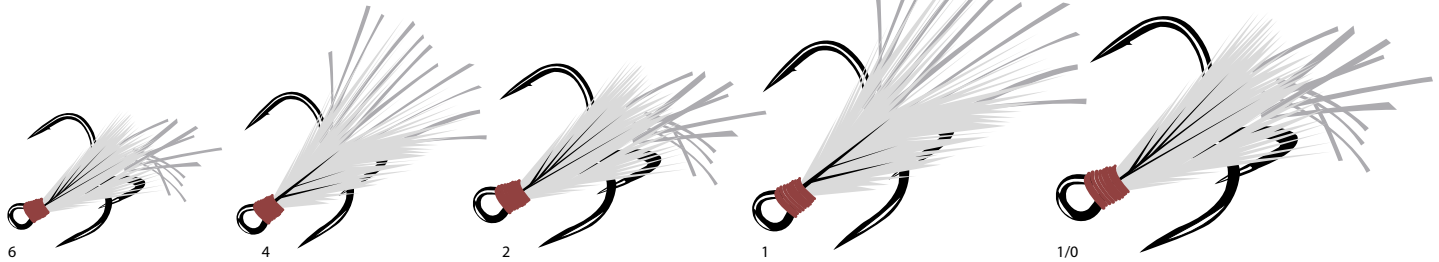

G-FINESSE BY SHINICHI FUKAE

Swivel Shot Drop Shot Features. Designed and endorsed by pro Shinichi Fukae

- A. High quality swivel above the hook to minimize line twist.
- B. Easy-Change Weight System.
- C. Nano Smooth Coat finish for stealth presentations and unsurpassed hook penetration.
- D. Tournament Grade Wire - hook points stays sharper longer.

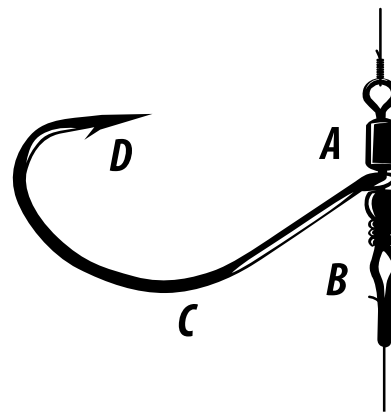

G-Finesse Swivel Shot Octopus

| SIZES | | 2 | 1 | 1/0 | 2/0 | 3/0 |
|----------|----|-----------|-----------|-----------|-----------|-----------|
| NS Black | LS | 316409(3) | 316410(3) | 316411(3) | 316412(3) | 316413(3) |

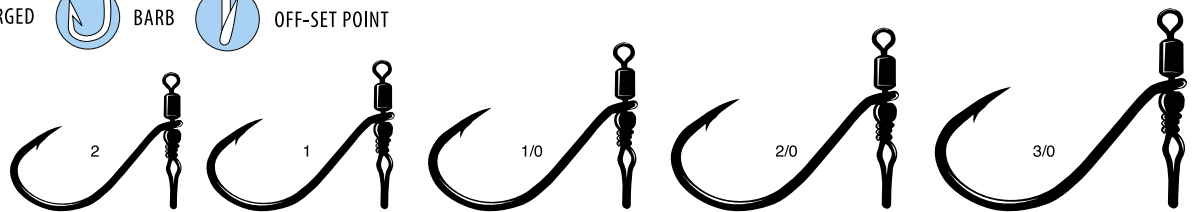

G-Finesse Swivel Shot Drop Shot

| SIZES | | 2 | 1 | 1/0 | 2/0 |
|------------------|----|-----------|-----------|-----------|-----------|
| Nano Smooth Coat | LS | 352209(3) | 352210(3) | 352211(3) | 352212(3) |



Tournament Grade Wire

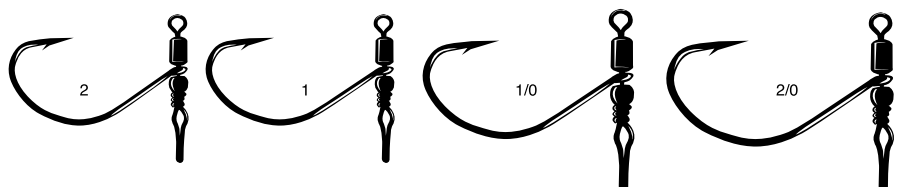

G-Finesse Swivel Shot Worm

| SIZES | | 1 | 1/0 | 2/0 |
|------------------|----|-----------|-----------|-----------|
| Nano Smooth Coat | LS | 362210(3) | 362211(3) | 362212(3) |



NANO SMOOTH COAT

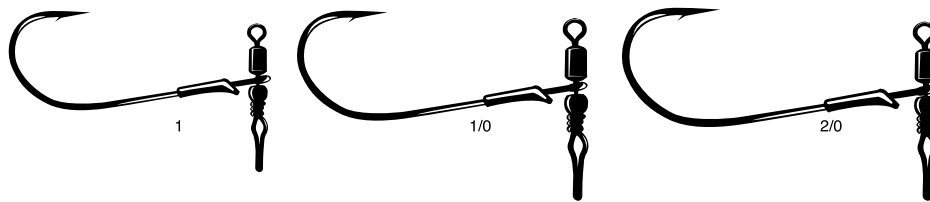

G-Finesse Weedless Wacky

| SIZES | | 2 | 1 | 1/0 | 2/0 | 3/0 |
|------------------|----|-----------|-----------|-----------|-----------|-----------|
| Nano Smooth Coat | LS | 367209(4) | 367210(4) | 367211(4) | 367212(4) | 367213(4) |



TGW

NANO SMOOTH COAT

Tournament Grade Wire

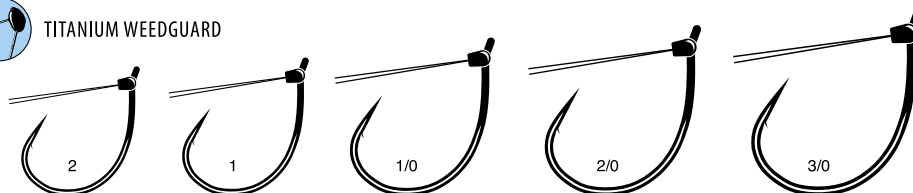

G-Finesse Jig Head Wacky

Gamakatsu's Jig Head Wacky is a vast improvement over other wacky jigs. The nickel/titanium weed guard is the first indication that Gamakatsu's raised the bass fishing bar. This weed guard is small but mighty as it effectively clears hazards yet maintains its shape and rigidity under the most demanding use. The jig head is an improvement as well. Better designed to resist snags the hook eye is recessed to prevent getting hung-up in structure. Even the hook is different, a custom addition that's based on a shiner hook but modified for the Jig Head Wacky. The result is a much higher ratio of hook-ups and landed fish than any other comparable brand.

| SIZES | | 1/0-1/16 | 1/0-3/32 | 1/0-1/8 | 1/0-3/16 |
|---------------|----|-------------------|-------------------|------------------|-------------------|
| Black | LS | 312411-BK-1/16(3) | 312411-BK-3/32(3) | 312411-BK-1/8(3) | 312411-BK-3/16(3) |
| Green Pumpkin | LS | 312411-GP-1/16(3) | 312411-GP-3/32(3) | 312411-GP-1/8(3) | 312411-GP-3/16(3) |



TGW

Tournament Grade Wire

NANO SMOOTH COAT

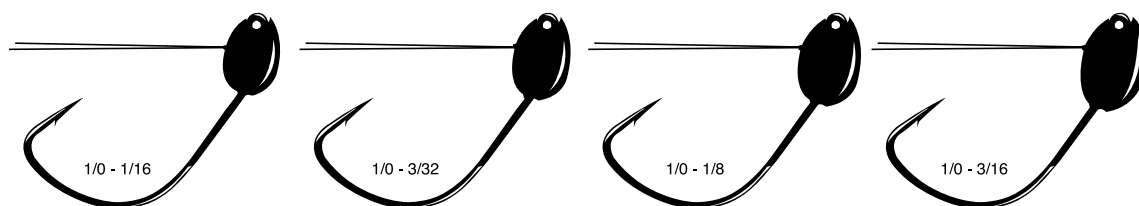

G-Finesse Tricky Head

From the master finesse magician himself, Shin Fukae, comes the Tricky Head jig head. Designed to be fished with the popular shaky head technique, it brings several additional advantages to the tackle box. The Tricky Head is snag free. The weighted lead head is uniquely shaped to remain vertical during presentation, allowing the jig to bounce in and around structure while the worm or swimbait is held firmly in place by a lockdown tin keeper. You've got to see it to believe it. Available in black or plain lead.

| SIZES | | 3/0-1/16 | 3/0-3/32 | 3/0-1/8 | 3/0-3/16 |
|------------|----|-------------------|-------------------|------------------|-------------------|
| Plain Lead | LS | 370413-1/16(3) | 370413-3/32(3) | 370413-1/8(3) | 370413-3/16(3) |
| Black | LS | 370413-BK-1/16(3) | 370413-BK-3/32(3) | 370413-BK-1/8(3) | 370413-BK-3/16(3) |



- A. Weedless Keel shape design glides effortlessly over and through structure
- B. Lock Down Keeper won't tear finesse plastics. Rig straight and secure every time

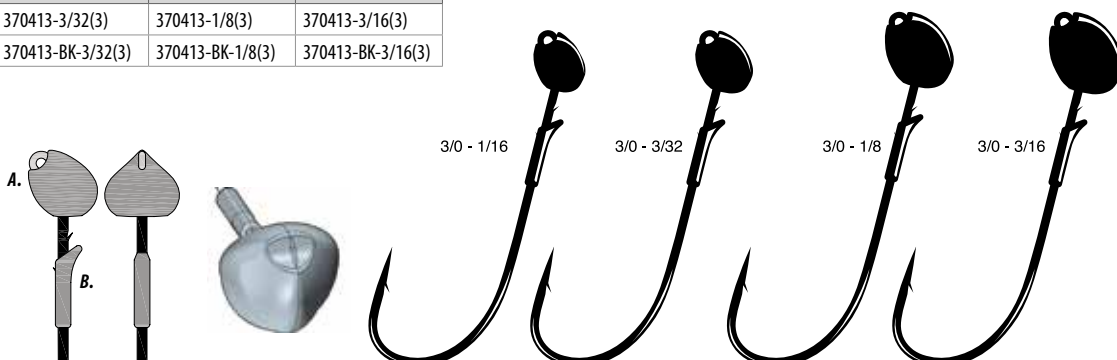

G-FINESSE BY SHINICHI FUKAE

G-Finesse Cover Neko

By combining Gamakatsu's legendary quality and the design of fishing pro Shin Fukae, the perfect Neko hook now exists for this popular technique. The Cover Neko Hook consists of a shiner-style straight eye hook with an attached swivel to prevent line twist. There's also a strong, 90-degree wire keeper to lock plastics in place. Taken together, it's a tool that will let anglers easily fish through brush, laydowns and grass while maximizing hook-up percentages.



| SIZES | 1 | 1/0 | 2/0 |
|----------|--------------|-----------|-----------|
| NS Black | LS 423410(3) | 423411(3) | 423412(3) |

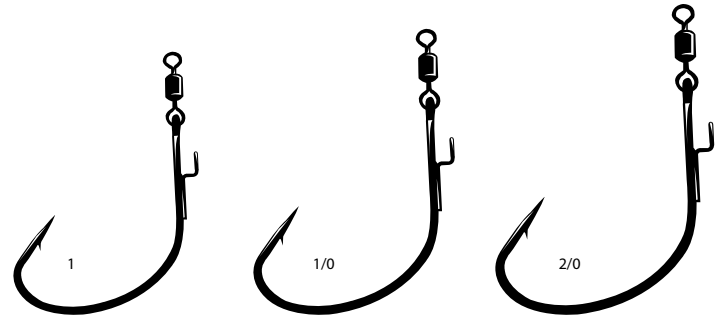

G-Finesse Worm Light Wire

When conditions require finesse, the pros use G-Finesse Worm Light Wire hooks. The light wire allows for threading of extremely small diameter worms with ease. Even the most fragile plastics are less likely to tear, saving on baits and increasing fishing time. The non-corrosive tin keeper doesn't add weight. Like all G-Finesse hooks, the Worm Light hook penetrates with significantly less force making them substantially more effective.

| SIZES | 1 | 1/0 | 2/0 |
|------------------|--------------|-----------|-----------|
| Nano Smooth Coat | LS 358210(4) | 358211(4) | 358212(4) |

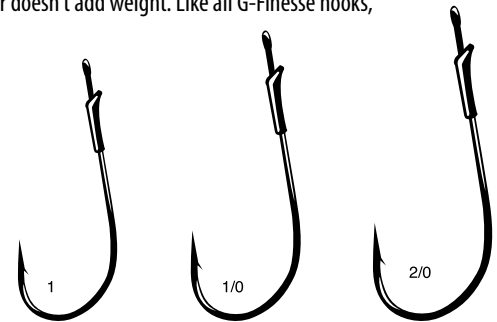

G-Finesse Tournament Snap

| SIZES | Medium (60 lb.) | Large (80 lb.) |
|-------|-----------------|----------------|
| LS | 333000-M(10) | 333000-L(10) |

Tournament Snap design intensifies the lures swimming action

High quality stress relieved stainless steel.

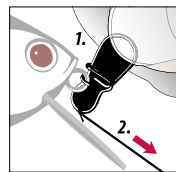

- 1. TWIST & CLICK** - Hook the open end of the Tournament Snap inside the lure eye. Twist and click into place.
- 2. PULL** - Keep you line tight and pull at a 90 degree angle away from the lure to finish setting.



G-FINESSE BY MIKE MCCLELLAND

Gamakatsu Hybrid Worm is the definitive choice for all of my soft plastic rigs on tour. The unique hybrid design helps me hook and land more fish than ever before. When combined with Tournament Grade Wire and Nano Smooth Coat technology, Hybrid Worm is the ultimate fish catching machine.

~ Mike McClelland



G-Finesse Hybrid Worm

The G-Finesse Hybrid Worm is the brainchild of pro-staffer; Mike McClelland. He's spent more than a few hours on the water, competing in over 234 tournaments, including 10 times at the Bassmaster Classic. Mike knows the subtleties of rigging worms and soft plastic like no one else, so he and Gamakatsu's designers combined the best of his current favorite Gamakatsu worm hook and incorporated a distinctive new acute hook angle to keep baits aligned perfectly straight. Hence, the "Hybrid" name. The Nano Smooth Coat finish makes it easy to thread the thinnest finesse baits or the fattest Senkos with ease. Add industry-changing Tournament Grade Wire (TGW) to the package and things couldn't be more perfect. Take our word for it, or better yet, fish it yourself.

| SIZES | 1/0 | 2/0 | 3/0 | 4/0 | 5/0 | 6/0 | 7/0 | 8/0 |
|------------------|--------------|-----------|-----------|-----------|-----------|-----------|-----------|-----------|
| Nano Smooth Coat | LS 366211(4) | 366212(4) | 366213(4) | 366214(4) | 366215(4) | 366216(4) | 366217(4) | 366218(4) |



FORGED



BARB



Tournament Grade Wire

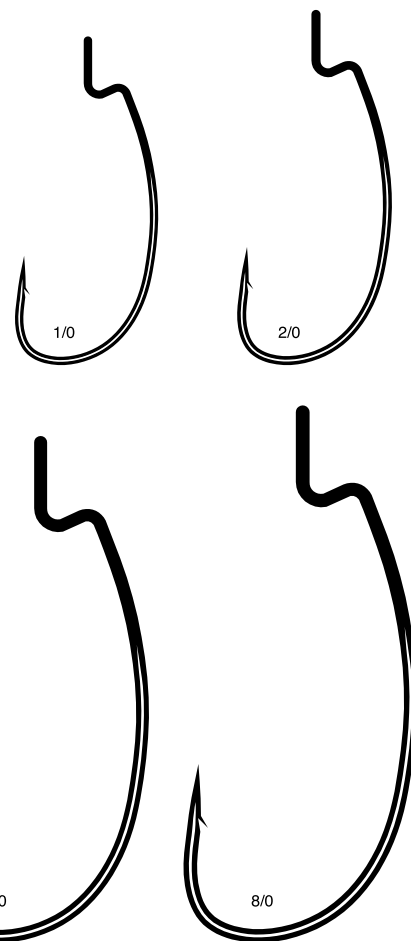

G-FINESSE BY BRENT EHRLER



G-Finesse Stinger

Tournament pro and Gamakatsu pro staff, Brent Ehrler, developed and fine-tuned the G-Finesse Stinger for use with the popular Neko and Wacky rig techniques. The G-Finesse Stinger follows in the footsteps of similar, game-changing G-Finesse hooks engineered by Gamakatsu. It features Tournament Grade Wire (TGW) which is thinner and stronger than anything else on the market, and an application of Nano Smooth Coat to decrease penetration resistance. This hook can be perfectly positioned exactly where you want it, and even moved, without damaging the bait. When the bite is tough, G-Finesse opens new ways to stick it to 'em.

| SIZES | 6 | 4 | 2 | 1 | 1/0 |
|------------------|--------------|-----------|-----------|-----------|-----------|
| Nano Smooth Coat | LS 374207(6) | 374208(6) | 374209(6) | 374210(6) | 374211(6) |

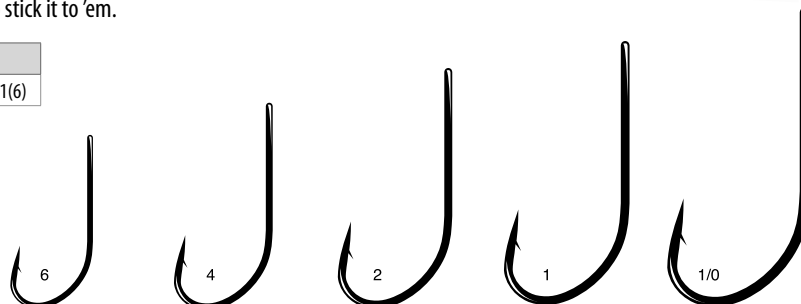

G-Finesse Weedless Stinger

We heard from pro staff, Brent Ehrler, and many others, that anglers were spending far too much time tying custom weed guards with wire or heavy monofilament on their Neko rigs... because they couldn't find the right finesse hook with the right weed guard already attached. Problem solved! The G-Finesse Weedless Stinger is just what the tournament trail needed. Titanium wire weed guard, Nano Smooth Coat and Tournament Grade Wire.

| SIZES | 6 | 4 | 2 | 1 | 1/0 |
|------------------|--------------|-----------|-----------|-----------|-----------|
| Nano Smooth Coat | LS 375207(4) | 375208(4) | 375209(4) | 375210(4) | 375211(4) |

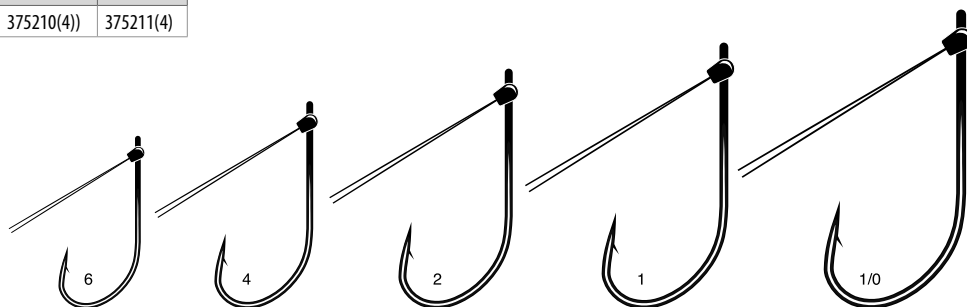

G-Finesse Stinger Drop Shot

Gamakatsu and veteran professional angler Brent Ehrler expand on the groundbreaking line of G-Finesse Stinger hooks. The G-Finesse Stinger Dropshot hook features ultra-sharp Tournament Grade Wire (TGW) that's thinner, stronger, and sharper than traditional wire, while also incorporating a welded wire keeper to lock your favorite plastics in place. Ehrler is excited about the new addition to the G-Finesse Stinger lineup and is looking forward to utilizing it at the highest level of competitive angling. "This new hook is just what I wanted to thread a soft plastic bait all the way up on the hook on a dropshot rig. The keeper holds the plastic in place and the Stinger design made from Tournament Grade Wire can't be beat," Brent Ehrler.

| Sizes | 6 | 4 | 2 | 1 | 1/0 |
|----------|--------------|-----------|-----------|-----------|-----------|
| NS Black | LS 461407(5) | 461408(5) | 461409(5) | 461410(5) | 461411(5) |

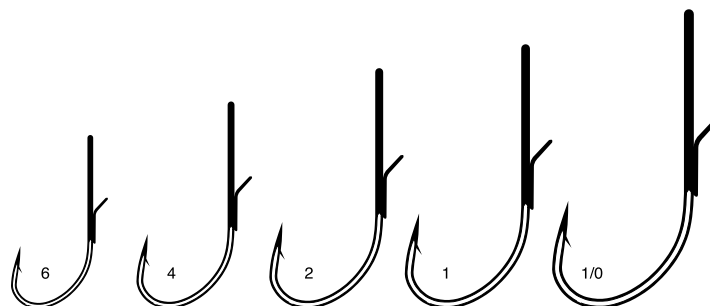



G-POWER

Gamakatsu[®]

G POWER

G-POWER BY AARON MARTENS



G-Power Heavy Cover Flip and Punch

Designed by Aaron Martens, Gamakatsu has developed the new G-Power Heavy Cover Flip and Punch Hook. A step up from the G-Finesse Heavy Cover Hook, for serious flipping and punching with Heavy fluorocarbon and braid. The TGW (Tournament Grade Wire) hook, paired with its welded eye, make this the strongest Heavy Cover hook in Gamakatsu's G-Series lineup. Ideal for larger baits and weights, punching through grass mats and flipping into heavy timber. G-Power Flip and Punch ideally matches to all types of cover and able to withstand extreme conditions.

| SIZES | 2/0 | 3/0 | 4/0 | 5/0 |
|------------------|--------------|-----------|-----------|-----------|
| Nano Smooth Coat | LS 392212(4) | 392213(4) | 392214(4) | 392215(4) |

- WELDED EYE
- FORGED
- BARB
- TIN KEEPER

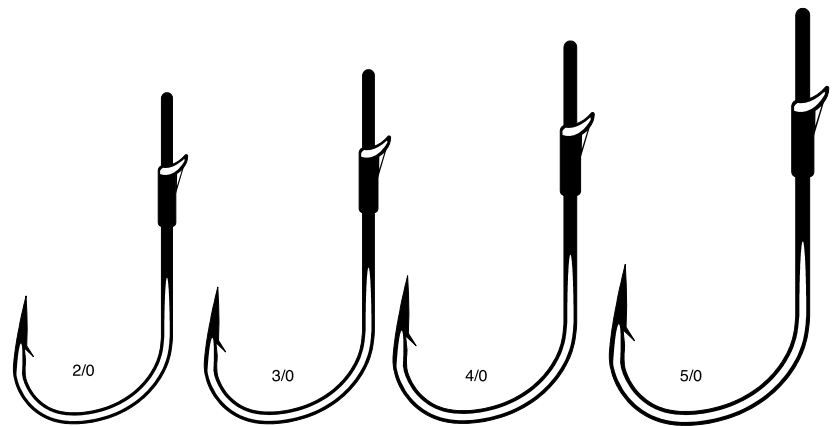

G-Power Stinger Trailer

The new G-Power Stinger Trailer Hook brilliance comes from Gamakatsu's famous B10S series of fly hooks and the expertise of Professional Bass angler Aaron Martens. The Stinger Trailer has a strategically designed eye angle. This allows the hook to run straight through the water column at any retrieve speed which produces more hookups. To make this stinger hook even more efficient, Gamakatsu paired it with a silicone stopper to be placed just above the eye, preventing the hook from sliding over the barb of the main hook. Featuring Tournament Grade Wire, Nano Smooth Coat finish and the new silicone stopper, the G-Power Stinger Trailer Hook is a game-changer.

| SIZES | 2 | 1 | 1/0 |
|------------------|--------------|-----------|-----------|
| Nano Smooth Coat | LS 411209(6) | 411210(6) | 411211(6) |

- EYE
- FORGED
- BARB





G-POWER BY CHRIS JOHNSTON



G-Power Outsider Treble

Designed in conjunction with two time Bassmaster AOY Chris Johnston, the Outsider Treble is engineered for anglers demanding maximum penetration and corrosion resistance in high pressure environments. Featuring Nano Alpha Technology for 2x better hook penetration and 4x better corrosion resistance, this new treble hook also incorporates an outward angled point to improve hookup ratios. A large barb enhances holding power, keeping fish pinned during aggressive fights. The Nano Alpha coating further reduces friction for faster, more efficient penetration.

| Sizes | 6 | 5 | 4 | 3 | 2 | 1 | 1/0 |
|------------|---------------|--------------|------------|--------------|------------|------------|------------|
| Nano Alpha | LS 473207 (6) | 473207.5 (6) | 473208 (6) | 473208.5 (6) | 473209 (6) | 473210 (6) | 473211 (6) |



FORGED



BARB

NANO ALPHA

NEW

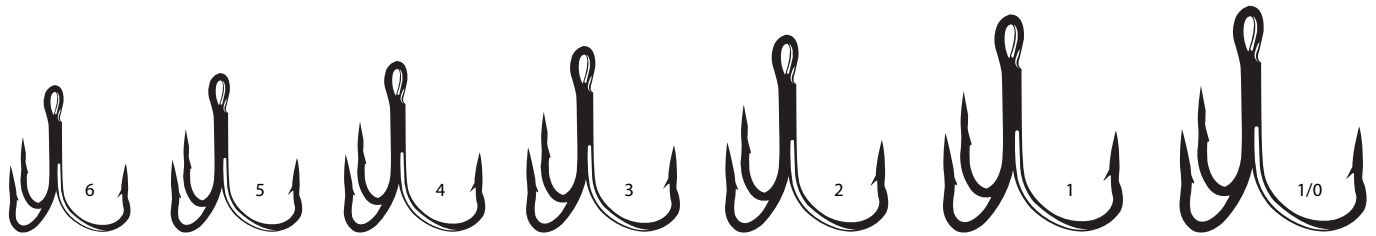



TREBLE HOOKS



Galakatsu®

Treble SP Medium Heavy Hypershield

The Treble SP Medium Heavy Hypershield features TGW (Tournament Grade Wire) which is thinner, stronger and sharper than standard wire. Hypershield coating dramatically increases corrosion resistance allowing anglers to spend more time fishing and less time changing out old rusty hooks. Hypershield also keeps hooks sharper longer, making it the perfect treble hook for big, toothy fish. The Treble SP MH is paired with the iconic ME (Magic Eye), making it extremely simple to replace existing hooks on to any split ring of a crankbait or plug.

| SIZES | | 6 | 4 | 2 | 1 | 1/0 | 2/0 |
|--------------|----|-----------|-----------|-----------|-----------|-----------|-----------|
| Hyper Shield | LS | 390807(6) | 390808(6) | 390809(5) | 390810(5) | 390811(4) | 390812(4) |

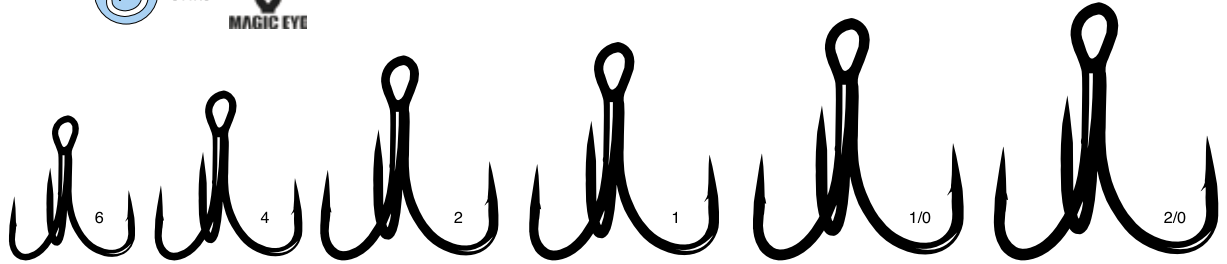

Treble SP XH

Replacing factory hooks on inshore plugs, jigs and spoons with Gamakatsu's heavy-duty SP XH treble hooks is an instant upgrade. The Tournament Grade Wire (TGW) construction is thinner, stronger and sharper than standard wire, making these Gamakatsu's strongest treble ever. Plus, the short shank design eliminates leverage that can lead to worn jaws and pulled hooks.

| SIZES | | 3 | 2 | 1 | 1/0 | 2/0 | 3/0 | 4/0 | 5/0 | 6/0 |
|----------|----|-------------|-----------|-----------|-----------|-----------|-----------|-----------|-----------|-----------|
| Tin | LS | 391508.5(5) | 391509(5) | 391510(5) | 391511(4) | 391512(4) | 391513(4) | 391514(4) | 391515(4) | 391516(4) |
| NS Black | LS | | | | | 391412(4) | 391413(4) | 391414(4) | 391415(4) | 391416(4) |



Tournament Grade Wire

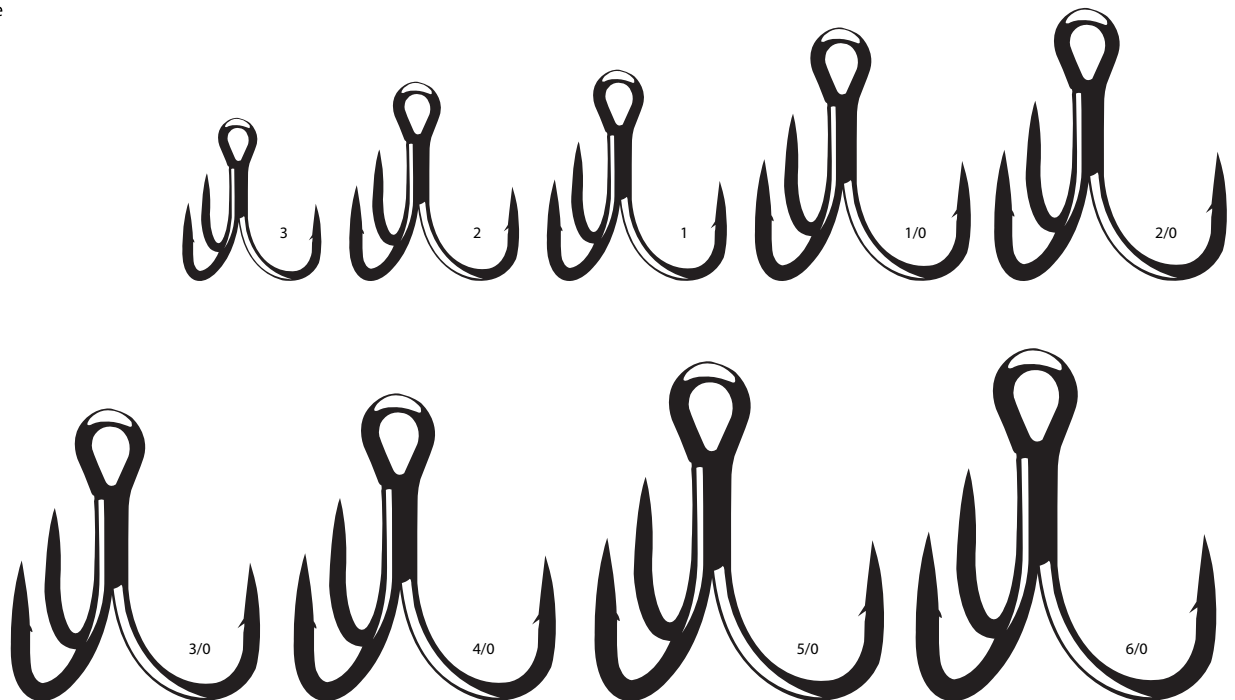

Treble S-SP XH • NANO ALPHA

Engineered for maximum penetration and holding power, the Gamakatsu Treble S-SP XH Nano Alpha is built to handle aggressive predators. Featuring an extra-heavy construction, larger barb, and short shank design, it delivers secure hooksets while reducing leverage that can lead to lost fish. Gamakatsu's slick Nano Alpha coating reduces friction for faster penetration, making it an excellent choice for upgrading plugs, casting baits, jigs, and spoons targeting hard-fighting species.

NEW

| SIZES | | 1/0 | 2/0 | 3/0 | 4/0 | 5/0 | 6/0 |
|------------|----|-----------|-----------|-----------|-----------|-----------|-----------|
| NANO ALPHA | LS | 494211(4) | 494212(4) | 494213(4) | 494214(4) | 494215(4) | 494216(4) |



EYE



FORGED



BARB

NANO ALPHA

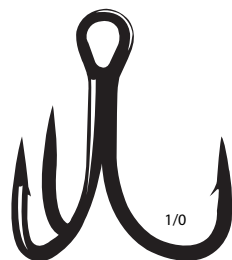

1/0

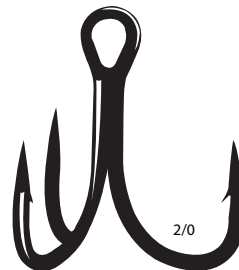

2/0

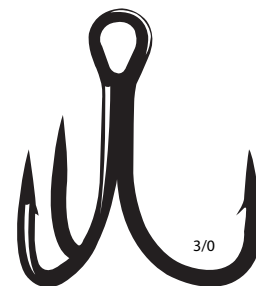

3/0

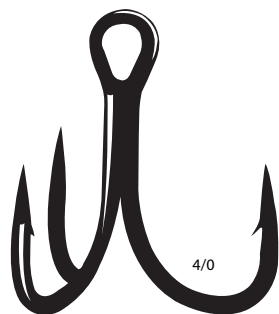

4/0

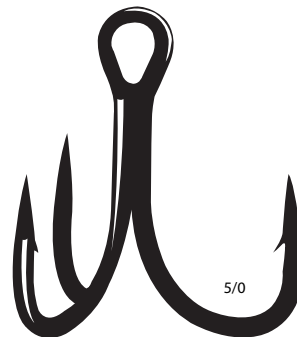

5/0

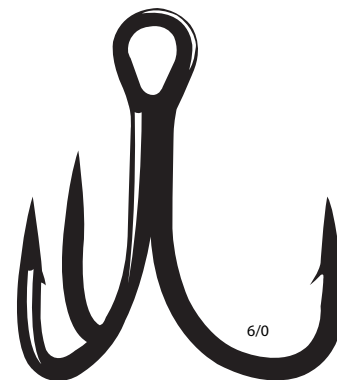

6/0

Treble S-SP XH • HYPERSHIELD

Built for anglers targeting powerful saltwater gamefish, the Gamakatsu Treble S-SP XH Hyper Shield delivers the strength and reliability needed for demanding inshore and offshore applications. Its extra-heavy construction and short shank design help reduce leverage during the fight, minimizing pulled hooks when trophy fish surge boatside. Finished with Gamakatsu's corrosion-resistant Hyper Shield coating, this premium treble is ideal for upgrading factory hooks on plugs, spoons, and jigs fished in harsh saltwater environments.

| SIZES | 1/0 | 2/0 | 3/0 | 4/0 | 5/0 | 6/0 |
|-------------|--------------|-----------|-----------|-----------|-----------|-----------|
| HYPERSHIELD | LS 494811(4) | 494812(4) | 494813(4) | 494814(4) | 494815(4) | 494816(4) |

NEW

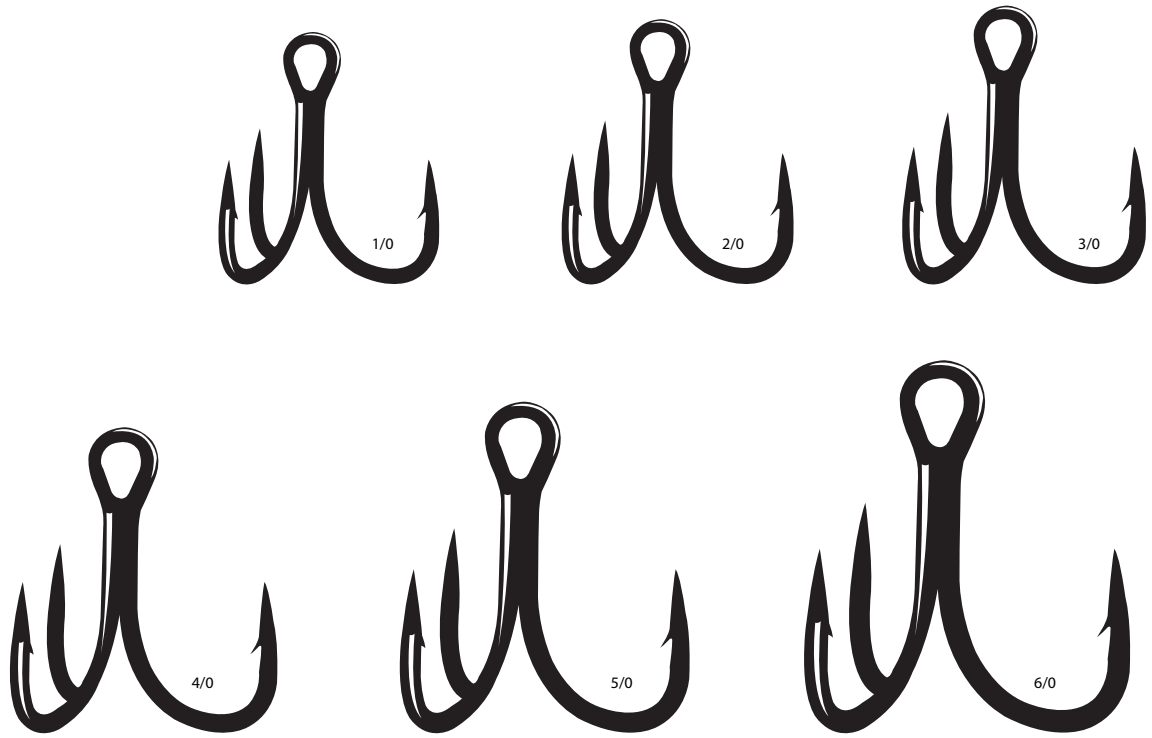

Treble Round Bend

When you want to get serious about your hard baits our Round Bend Treble is the standard worldwide.

| SIZES | 12 | 10 | 8 | 7 | 6 | 5 | 4 | 3 | 2 | 1 | 1/0 | 2/0 |
|--------------------|----|---------------|---------------|---------------|-----------|---------------|------------|---------------|------------|----------|----------|----------|
| NS Black | LS | | 47406(12) | 47406.5(12) | 47407(12) | 47407.5(10) | 47408(10) | 47408.5(8) | 47409(8) | 47410(8) | | |
| | 25 | | 47406-25 | 47406.5-25 | 47407-25 | 47407.5-25 | 47408-25 | 47408.5-25 | 47409-25 | 47410-25 | | |
| Tin | LS | | 47006(12) | | 47007(12) | | 47008(10) | | 47009(9) | 47010(7) | 47011(6) | 47012(5) |
| Bronze | LS | 47104(12) | 47105(12) | 47106(12) | 47107(12) | 47107.5(11) | 47108(10) | 47108.5(9) | 47109(9) | 47110(7) | 47111(6) | 47112(5) |
| | 25 | | 47106-25 | | 47107-25 | | 47108-25 | | 47109-25 | 47110-25 | 47111-25 | 47112-25 |
| Red | LS | 47304(10) | 47305(10) | 47306(10) | | 47307(10) | 47307.5(9) | 47308(9) | 47308.5(8) | 47309(8) | | |
| Fluorescent Orange | LS | 47604-OR (10) | 47605-OR (10) | 47606-OR (10) | | 47607-OR (10) | | 47608-OR (10) | | | | |
| Fluorescent Pink | LS | 47604-P (10) | 47605-P (10) | 47606-P (10) | | 47607-P (10) | | 47608-P (10) | | | | |
| Chartreuse | LS | 47604-C (10) | 47605-C (10) | 47606-C (10) | | 47607-C (10) | | 47608-C (10) | | | | |

NEW COLORS



FORGED



BARB

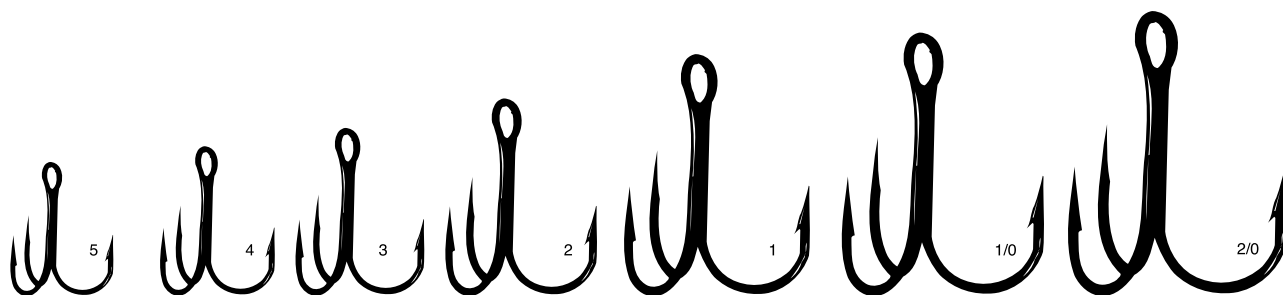

Treble Round Bend Barbless

| SIZES | 8 |
|--------|--------------|
| Bronze | LS 64106(12) |



FORGED



BARBLESS



Treble 2x Strong, Round Bend

Anytime your situation requires a stout Round Bend Treble our 2X strong is the answer. The perfect hook for hard charging Stripers or Peacock Bass.

| SIZES | 4 | 2 | 1 | 1/0 |
|----------|--------------|----------|----------|----------|
| NS Black | LS 57408(11) | 57409(9) | 57410(7) | 57411(6) |
| Red | LS 57308(9) | 57309(8) | 57310(7) | 57311(5) |



FORGED



BARB



Treble Short Shank, (Magic Eye), Round Bend

Developed for the discerning hard bait angler. Featuring our award winning "Magic Eye". When rigged, the Short Shank hook points run parallel to the bait creating a perfect balance point. This is the ideal treble hook for optimal lure performance.

| SIZES | 6 | 4 | 2 | 1/0 |
|----------|---------------|------------|-----------|-----------|
| NS Black | LS 298407(12) | 298408(11) | 298409(9) | 298411(6) |



FORGED



BARB

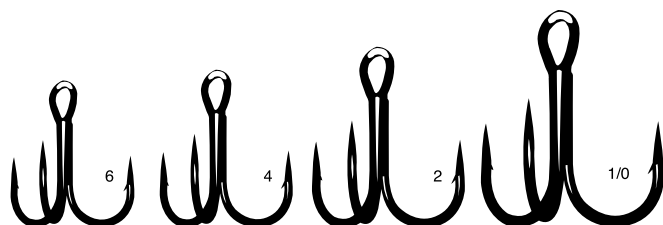

Treble Big Bait Special, Round Bend

The Treble Big Bait Special Round Bend hook was designed specifically to battle with large freshwater game fish such as Pike, Muskie, and Salmon. These treble hooks are made with 3x strong wire and feature Nano Smooth Coat technology along with the exclusive Magic Eye for easy rigging. Available in sizes 1 - 5/0 for use on a wide range of hardbaits. The Treble Big Bait Special hook is also a great choice as a replacement treble hook for larger glidebaits and swimbaits in bass fishing applications.

| SIZES | | 1 | 1/0 | 2/0 | 3/0 | 4/0 | 5/0 |
|------------------|----|-----------|-----------|-----------|-----------|-----------|-----------|
| Nano Smooth Coat | LS | 476210(6) | 476211(5) | 476212(5) | 476213(4) | 476214(4) | 476215(4) |

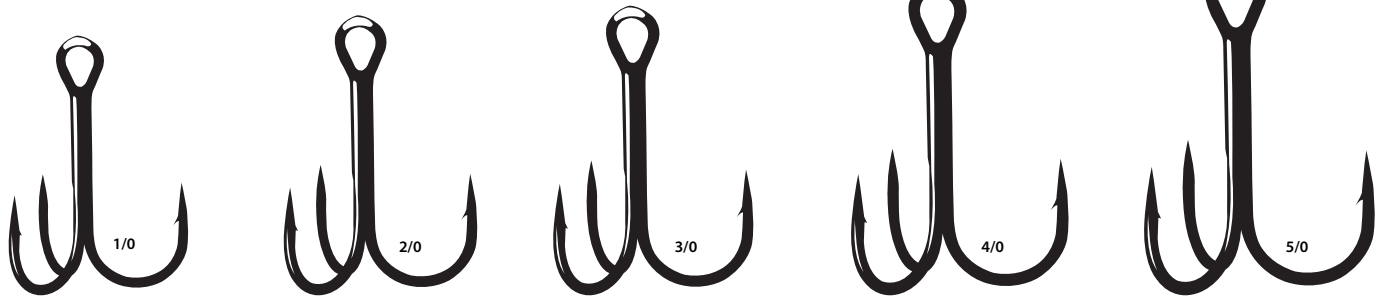
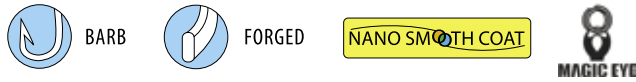

Treble Extra Wide Gap (EWG)

| SIZES | | 6 | 4 | 2 |
|----------|----|-----------|-----------|----------|
| Bronze | LS | 77107(12) | 77108(11) | 77109(9) |
| NS Black | LS | 77407(12) | 77408(11) | 77409(9) |
| Red | LS | 77307(10) | 77308(9) | 77309(8) |



Treble EWG, Short Shank, (Magic Eye)

For crankbaits of all types --- there's nothing better --- it's the perfect replacement hook. First, we opened the points of this treble up slightly for even better hooking performance. The Short Shank EWG Treble converts those fish that slash at your bait into sure hook-ups. The shorter shank and wide gap design provides less room for fish to throw the hook. In fact, this attribute actually wedges the fish between the hook and the crankbait...it's the ultimate in fish holding, which means fish landing performance. That's not all. It also features Gamakatsu's exclusive "Magic Eye" that makes changing hooks a breeze. The hook's inline points run parallel to the bait creating a perfect balance point so your crankbaits run true.

| SIZES | | 6 | 4 | 2 | 1 | 1/0 |
|----------|----|-----------|-----------|-----------|-----------|-----------|
| NS Black | LS | 330407(6) | 330408(6) | 330409(6) | 330410(6) | 330411(6) |

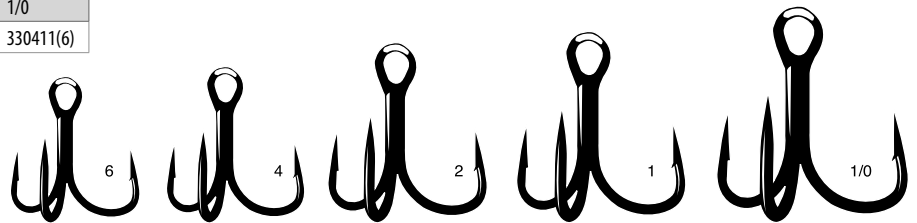

Treble EWG, Short Shank, 2X Strong (Magic Eye)

All the attributes of the Short Shank EWG Treble just beefed up to 2X Strong dimensions for tackle-busting big game species like striper, musky and peacock bass.

| SIZES | | 6 | 4 | 2 | 1 | 1/0 |
|----------|----|-----------|-----------|-----------|-----------|-----------|
| NS Black | LS | 317407(6) | 317408(6) | 317409(6) | 317410(6) | 317411(6) |

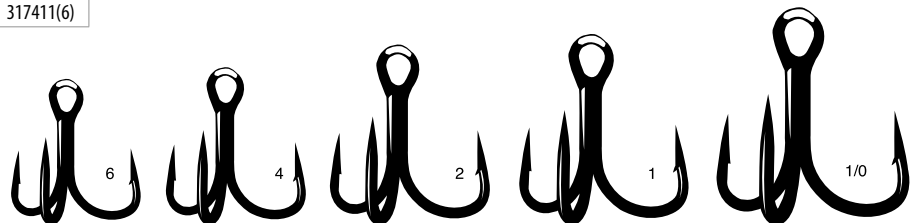

Treble 4x Strong

| SIZES | 3/0 | 5/0 |
|-------|-------------|----------|
| Tin | LS 62013(4) | 62015(3) |



FORGED



BARB

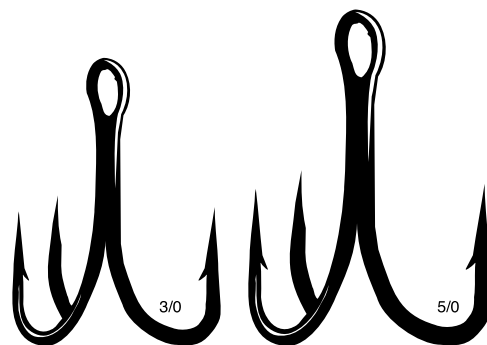

Feathered Treble

Add one of our Feathered Trebles to the back of any topwater bait and watch your lure come to life. Beautifully hand tied on our premium Round Bend treble.

| SIZES | | 6 | 4 | 2 |
|----------|-------------------|-----------------|--------------|--------------|
| NS Black | (White and White) | LS 216407-WW(2) | 216408-WW(2) | 216409-WW(2) |
| | (White and Red) | LS 216407-WR(2) | 216408-WR(2) | 216409-WR(2) |



FORGED



BARB



Double 22 Medium Shank

Medium shank length designed with a straight eye manufactured in durable Nickel Silver Black.

| SIZES | 10 |
|----------|---------------|
| NS Black | LS 302405(12) |



FORGED



BARB



EWG Double

The perfect hook for all your soft bodied frogs. The angle of the hook makes it ride weedless. The wide gap increases your hook up ratio.

| SIZES | 3/0 | 4/0 |
|----------|--------------|-----------|
| NS Black | LS 226413(3) | 226414(3) |



FORGED



BARB

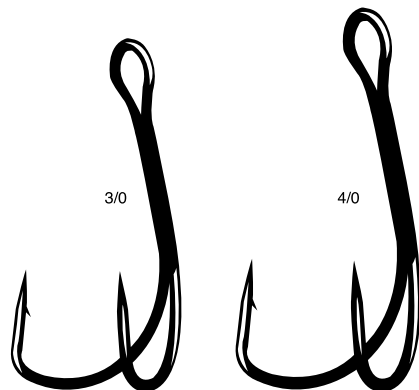





ALL PURPOSE HOOKS

Spinnaker[®]

Octopus

Our most versatile hook, known for its durability and strength. The Octopus hook comes in a wide variety of colors and finishes including fluorescent.

| SIZES | 14 | 12 | 10 | 8 | 6 | 4 | 2 | 1 | 1/0 | 2/0 | 3/0 | 4/0 | 5/0 | 6/0 | 7/0 | 8/0 | 9/0 | 10/0 | |
|---------------------|-----|-----------|-----------|-----------|-------------|-------------|-------------|-------------|-------------|-------------|-------------|-------------|-----------|-----------|-----------|-----------|-----------|-----------|-----------|
| Nickel | LS | | | 02005(10) | 02006(10) | 02007(10) | 02008(10) | 02009(8) | 02010(8) | 02011(6) | 02012(6) | 02013(6) | 02014(6) | 02015(6) | 02016(6) | 02017(6) | 02018(6) | 02019(5) | 02020(5) |
| | 25 | | | 02006-25 | 02007-25 | 02008-25 | 02009-25 | 02010-25 | 02011-25 | 02012-25 | 02013-25 | 02014-25 | 02015-25 | 02016-25 | 02017-25 | 02018-25 | 02019-25 | 02020-25 | |
| | 100 | | | | 02007-100 | 02008-100 | 02009-100 | 02010-100 | 02011-100 | 02012-100 | 02013-100 | 02014-100 | 02015-100 | 02016-100 | 02017-100 | | | | |
| Bronze | LS | | | 02106(10) | 02107(10) | 02108(10) | 02109(8) | 02110(8) | 02111(6) | 02112(6) | 02113(6) | 02114(6) | 02115(6) | | | | | | |
| | 25 | | | 02106-25 | 02107-25 | 02108-25 | 02109-25 | 02110-25 | 02111-25 | 02112-25 | 02113-25 | 02114-25 | 02115-25 | | | | | | |
| | 100 | | | 02106-100 | 02107-100 | 02108-100 | 02109-100 | 02110-100 | 02111-100 | 02112-100 | 02113-100 | 02114-100 | 02115-100 | | | | | | |
| NS Black | LS | 02403(10) | 02404(10) | 02405(10) | 02406(10) | 02407(10) | 02408(10) | 02409(8) | 02410(8) | 02411(6) | 02412(6) | 02413(6) | 02414(6) | 02415(6) | 02416(6) | 02417(6) | 02418(6) | 02419(5) | 02420(5) |
| | 25 | | | | 02406-25 | 02407-25 | 02408-25 | 02409-25 | 02410-25 | 02411-25 | 02412-25 | 02413-25 | 02414-25 | 02415-25 | 02416-25 | 02417-25 | | | |
| | 100 | | | | 02406-100 | 02407-100 | 02408-100 | 02409-100 | 02410-100 | 02411-100 | 02412-100 | 02413-100 | 02414-100 | 02415-100 | 02416-100 | 02417-100 | 02418-100 | 02419-100 | 02420-100 |
| Red | LS | 02303(10) | 02304(10) | 02305(10) | 02306(10) | 02307(10) | 02308(10) | 02309(8) | 02310(8) | 02311(6) | 02312(6) | 02313(6) | 02314(6) | 02315(6) | 02316(6) | 02317(6) | 02318(6) | 02319(5) | 02320(5) |
| | 25 | | | | 02306-25 | 02307-25 | 02308-25 | 02309-25 | 02310-25 | 02311-25 | 02312-25 | 02313-25 | 02314-25 | 02315-25 | 02316-25 | 02317-25 | | | |
| | 100 | | | | 02306-100 | 02307-100 | 02308-100 | 02309-100 | 02310-100 | 02311-100 | 02312-100 | 02313-100 | 02314-100 | 02315-100 | 02316-100 | 02317-100 | | | |
| Green | LS | | | | 02306-G(10) | 02307-G(10) | 02308-G(10) | 02309-G(8) | | | | | | | | | | | |
| | 25 | | | | 02306-G-25 | 02307-G-25 | 02308-G-25 | 02309-G-25 | | | | | | | | | | | |
| | 100 | | | | 02306-G-100 | 02307-G-100 | 02308-G-100 | 02309-G-100 | | | | | | | | | | | |
| Blue | LS | | | | 02306-B(10) | 02307-B(10) | 02308-B(10) | 02309-B(8) | | | | | | | | | | | |
| | 25 | | | | 02306-B-25 | 02307-B-25 | 02308-B-25 | 02309-B-25 | | | | | | | | | | | |
| | 100 | | | | 02306-B-100 | 02307-B-100 | 02308-B-100 | 02309-B-100 | | | | | | | | | | | |
| F-Red | LS | | | | 02606-FR(7) | 02607-FR(7) | 02608-FR(7) | 02609-FR(6) | 02610-FR(6) | 02611-FR(5) | 02612-FR(5) | 02613-FR(5) | | | | | | | |
| Chartreuse | LS | | | | 02606-C(7) | 02607-C(7) | 02608-C(7) | 02609-C(6) | 02610-C(6) | 02611-C(5) | 02612-C(5) | 02613-C(5) | | | | | | | |
| | 25 | | | | 02606-C-25 | 02607-C-25 | 02608-C-25 | 02609-C-25 | | | | | | | | | | | |
| F-Pink | LS | | | | 02606-P(7) | 02607-P(7) | 02608-P(7) | 02609-P(6) | 02610-P(6) | 02611-P(5) | 02612-P(5) | 02613-P(5) | | | | | | | |
| F-Orange | LS | | | | 02606-OR(7) | 02607-OR(7) | 02608-OR(7) | 02609-OR(6) | 02610-OR(6) | 02611-OR(5) | 02612-OR(5) | 02613-OR(5) | | | | | | | |
| Glow | LS | | | | 02606-GL(7) | 02607-GL(7) | 02608-GL(7) | 02609-GL(6) | 02610-GL(6) | | | | | | | | | | |
| F-Green | LS | | | | 02606-LG(7) | 02607-LG(7) | 02608-LG(7) | 02609-LG(6) | | | | | | | | | | | |
| F-Purple | LS | | | | 02606-PU(7) | 02607-PU(7) | 02608-PU(7) | 02609-PU(6) | | | | | | | | | | | |
| Ultra Violet | LS | | | | 02606-UV(7) | 02607-UV(7) | 02608-UV(7) | 02609-UV(6) | 02610-UV(6) | 02611-UV(5) | 02612-UV(5) | 02613-UV(5) | | | | | | | |
| Nano Alpha | LS | | | | | | 02208(10) | 02209(8) | 02210(8) | 02211(6) | 02212(6) | 02213(6) | 02214(6) | 02215(6) | | | | | |



NANO ALPHA

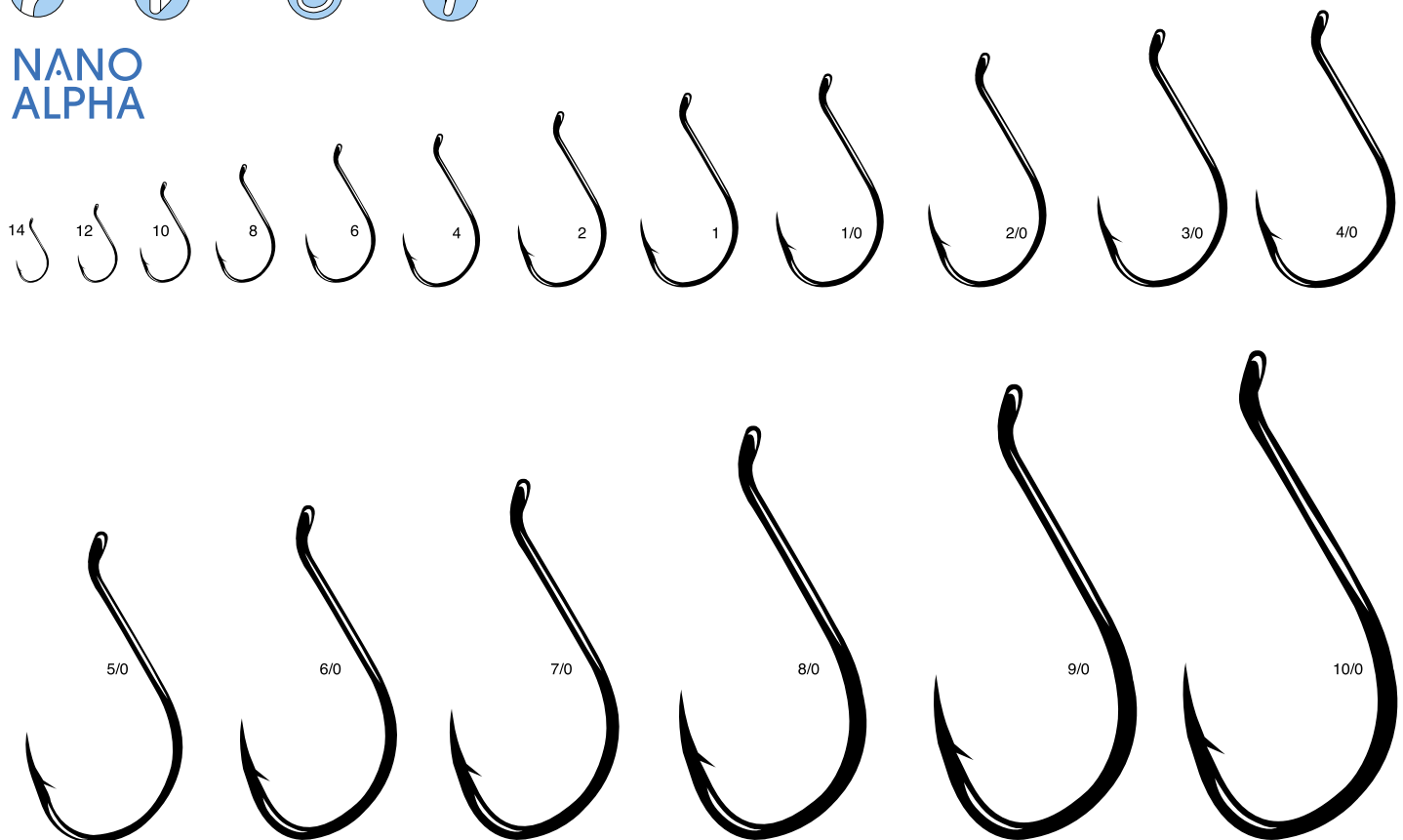

Walleye And Steelhead Assortment

| SIZES | 8 | 6 | 4 | 2 | |
|------------|----|-------|-------|-------|-------|
| Assortment | 25 | 02506 | 02507 | 02508 | 02509 |

5 Colors:

- Green
- Blue
- Red
- Bronze
- Black

5 hooks per color, 25 hooks total

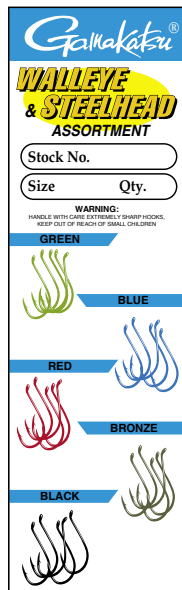

Fluorescent Walleye And Steelhead Assortment

| SIZES | 8 | 6 | 4 | 2 | |
|------------|----|-------|-------|-------|-------|
| Assortment | 20 | 02706 | 02707 | 02708 | 02709 |

5 Colors:

- F-Red
- F-Pink
- F-Orange
- Chartreuse
- Glow

4 hooks per color, 20 hooks total

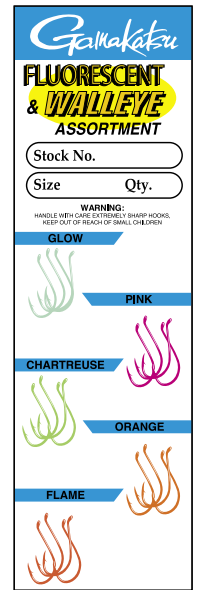

Bead Hook

The Bead Hook is a revolutionary fishing hook designed specifically for bead fishing, a popular technique used to target salmon and steelhead. Made from Gamakatsu's Tournament Grade Wire (TGW), the Bead Hook features a thinner, stronger, and sharper wire that easily penetrates the hard jaw plates of these powerful fish. Its Nano Alpha Coating offers superior corrosion protection, ensuring the hook's longevity and also provides a super slick finish for improved penetration. With a longer shank and wider hook gap, the Bead Hook increases the chances of landing fish, especially those that are stronger and more prone to jumping. Equipped with a needlepoint for optimal penetration, this hook is a must-have for anglers seeking to catch the largest salmon and steelhead in their waters.

| SIZES | | 6 | 4 | 2 | 1 | 1/0 | 2/0 | 3/0 | 4/0 | 5/0 |
|------------|-------|-----------|-----------|-----------|-----------|-----------|-----------|-----------|------------|------------|
| Nano Alpha | LS | 459207(8) | 459208(8) | 459209(6) | 459210(6) | 459211(5) | 459212(5) | 459213(5) | 459214 (5) | 459215 (5) |
| | 25 pk | 459207-25 | 459208-25 | 459209-25 | 459210-25 | 459211-25 | 459212-25 | 459213-25 | | |

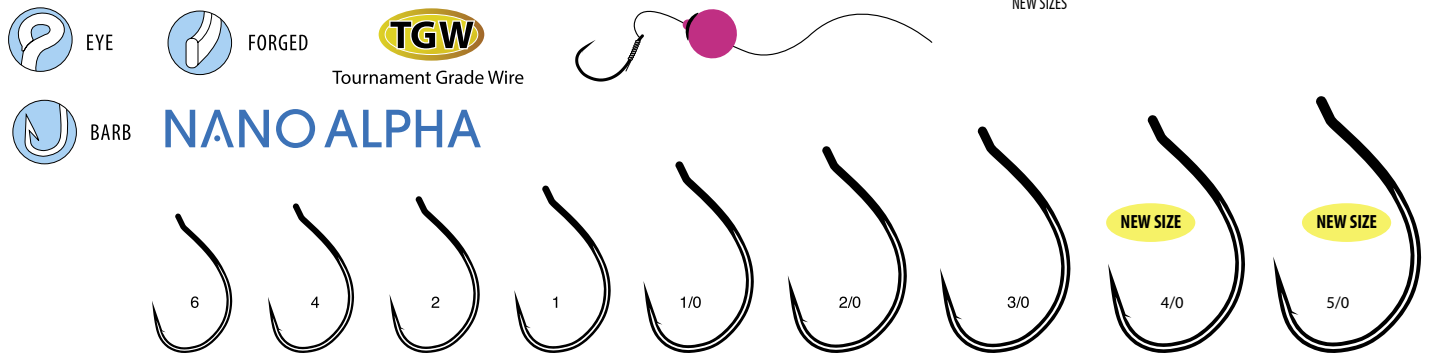

TGW OCTOPUS

The TGW (Tournament Grade Wire) Octopus utilizes Gamakatsu's ultra-strong TGW wire that's thinner, sharper and stronger than the standard wire and ensures the hook point stays sharper, longer. This is combined with Gamakatsu's Nano Smooth Coat finish to provide a faster, deeper penetrating hook. The hook's all-purpose shape and forged construction makes it ideal for a variety of presentations. The TGW Octopus Hook also features an upturned eye to ease snelling or knotting directly to the eye.

| SIZES | 6 | 4 | 2 | 1 | 1/0 | 2/0 | |
|------------------|----|-----------|-----------|-----------|-----------|-----------|-----------|
| Nano Smooth Coat | LS | 424207(8) | 424208(8) | 424209(6) | 424210(6) | 424211(5) | 424212(5) |

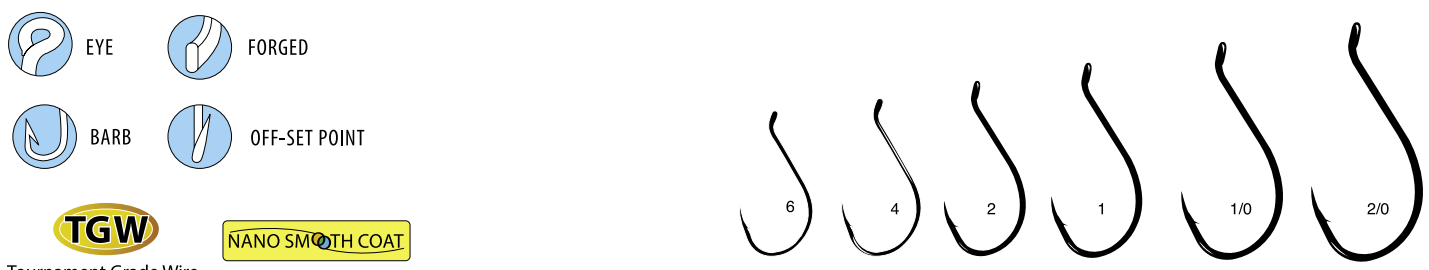

Tournament Grade Wire

Octopus Light

Gamakatsu answered the call for a fine wire Octopus hook, the Octopus Light for use in drop shot and trout fishing. Gamakatsu's Octopus Light features an offset beak point for optimal penetration with bait or plastics. The smaller diameter hook wire enhances hook penetration and is a certain advantage when fishing timid or light-biting fish.

| SIZES | 8 | 6 | 4 | 2 | 1 | 1/0 | 2/0 | 3/0 |
|----------|---------------|------------|------------|-----------|-----------|-----------|-----------|-----------|
| NS Black | LS 341406(10) | 341407(10) | 341408(10) | 341409(8) | 341410(8) | 341411(6) | 341412(6) | 341413(6) |
| Red | LS 341306(10) | 341307(10) | 341308(10) | 341309(8) | 341310(8) | 341311(6) | 341312(6) | 341313(6) |

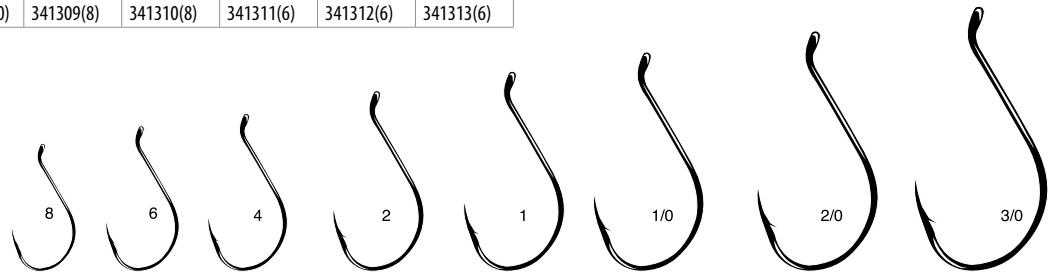
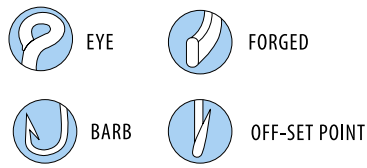

Octopus Barbless

Specially designed bend allows the hook to penetrate quickly and hold, while still complying with the barbless hook regulations.

| SIZES | | 4 | 2 | 1 | 1/0 | 2/0 | 3/0 | 4/0 | 5/0 | 6/0 | 7/0 | 8/0 |
|----------|-----|-----------|-----------|-----------|-----------|-----------|-----------|-----------|-----------|----------|----------|----------|
| Nickel | LS | 75008(10) | 75009(8) | 75010(8) | 75011(6) | 75012(6) | 75013(6) | 75014(6) | 75015(6) | 75016(6) | 75017(6) | 75018(6) |
| | 25 | 75008-25 | 75009-25 | 75010-25 | 75011-25 | 75012-25 | 75013-25 | 75014-25 | 75015-25 | 75016-25 | 75017-25 | |
| | 100 | 75008-100 | 75009-100 | 75010-100 | 75011-100 | 75012-100 | 75013-100 | 75014-100 | 75015-100 | | | |
| Red | LS | 75308(10) | 75309(8) | 75310(8) | 75311(6) | 75312(6) | 75313(6) | 75314(6) | 75315(6) | | | |
| | 25 | 75308-25 | 75309-25 | 75310-25 | 75311-25 | 75312-25 | 75313-25 | 75314-25 | 75315-25 | | | |
| | 100 | 75308-100 | 75309-100 | 75310-100 | 75311-100 | 75312-100 | 75313-100 | 75314-100 | 75315-100 | | | |
| NS Black | LS | 75408(10) | 75409(8) | 75410(8) | 75411(6) | 75412(6) | 75413(6) | 75414(6) | 75415(6) | | | |
| | 25 | 75408-25 | 75409-25 | 75410-25 | 75411-25 | 75412-25 | 75413-25 | 75414-25 | 75415-25 | | | |

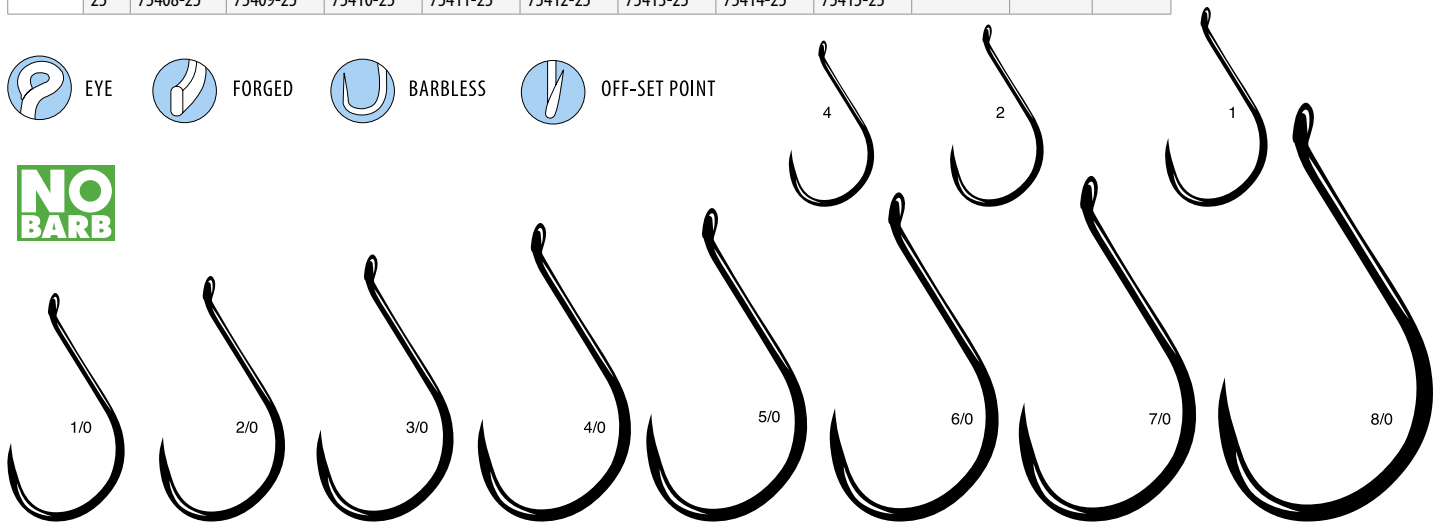

Octopus Straight Eye

West coast anglers love salmon. Salmon love herring. Herring love to rip and tear apart when you rig them with traditional hooks. Hence, the reason we designed the Octopus Straight Eye hook. The ultra-thin, yet ultra-strong, wire slides through soft baits without damaging the tender tissue. The hook eye is narrower and smoother too, so it can slide through as well. The result is a herring with that perfect spin, followed by a chrome bright chinook or coho in the net shortly thereafter.

| SIZES | 8 | 6 | 4 | 2 | 1 | 1/0 | 2/0 | 3/0 | 4/0 |
|----------|---------------|------------|------------|-----------|-----------|-----------|-----------|-----------|-----------|
| NS Black | LS 387406(10) | 387407(10) | 387408(10) | 387409(8) | 387410(8) | 387411(6) | 387412(6) | 387413(6) | 387414(6) |
| | 25 387406-25 | 387407-25 | 387408-25 | 387409-25 | 387410-25 | 387411-25 | 387412-25 | 387413-25 | 387414-25 |

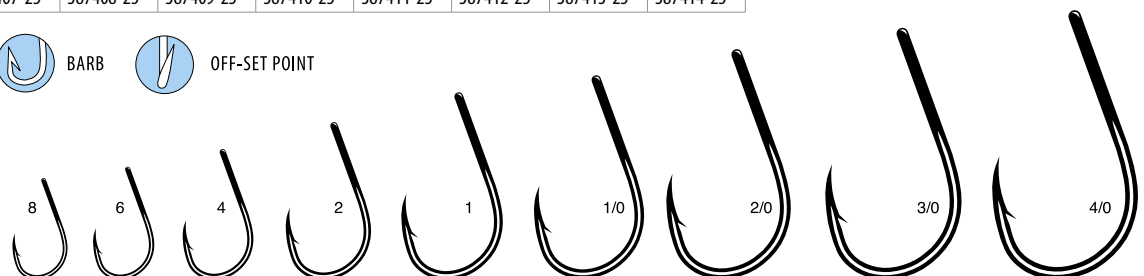

Octopus Straight Eye, 4x Strong

One of the more versatile hooks in our line up, this hook is built to handle big fish. Used for everything from Catfish to Tarpon, the offset beak point penetrates quickly and can be used on either bigger live baits or for chunk baits.

| SIZES | | 1/0 | 2/0 | 3/0 | 4/0 | 5/0 | 6/0 | 7/0 | 8/0 | 9/0 | 10/0 |
|------------|----|----------|----------|----------|----------|----------|----------|----------|----------|----------|----------|
| NS Black | LS | 98411(6) | 98412(6) | 98413(6) | 98414(6) | 98415(6) | 98416(6) | 98417(6) | 98418(6) | 98419(5) | 98420(5) |
| NS Black | 25 | | | | | 98415-25 | 98416-25 | 98417-25 | 98418-25 | | |
| Nano Alpha | LS | | 98212(6) | 98213(6) | 98214(6) | 98215(6) | 98216(6) | | | | |



NANO ALPHA

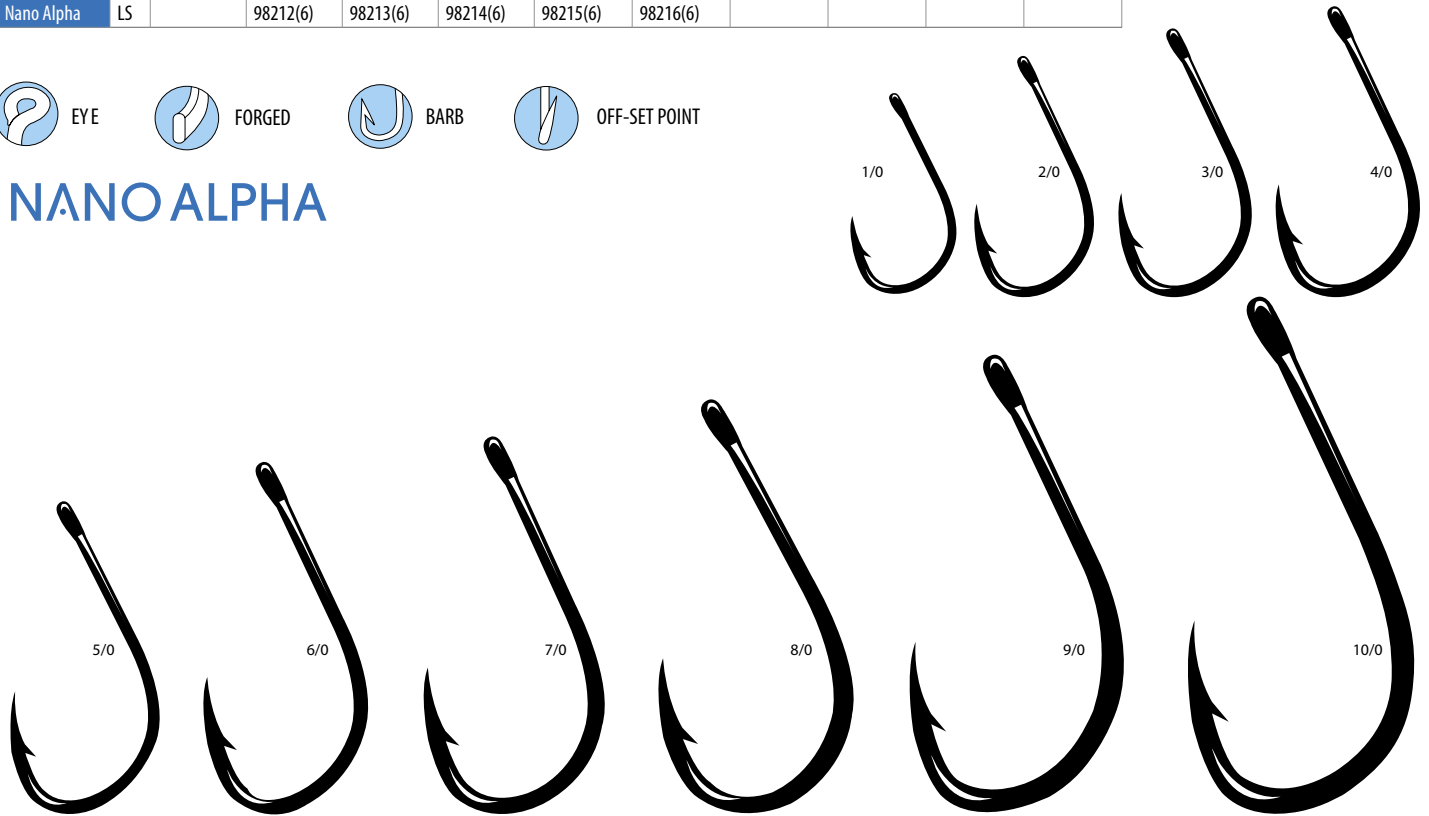

Octopus Straight Eye, 4x Strong (Inline-point)

Same hook as the 4x Octopus Straight Eye, but without any offset. This makes a great trolling hook and will upgrade any trolling lures.

| SIZES | | 4/0 | 5/0 | 6/0 | 7/0 | 8/0 | 9/0 | 10/0 |
|----------|----|-----------|-----------|-----------|-----------|-----------|-----------|-----------|
| NS Black | LS | 263414(6) | 263415(6) | 263416(6) | 263417(6) | 263418(6) | 263419(5) | 263420(5) |

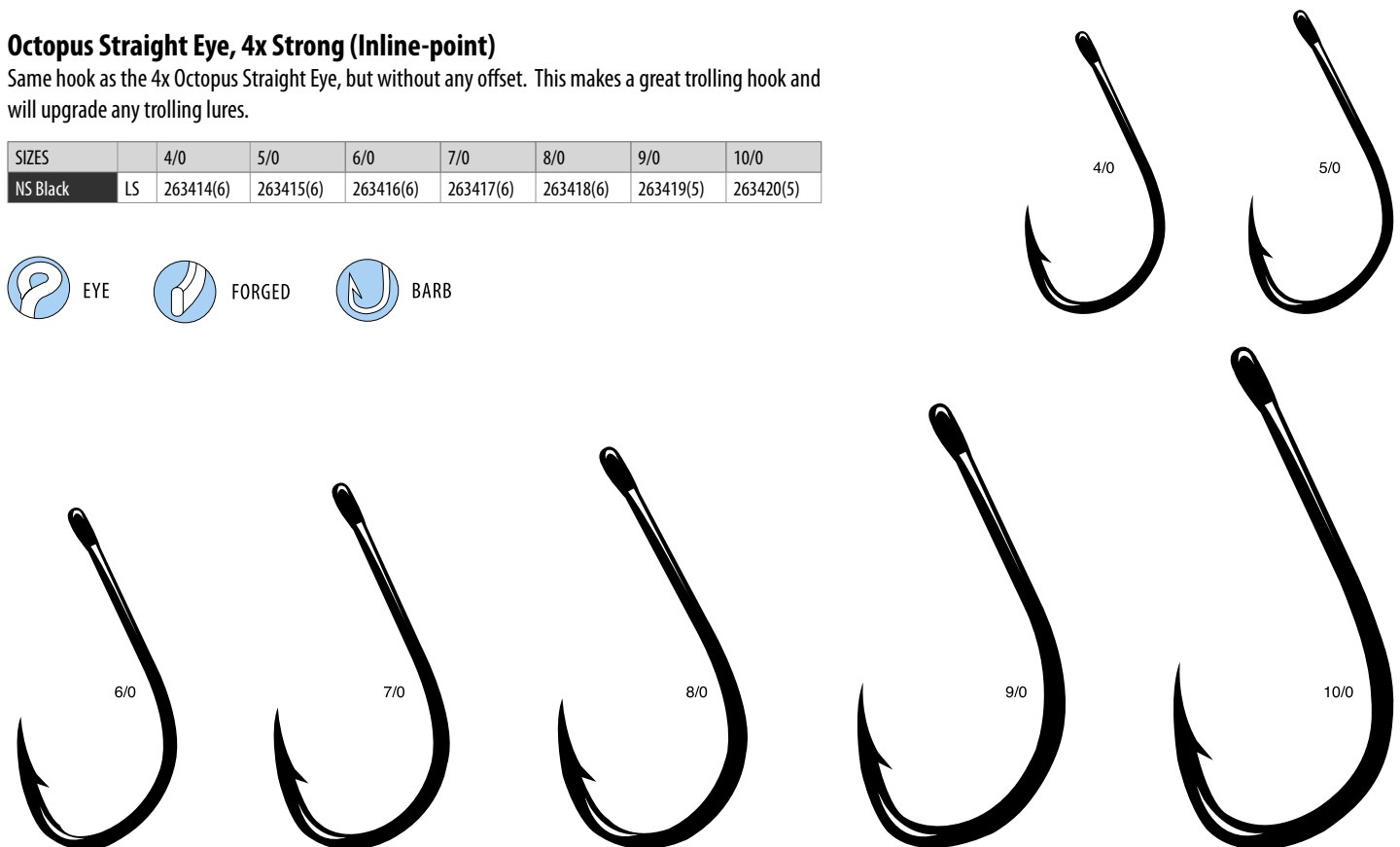

Octopus Circle (Offset-point)

Specially designed to set in the corner of the fish's mouth, making it a great choice for the fresh and saltwater fisherman still wanting to use bait.

| SIZES | | 8 | 6 | 4 | 2 | 1 | 1/0 | 2/0 | 3/0 | 4/0 | 5/0 | 6/0 | 7/0 | 8/0 |
|------------|-------|------------|------------|------------|-----------|-----------|-----------|-----------|-----------|-----------|-----------|-----------|-----------|-----------|
| NS Black | LS | 208406(10) | 208407(10) | 208408(10) | 208409(8) | 208410(8) | 208411(6) | 208412(6) | 208413(6) | 208414(6) | 208415(6) | 208416(6) | 208417(6) | 208418(6) |
| | 25 pk | 208406-25 | 208407-25 | 208408-25 | 208409-25 | 208410-25 | 208411-25 | 208412-25 | 208413-25 | 208414-25 | 208415-25 | 208416-25 | 208417-25 | 208418-25 |
| Nano Alpha | LS | | | 208208(10) | 208209(8) | 208210(8) | 208211(6) | 208212(6) | 208213(6) | 208214(6) | 208215(6) | 208216(6) | | |



Octopus Circle (Inline-point) **TOURNAMENT LEGAL**

Same design as the Octopus Circle, but without any offset with some Billfish tournament regulations and some fisheries that require non-offset circle hooks.

| SIZES | | 1/0 | 2/0 | 3/0 | 4/0 | 5/0 | 6/0 | 7/0 | 8/0 |
|----------|-------|-----------|-----------|-----------|-----------|-----------|-----------|-----------|-----------|
| NS Black | LS | 221411(6) | 221412(6) | 221413(6) | 221414(6) | 221415(6) | 221416(6) | 221417(6) | 221418(6) |
| | 25 pk | 221411-25 | 221412-25 | 221413-25 | 221414-25 | 221415-25 | 221416-25 | 221417-25 | 221418-25 |
| Red | LS | 221311(6) | 221312(6) | 221313(6) | 221314(6) | 221315(6) | 221316(5) | 221317(5) | 221318(4) |

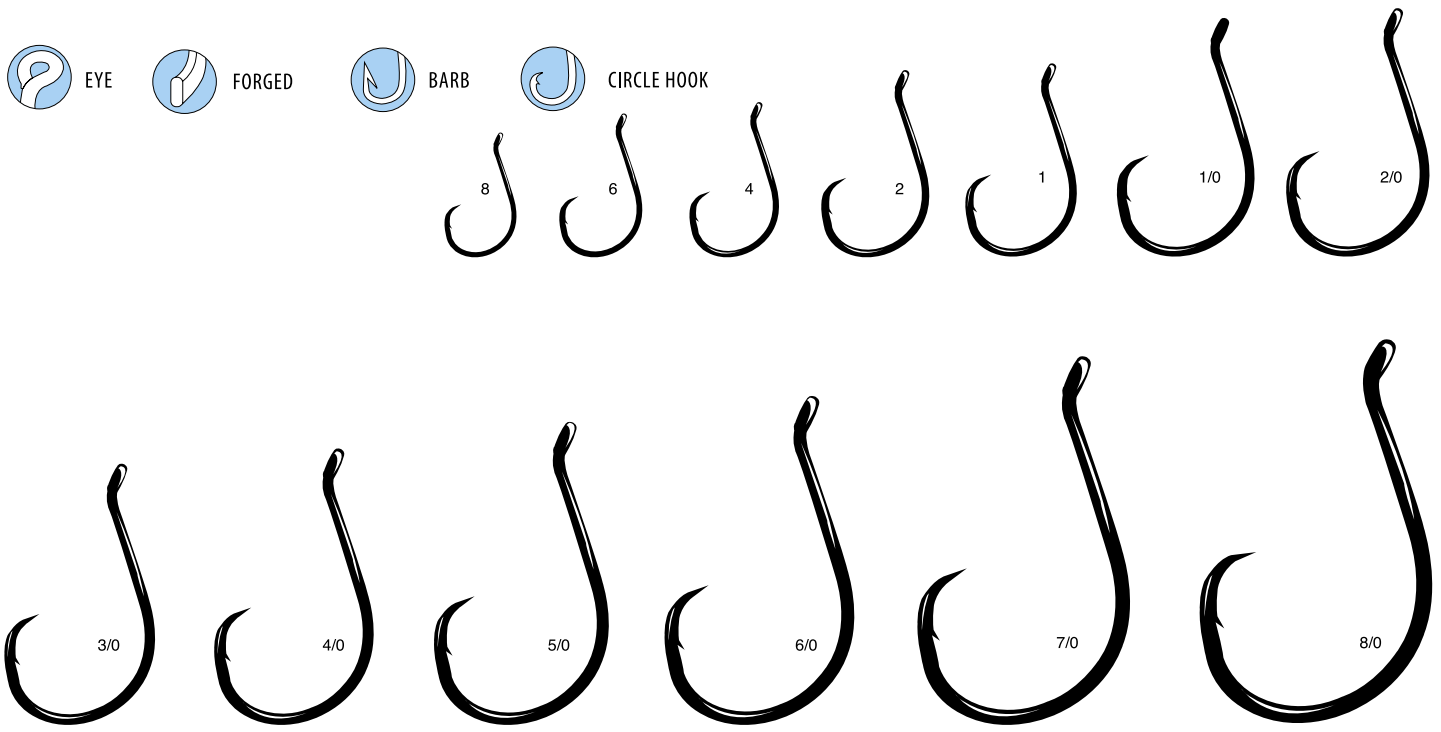

Octopus Circle (Inline-point) Barbless **TOURNAMENT LEGAL**

| SIZES | | 3/0 | 4/0 | 5/0 |
|----------|----|-----------|-----------|-----------|
| NS Black | LS | 224413(6) | 224414(6) | 224415(6) |



Octopus Circle Out Barb, 1x Strong

Will Gamakatsu's Octopus Circle "Outbarb" 1x Strong hook change angling forever? There's a strong possibility, and for good reason. Traditional hooks place the barb on the inside of the hook bend. With certain techniques, like jigging, chunk baiting, and bottom fishing, if your line becomes limp or goes slack it could get entangled by the hook barb and possibly be nicked or cut. The outbarb design eliminates that risk. But there's more. Tests have proven that when an outbarb is combined with Gamakatsu's circle hook design, it results in deeper penetration and a higher hook retention rate. Think about it: a barb on the inner side of a hook bend is somewhat protected. A barb on the outside of the hook bend will come into contact with whatever flesh it touches and prevent movement in the opposite direction from which it entered. Consistently, Gamakatsu researchers and prostaffers documented increased retention of hooked species.

| SIZES | | 3/0 | 4/0 | 5/0 | 6/0 | 7/0 | 8/0 | 10/0 | 12/0 |
|----------|----|-----------|-----------|-----------|-----------|-----------|-----------|-----------|-----------|
| NS Black | LS | 363413(6) | 363414(6) | 363415(6) | 363416(6) | 363417(5) | 363418(5) | 363420(3) | 363422(3) |



EYE



FORGED



OUT-BARB



CIRCLE HOOK



OFF-SET POINT

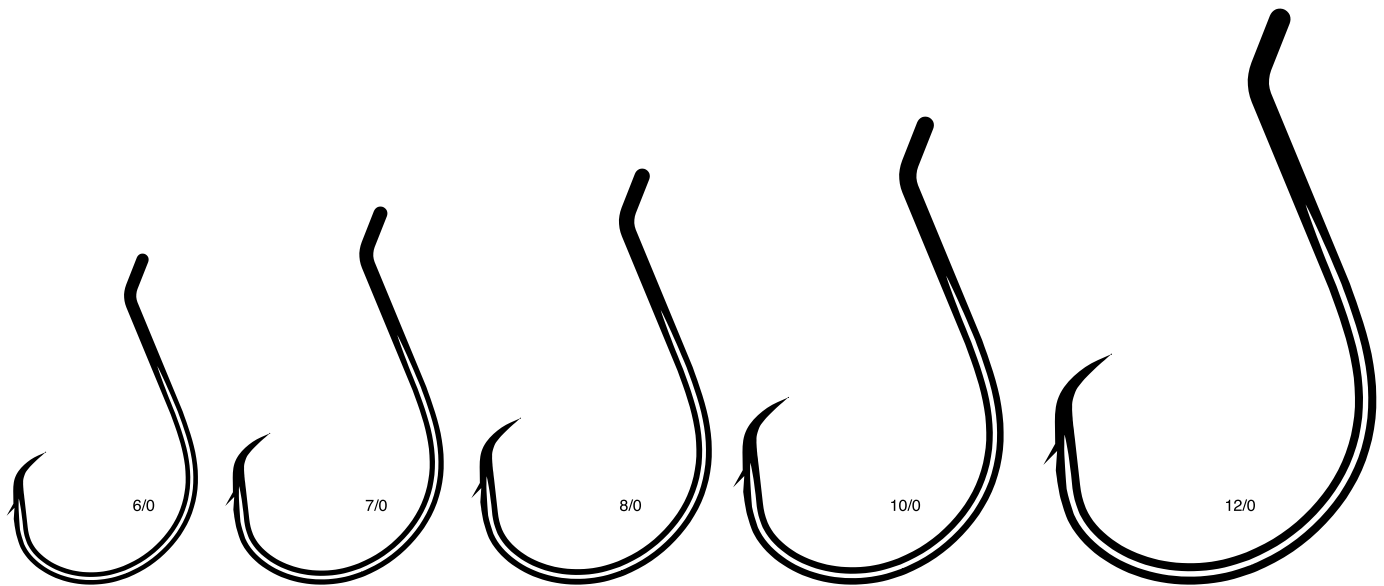
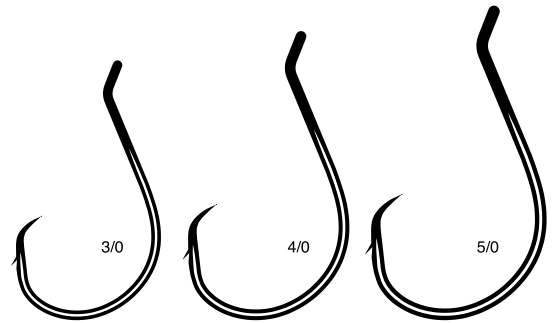

Octopus Circle Straight Eye (Inline-point) TOURNAMENT LEGAL

| SIZES | | 1 | 1/0 | 2/0 | 3/0 | 4/0 | 5/0 | 6/0 | 7/0 | 8/0 |
|------------|--------|-----------|-----------|-----------|------------|------------|------------|------------|-----------|-----------|
| NS Black | LS | 265410(8) | 265411(6) | 265412(6) | 265413(6) | 265414(6) | 265415(6) | 265416(6) | 265417(6) | 265418(6) |
| | 25 pk | 265410-25 | 265411-25 | 265412-25 | 265413-25 | 265414-25 | 265415-25 | 265416-25 | 265417-25 | 265418-25 |
| | 100 pk | | | | 265413-100 | 265414-100 | 265415-100 | 265416-100 | | |
| Nano Alpha | LS | | 265211(6) | 265212(6) | 265213(6) | 265214(6) | 265215(6) | | | |

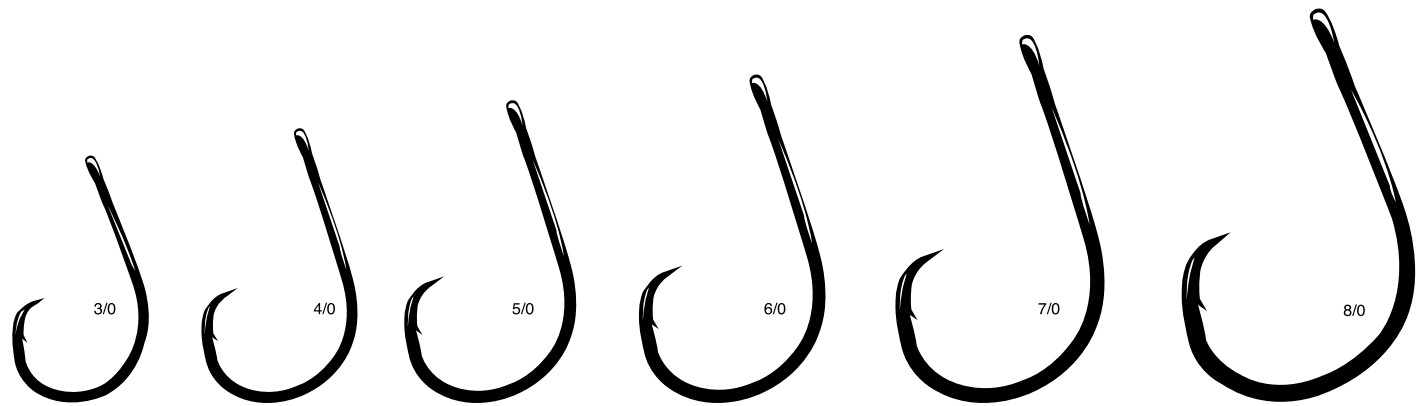
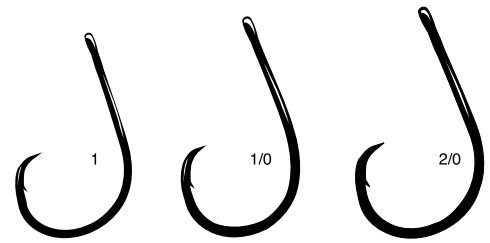

Octopus Circle 4x Strong, Straight Eye (Offset-point)

This hook is designed for heavier lines and bigger fish. The offset point makes it a good choice for many chunk bait situations.

| SIZES | | 1/0 | 2/0 | 3/0 | 4/0 | 5/0 | 6/0 | 7/0 | 8/0 |
|------------|----|-----------|-----------|-----------|-----------|-----------|-----------|-----------|-----------|
| NS Black | LS | 209411(6) | 209412(6) | 209413(6) | 209414(6) | 209415(6) | 209416(6) | 209417(6) | 209418(6) |
| | 25 | | | | | 209415-25 | 209416-25 | 209417-25 | 209418-25 |
| Nano Alpha | LS | 209211(6) | 209212(6) | 209213(6) | 209214(6) | 209215(6) | | | |

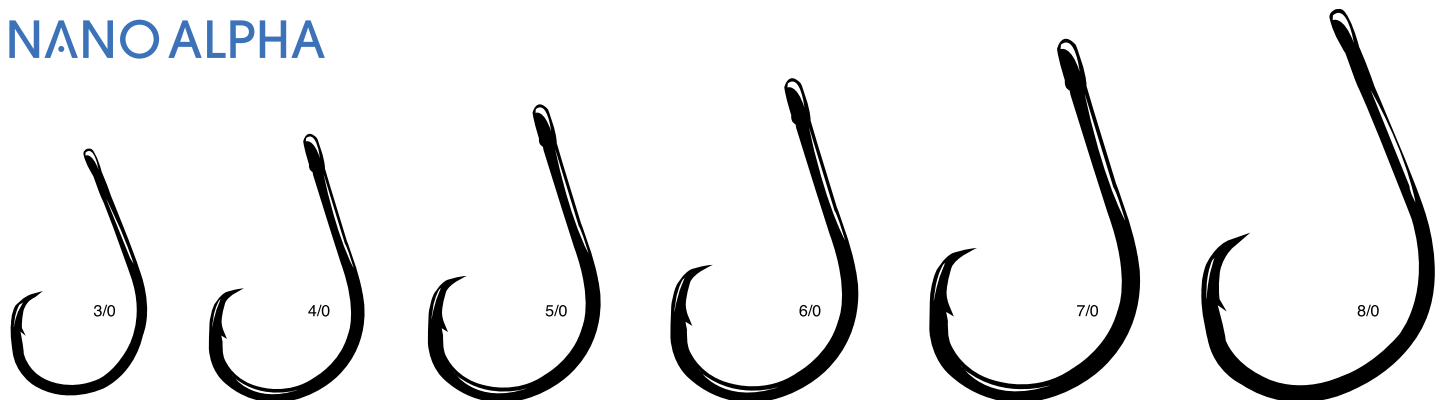
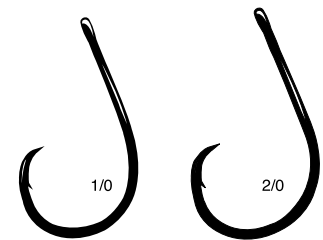

Octopus Circle 4x Strong, Straight Eye (Inline-point), **TOURNAMENT LEGAL**

To comply with new angling regulations in the Gulf of Mexico, we've redesigned and reinforced our most popular circle hook. The 4X Strong Circle Hook is built for the toughest battles in the deep sea. The straight eye, NS Black finish and inline point (not offset) complies with the new rules, but doesn't reduce the hook's effectiveness. This is the new "go-to" hook charter captains and professional anglers are using for deep dropping and reef and wreck fishing. Heavy up your rods, reels and line, because the 4X Strong Circle Hook will never give up when it comes to pulling snapper and monster grouper out of their fortified hangouts.

| SIZES | | 1/0 | 2/0 | 3/0 | 4/0 | 5/0 | 6/0 | 7/0 | 8/0 | 9/0 |
|------------|----|-----------|-----------|-----------|-----------|-----------|-----------|-----------|-----------|-----------|
| NS Black | LS | 360411(6) | 360412(6) | 360413(6) | 360414(6) | 360415(6) | 360416(6) | 360417(6) | 360418(6) | 360419(5) |
| Nano Alpha | LS | | | | 360214(6) | 360215(6) | 360216(6) | 360217(6) | 360218(6) | 360219(5) |

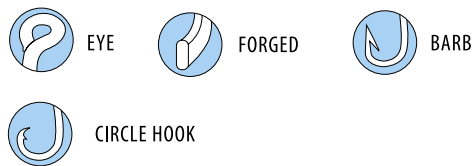

NANO ALPHA

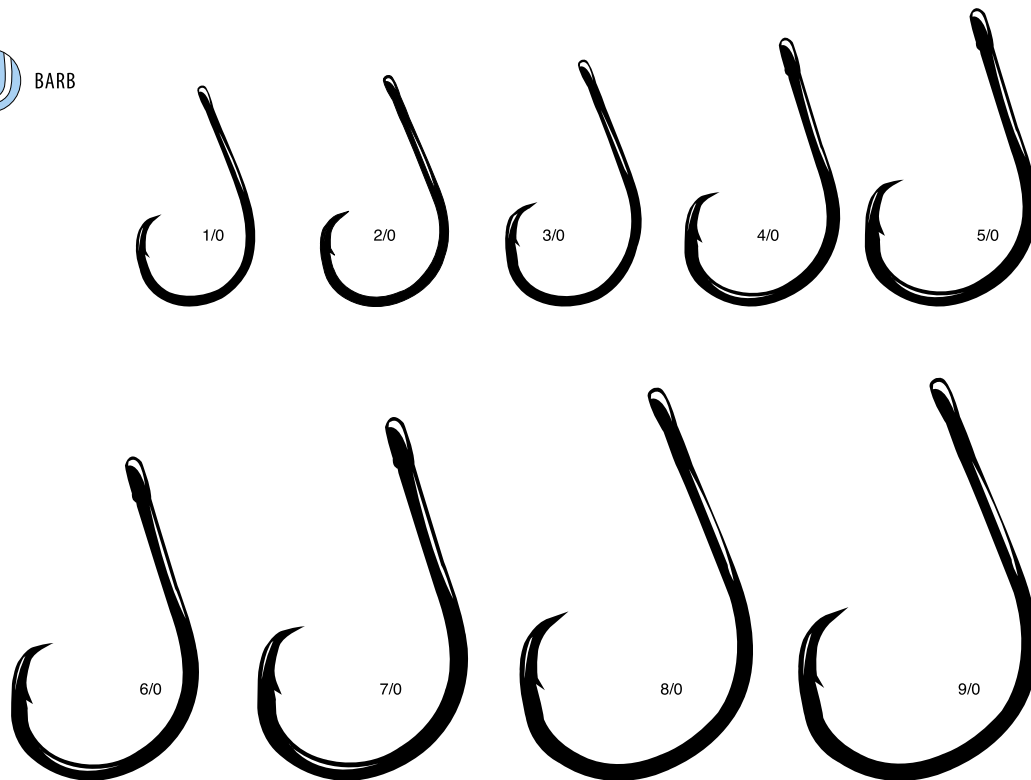

Crankbait Circle

Bill Dance designed Crankbait Circle is a new concept in crankbait hooks which allows an angler to easily fish a plug in and around cover with less chance of hanging up. Incorporating the circle hook design increases an anglers hook to land ratio significantly, versus a standard treble style hook that is typically used on crankbaits. Adding the Magic Eye feature to this innovative new design allows you to quickly change hooks on your baits, due to the tapered eye design. Legendary angler Bill Dance is excited about the new possibilities the Crankbait Circle presents, including the ability to probe untapped waters that crankbaits often cannot reach.

"I believe using crankbaits in heavy cover is an untapped angling opportunity for several species. Treble hooks on crankbaits around cover can create a lot of snags and I wanted a hooking system that would reduce snags when using this type of lure. I designed this hook specifically for crankbaits in heavy cover and I have been thrilled with how well it works,"
 ~ Bill Dance.

| SIZES | | 4 | 2 | 1 | 1/0 | 2/0 | 3/0 |
|----------|----|-----------|-----------|-----------|-----------|-----------|-----------|
| NS Black | LS | 463408(6) | 463409(6) | 463410(6) | 463411(6) | 463412(6) | 463413(6) |

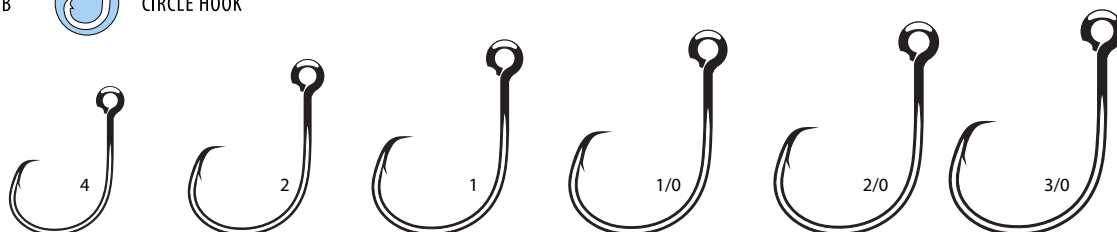

Big River Bait

The Big River Bait hook is forged for extra strength with an up eye for easy snelling. The large gap allows for quick penetration and the unique bend offers great holding power. The NS Black finish is durable and corrosion resistant.

| SIZES | | 4 | 2 | 1 | 1/0 | 2/0 | 3/0 | 4/0 | 5/0 | 6/0 | 7/0 | 8/0 | 9/0 | 10/0 | 12/0 |
|----------|-------|------------|-----------|-----------|-----------|-----------|-----------|-----------|-----------|-----------|-----------|-----------|-----------|-----------|-----------|
| NS Black | LS | 225408(10) | 225409(8) | 225410(8) | 225411(6) | 225412(6) | 225413(6) | 225414(6) | 225415(6) | 225416(6) | 225417(6) | 225418(5) | 225419(4) | 225420(3) | 225422(3) |
| | 25 pk | 225408-25 | 225409-25 | 225410-25 | 225411-25 | 225412-25 | 225413-25 | 225414-25 | 225415-25 | 225416-25 | 225417-25 | 225418-25 | | | |
| Red | LS | | | 225310(8) | 225311(6) | 225312(6) | 225313(6) | 225314(6) | 225315(6) | 225316(6) | | | | | |
| | 25 pk | | | 225310-25 | 225311-25 | 225312-25 | 225313-25 | 225314-25 | 225315-25 | 225316-25 | | | | | |

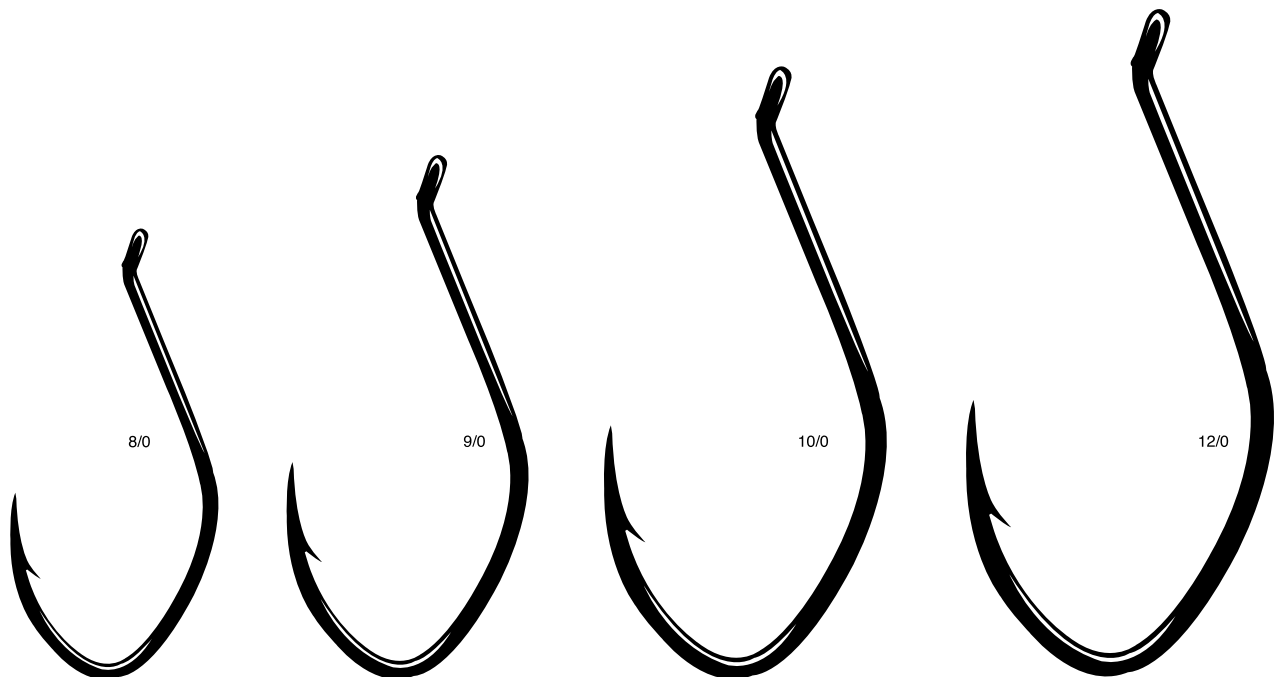
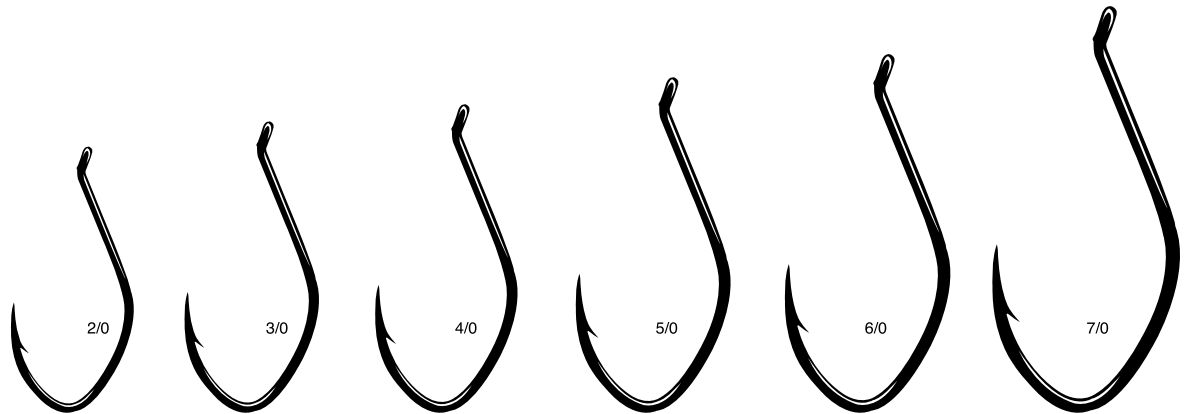
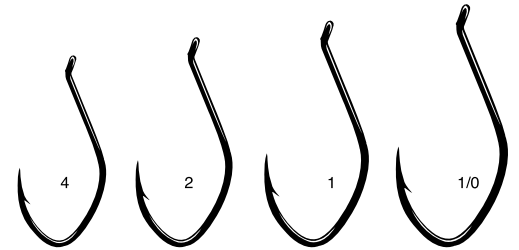
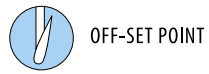

Big River Bait Barbless

The innovative design has overtaken bait fisheries from coast to coast. Now the Big River Bait Hook is available as barbless to comply with conservation initiatives and new regulations. No need to pinch the barb on these forged shank hooks. The large gap and unique shape enable instant penetration and holding power. Corrosion resistant and available in all popular sizes.

| SIZES | | 5/0 | 6/0 | 7/0 |
|----------|-------|-----------|-----------|-----------|
| NS Black | LS | 376415(6) | 376416(6) | 376417(6) |
| | 25 pk | 376415-25 | 376416-25 | 376417-25 |

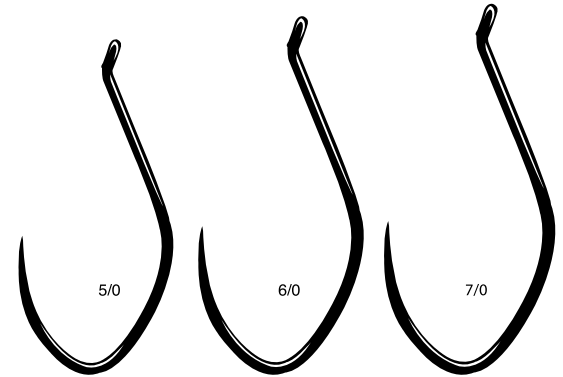
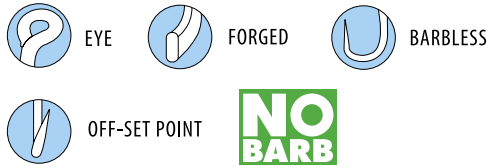

Big River Bait Open Eye

The reception to our Big River Bait Hook has been so strong that angler's immediately began asking for a siwash-style hook they could use on their spinners, spoons and plugs for salmon. The answer... this fast penetrating hook holds better than conventional hook designs. When fished barbless (which requires pinching the barb down) it's the best barbless hook you'll find. The unique Big River hook design locks fish in place when hooked. Forged for exceptional strength and built Gamakatsu sharp the Big River Open Eye is sure to make great lures even better.

| SIZES | | 1/0 | 2/0 | 3/0 | 4/0 | 5/0 | 6/0 | 7/0 |
|----------|----|-----------|-----------|-----------|-----------|-----------|-----------|-----------|
| NS Black | LS | 225911(5) | 225912(5) | 225913(5) | 225914(5) | 225915(5) | 225916(5) | 225917(4) |
| | 25 | 225911-25 | 225912-25 | 225913-25 | 225914-25 | 225915-25 | 225916-25 | |

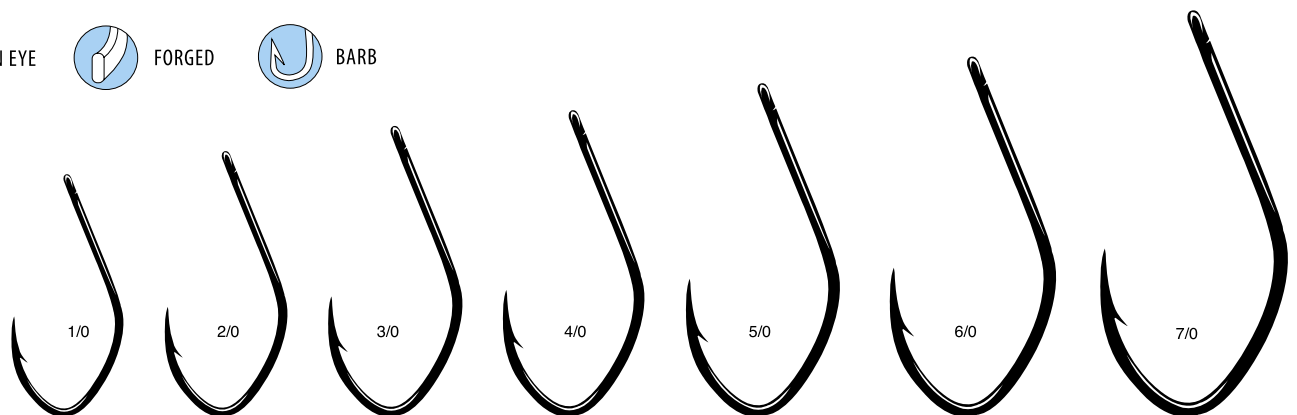

Baitholder Hooks (See page 132 for snells.)

The ever popular baitholder hook is used for a variety of fish and comes in either a Bronze finish or a corrosion resistant NS Black finish for use in saltwater. It also comes in a handy snell pack.

| SIZES | 14 | 12 | 10 | 8 | 6 | 4 | 2 | 1 | 1/0 | 2/0 | 3/0 | 4/0 | 5/0 | 6/0 |
|-----------------|-----|-----------|-----------|-----------|-----------|-----------|-----------|-----------|----------|----------|----------|----------|----------|----------|
| Bronze | LS | 05104(10) | 05105(10) | 05106(10) | 05107(10) | 05108(10) | 05109(8) | 05110(8) | | | | | | |
| | 100 | 05104-100 | 05105-100 | 05106-100 | 05107-100 | 05108-100 | 05109-100 | 05110-100 | | | | | | |
| | SNL | 05603(10) | 05604(10) | 05605(10) | 05606(10) | 05607(10) | 05608(10) | 05609(8) | | | | | | |
| NS Black | LS | | | | | | 05409(8) | 05410(8) | 05411(7) | 05412(7) | 05413(6) | 05414(6) | 05415(5) | 05416(5) |
| | 25 | | | | | | 05409-25 | 05410-25 | 05411-25 | 05412-25 | 05413-25 | 05414-25 | 05415-25 | 05416-25 |

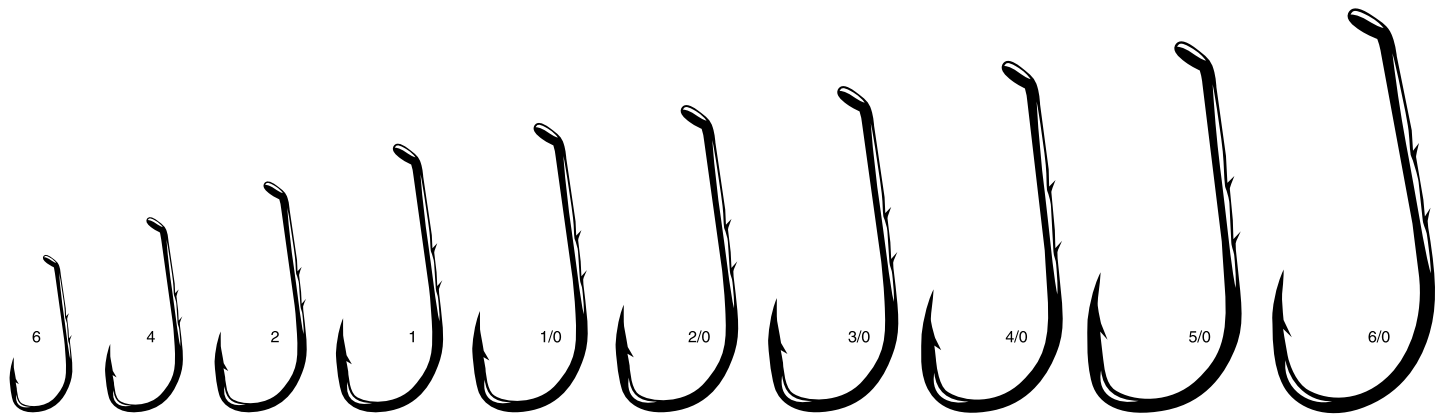
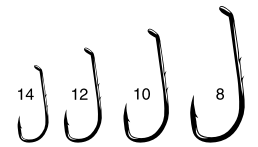
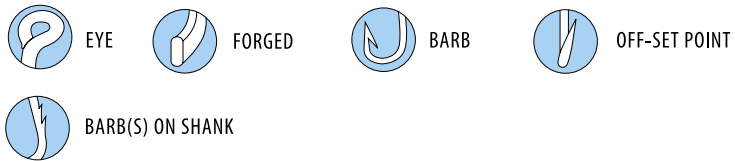

Siwash Open Eye

A must have replacement hook for your favorite spinner, spoon, or plug. The open eye makes for fast and easy attachment.

| SIZES | | 10 | 8 | 6 | 4 | 2 | 1 | 1/0 | 2/0 | 3/0 | 4/0 | 5/0 | 6/0 |
|----------|------|-----------|-----------|-----------|-----------|-----------|-----------|-----------|-----------|-----------|----------|----------|----------|
| Nickel | LS | 10005(10) | 10006(10) | 10007(10) | 10008(10) | 10009(8) | 10010(8) | 10011(6) | 10012(6) | 10013(6) | 10014(6) | 10015(6) | 10016(5) |
| | 25 | | | | | | | 10011-25 | 10012-25 | 10013-25 | 10014-25 | 10015-25 | 10016-25 |
| | Bulk | 10005-100 | 10006-100 | 10007-100 | 10008-100 | 10009-100 | 10010-100 | 10011-100 | 10012-100 | 10013-100 | 10014-50 | 10015-50 | |
| Red | LS | | | | | | | 10311(6) | 10312(6) | 10313(6) | 10314(6) | 10315(6) | |
| NS Black | LS | | 10406(10) | 10407(10) | 10408(10) | 10409(8) | 10410(8) | 10411(6) | 10412(6) | 10413(6) | 10414(5) | 10415(4) | |



OPEN EYE



BARB

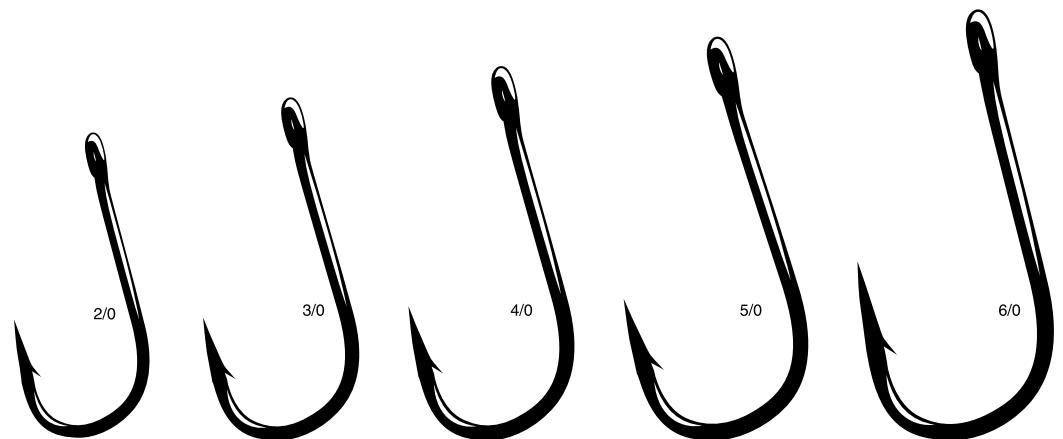
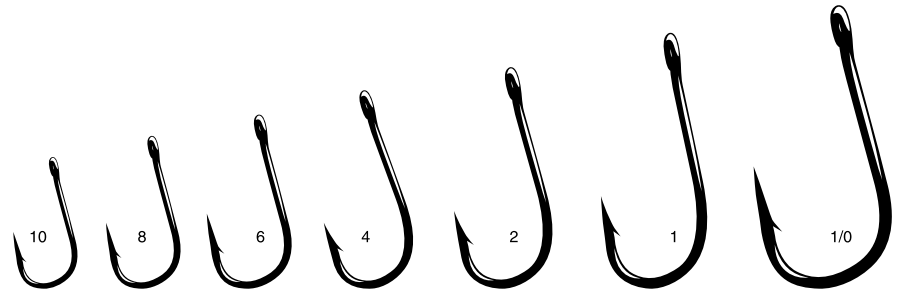



Gamakatsu

Gamakatsu



**FRESHWATER
HOOKS**

Spalkakatsu®

Spin Bait

Walleye anglers across the Midwest have become dependent upon the spin style hooks for walleye rigs. The Spin Bait hook can be rigged behind spinner blades, prop blades or used alone with just a simple bead in front of them. It's unique design incorporates Gamakatsu swivels that is independent of the hook, giving the hook more freedom to spin while reducing line twist. The Spin Bait hook features Nano Smooth Coat for stealth presentations and unsurpassed hook penetration and the bait keeper barbs on the shank hold live and plastic baits on more securely.

| SIZES | | 4 | 2 | 1 | 1/0 |
|------------------|----|-----------|-----------|-----------|-----------|
| Nano Smooth Coat | LS | 389208(4) | 389209(4) | 389210(4) | 389211(4) |

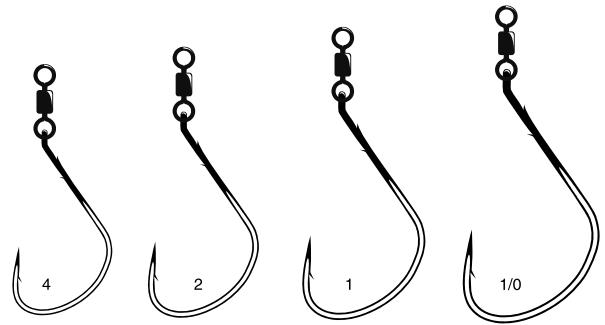
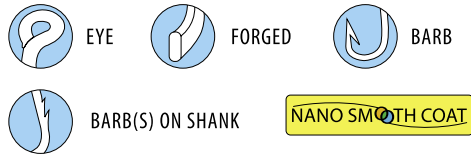

TW Hook

The TW stands for "Trout Worm" and is the perfect hook for those soft plastic finesse worms that require a delicate presentation. It has the right gap to accommodate the worm and hold the fish.

| SIZES | | 16 | 14 | 12 | 10 | 8 | 6 |
|--------|----|------------|------------|------------|------------|------------|------------|
| Bronze | LS | 262102(10) | 262103(10) | 262104(10) | 262105(10) | 262106(10) | 262107(10) |

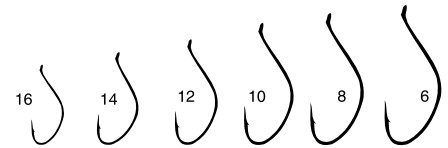

Single Egg Hooks, Barb On Shank *(See page 132 for snells.)*

A premier bait hook for single eggs. Also great for floating trout bait.

| SIZES | | 14 | 12 | 10 | 8 | 6 |
|-------|-----|-----------|-----------|-----------|-----------|-----------|
| Red | LS | 04303(10) | 04304(10) | 04305(10) | 04306(10) | 04307(10) |
| | SNL | 04803(10) | 04804(10) | 04805(10) | 04806(10) | 04807(10) |
| Gold | LS | 04203(10) | 04204(10) | 04205(10) | 04206(10) | 04207(10) |
| | SNL | | 04704(10) | 04705(10) | 04706(10) | 04707(10) |



Aberdeen

Designed with a long shank, as a light wire bait hook.

| SIZES | | 6 | 4 | 2 |
|--------|----|-----------|-----------|----------|
| Bronze | LS | 09107(10) | 09108(10) | 09109(8) |

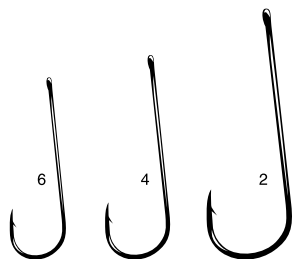

Crappie Assortment

3 hooks per color, 15 hooks total

| SIZES | | 8 | 6 | 4 | 2 |
|----------|----|-------|-------|-------|-------|
| 5 COLORS | LS | 02606 | 02607 | 02608 | 02609 |

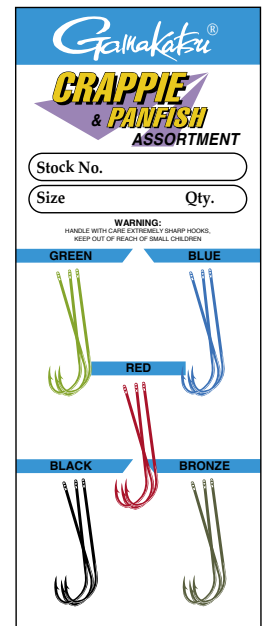

Single Hook 52

The Single Hook 52 features an oversized eye engineered to fit split rings when replacing existing treble or single hooks. Ideal as a replacement hook for smaller spoons, the enlarged eye allows greater movement on the split ring, reducing leverage and minimizing lost fish during the fight.

| SIZES | | 12 | 10 | 8 | 6 | 4 | 2 | 1 | 1/0 | 2/0 |
|----------|----|------------|------------|------------|------------|------------|------------|------------|------------|------------|
| NS Black | LS | 487404 (8) | 487405 (8) | 487406 (8) | 487407 (8) | 487408 (8) | 487409 (8) | 487410 (8) | 487411 (7) | 487412 (7) |



NEW

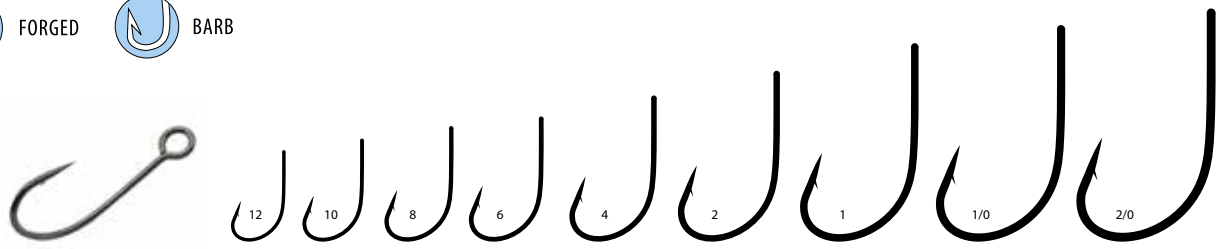

Single Hook 53

Designed specifically for smaller plug applications, the Single Hook 53 incorporates a large inline eye that fits over split rings while maintaining proper lure alignment. The inline eye design reduces snags and improves hookup efficiency, offering a refined alternative to traditional treble setups.

| SIZES | | 12 | 10 | 8 | 6 | 4 | 2 | 1 |
|----------|----|------------|------------|------------|------------|------------|------------|------------|
| NS Black | LS | 488404 (8) | 488405 (8) | 488406 (8) | 488407 (8) | 488408 (8) | 488409 (8) | 488410 (8) |



NEW

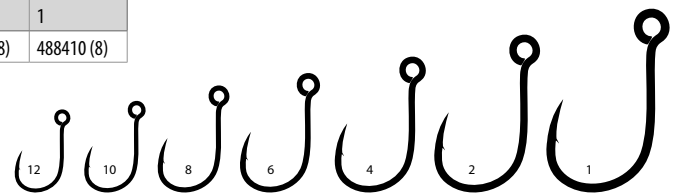

Walleye Wide Gap

In-line needle point design won't roll or twist when trolled. Light weight for live bait presentations. Forged for extra strength.

| SIZES | | 8 | 6 | 4 | 2 | 1 |
|----------|----|------------|------------|------------|-----------|-----------|
| NS Black | LS | 202406(10) | 202407(10) | 202408(10) | 202409(8) | 202410(8) |
| | 25 | 202406-25 | 202407-25 | 202408-25 | 202409-25 | 202410-25 |

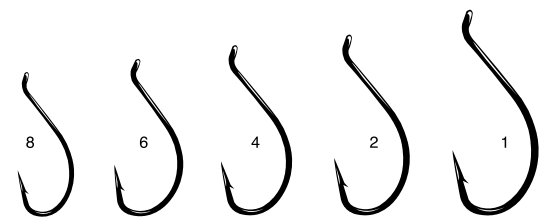

Shiner Straight Eye

Great hook for live shiners, crawdads, and shrimp. This style is also very popular for many different types of Catfish baits.

| SIZES | | 6 | 4 | 2 | 1 | 1/0 | 2/0 | 3/0 | 4/0 | 5/0 |
|----------|----|----------|----------|----------|----------|----------|----------|----------|----------|----------|
| NS Black | LS | 51407(8) | 51408(7) | 51409(7) | 51410(6) | 51411(6) | 51412(6) | 51413(5) | 51414(4) | 51415(4) |
| NS Black | 25 | | 51408-25 | 51409-25 | 51410-25 | 51411-25 | 51412-25 | 51413-25 | 51414-25 | |

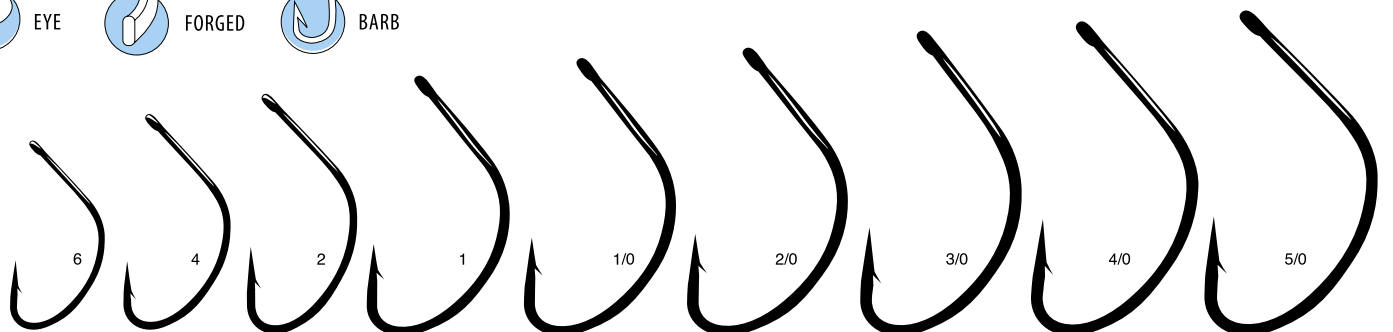

Shiner Upturned Eye

Same great shape, only with an upturned eye, makes it great for snelling.

| SIZES | | 1/0 | 2/0 | 3/0 | 4/0 |
|----------|----|----------|----------|----------|----------|
| NS Black | LS | 52411(6) | 52412(6) | 52413(5) | 52414(4) |
| | 25 | 52411-25 | 52412-25 | 52413-25 | 52414-25 |

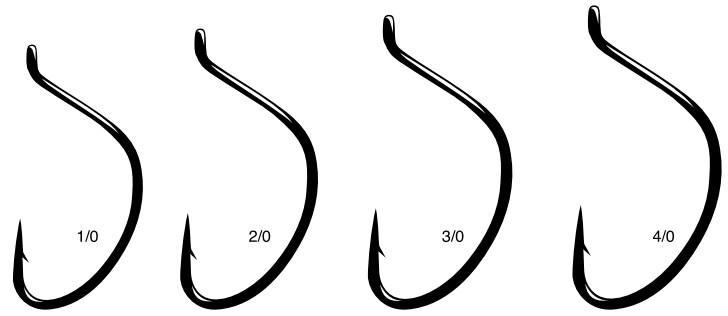

Ball Rig Hook

Purpose-built for today's popular urchin-style finesse baits, the Gamakatsu Ball Rig Hook delivers the ideal balance of natural presentation and reliable hook-up performance. Its wide gap design perfectly accommodates bulky soft plastics, while Tournament Grade Wire (TGW) construction and Nano Alpha technology provide exceptional sharpness, strength, smoother penetration, and corrosion resistance. An innovative Weight Clip system allows anglers to quickly adjust weight sizes without retying, making it easy to fine-tune presentation and fall rate for changing conditions.

| SIZES | | 1 | 1/0 | 2/0 | 3/0 | 4/0 | 5/0 |
|------------|----|------------|------------|------------|------------|-----------|------------|
| NANO ALPHA | LS | 490210 (3) | 490211 (3) | 490212 (3) | 490213 (3) | 490214(3) | 490215 (3) |

NANO ALPHA **NEW**

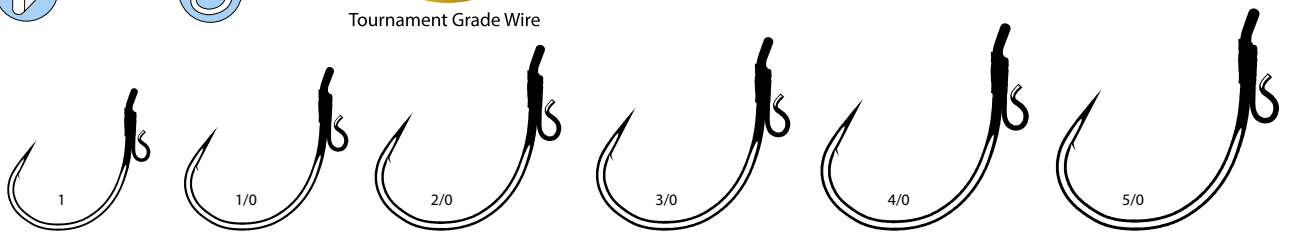

Ball Rig Hook Weedless

Built for fishing urchin-style finesse baits in heavy cover, the Gamakatsu Ball Rig Hook Weedless combines a wide gap design with a premium titanium weedguard for excellent snag resistance without sacrificing hook-up performance. Constructed from Tournament Grade Wire (TGW) and enhanced with Nano Alpha technology, it delivers superior sharpness, strength, smooth penetration, and corrosion resistance. The integrated Weight Clip system allows for fast weight adjustments, giving anglers precise control over bait action and presentation.

| SIZES | | 1 | 1/0 | 2/0 | 3/0 | 4/0 | 5/0 |
|------------|----|------------|------------|------------|------------|------------|------------|
| NANO ALPHA | LS | 491210 (3) | 491211 (3) | 491212 (3) | 491213 (3) | 491214 (3) | 491215 (3) |

NANO ALPHA **NEW**

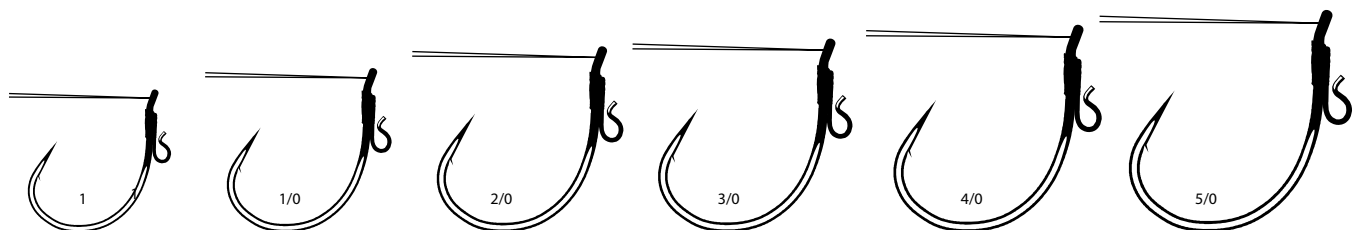

Wicked Wacky

The new standard in wacky hook designs. Built on Gamakatsu proven Shiner hook, the Wicked Wacky features a durable hand tied weed guard that provides anglers the confidence to throw their wacky rig in and around heavy cover. In addition the Wicked Wacky takes the power drop shot to a new level. Gamakatsu designed an innovative hollow tube, hand tied on the shank. Simply run the tag end of your line through the tube, tie on your weight, and pitch into the heaviest cover for a whole new power drop shot presentation.

| SIZES | | 1/0 | 2/0 | 3/0 | 4/0 | 5/0 |
|----------|----|-----------|-----------|-----------|-----------|-----------|
| NS Black | LS | 306411(3) | 306412(3) | 306413(3) | 306414(3) | 306415(3) |

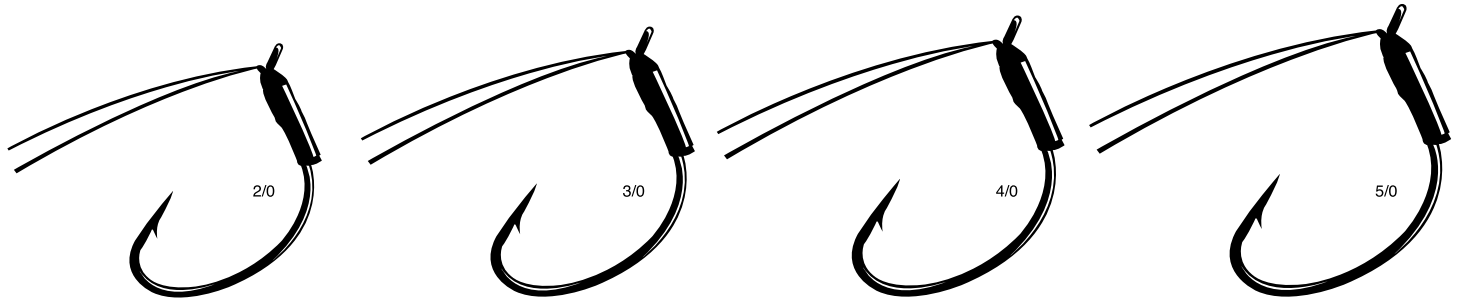
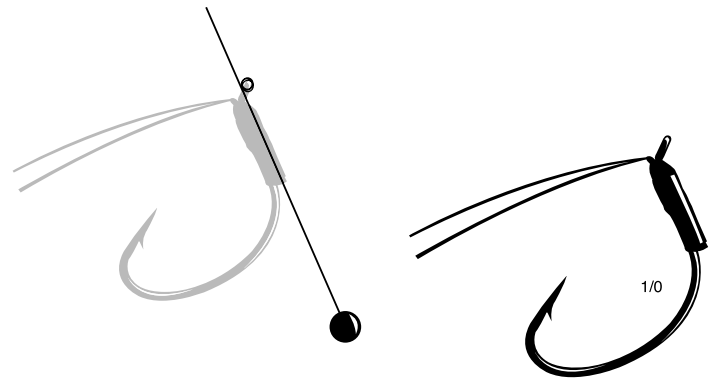

Antenna Hook

Engineered for precision and finesse, the Antenna Hook is built with Tournament Grade Wire (TGW), Nano Smooth Coat, and the premium series G-Finesse stinger hook design. The adjustable 90-degree fluorocarbon weed guard provides an extremely high ability to avoid snags. The Antenna Hook offers versatile protection and promotes “Shokkaku”—the Japanese concept of heightened perception or sense of touch. The fluorocarbon loop keeper provides excellent plastic retention, making this hook perfect for bottom search baits.

| SIZES | | 6 | 4 | 2 | 1 |
|------------------|----|-----------|-----------|-----------|-----------|
| Nano Smooth Coat | LS | 481207(4) | 481208(4) | 481209(4) | 481210(4) |

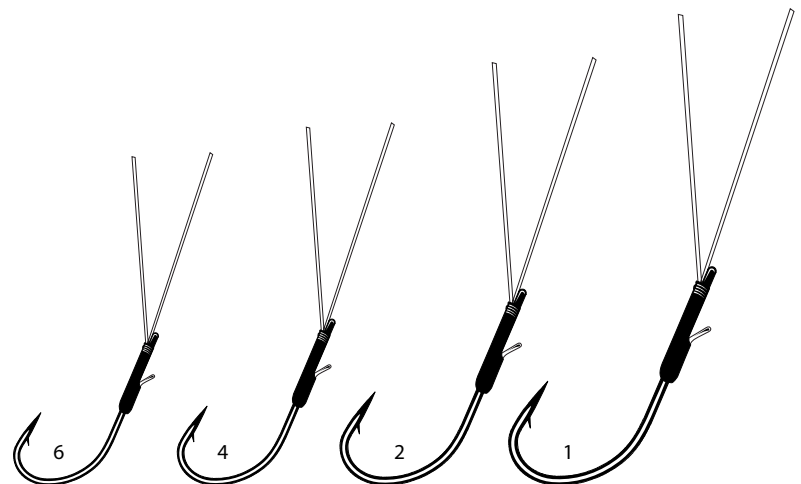
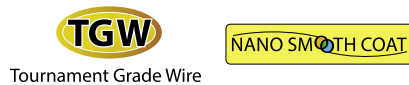

Split Shot/Drop Shot

The ultimate hook for nose hooking a Roboworm, small Gitzit, or any number of soft plastic drop shot baits. When it's time to get serious about finesse fishing this hook will amaze you.

| SIZES | | 4 | 2 | 1 | 1/0 | 2/0 | 3/0 |
|--------------------|----|-------------|-------------|-------------|----------|----------|----------|
| NS Black | LS | 50408(6) | 50409(6) | 50410(6) | 50411(6) | 50412(6) | 50413(6) |
| | 2S | 50408-2S | 50409-2S | 50410-2S | 50411-2S | 50412-2S | 50413-2S |
| Red | LS | 50308(6) | 50309(6) | 50310(6) | 50311(6) | | |
| | 2S | 50308-2S | 50309-2S | 50310-2S | 50311-2S | | |
| Flourescent Pink | LS | 50608-P(6) | 50609-P(6) | 50610-P(6) | | | |
| Flourescent Orange | LS | 50608-OR(6) | 50609-OR(6) | 50610-OR(6) | | | |
| Chartreuse | LS | 50608-C(6) | 50609-C(6) | 50610-C(6) | | | |
| Flourescent Red | LS | 50608-FR(6) | 50609-FR(6) | 50610-FR(6) | | | |

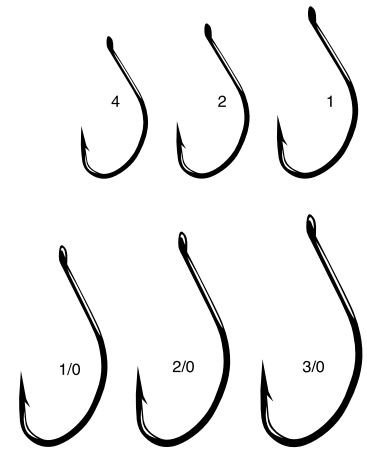

Split Shot/Drop Shot Weedless

Gamakatsu has done it... again! Another fishing hook first with the introduction of the new Weedless Split Shot/Drop Shot Hook. The wide gap hook design is paired to a hair-trigger hand-tied, weed-guard for instant hook-ups. The weed guard maintains its shape and consistency fish-after-fish and is ultra-effective in staying weedless with exposed hook riggings.

| SIZES | | 4 | 2 | 1 | 1/0 | 2/0 | 3/0 |
|----------|----|----------|----------|----------|----------|----------|----------|
| NS Black | LS | 50908(5) | 50909(5) | 50910(5) | 50911(5) | 50912(5) | 50913(4) |

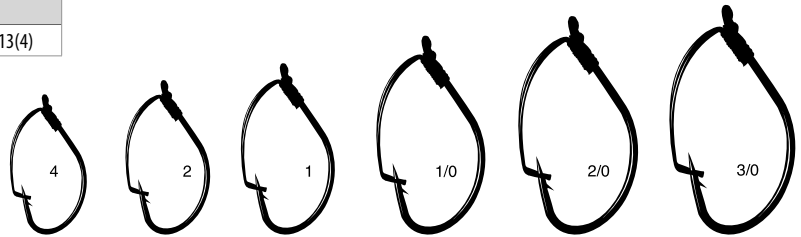

Super Tuned Drop Shot

The Super Tuned Drop Shot hook is designed for exceptional performance with a focus on precision and hookup ratios. Featuring Tournament Grade Wire (TGW) and Nano Alpha finish, this hook boasts a G-Lock point with a slightly upturned design to maximize hookup percentages. Its straight shank design ensures the hook rigs straight and stands out more prominently on the fishing line, enhancing presentation. Add this awesome new dropshot hook to your arsenal.

| SIZES | | 2 | 1 | 1/0 | 2/0 |
|------------|----|-----------|-----------|-----------|-----------|
| Nano Alpha | LS | 472209(6) | 472210(6) | 472211(6) | 472212(6) |

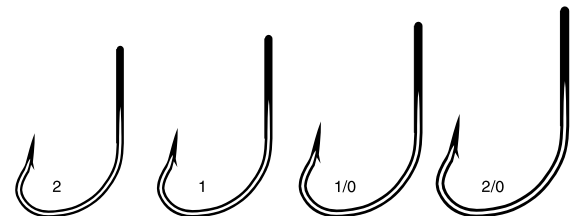

Tournament Grade Wire

NANO ALPHA

Finesse Wide Gap

The perfect hook for wacky rigging for bass, also great for free drifting for salmon and steelhead with small baits.

| SIZES | | 4 | 2 | 1 | 1/0 | 2/0 | 3/0 | 4/0 | 5/0 |
|----------|-------|-----------|-----------|-----------|-----------|-----------|-----------|-----------|-----------|
| NS Black | LS | 230408(6) | 230409(6) | 230410(6) | 230411(6) | 230412(6) | 230413(5) | 230414(5) | 230415(5) |
| | 25 pk | 230408-25 | 230409-25 | 230410-25 | 230411-25 | 230412-25 | 230413-25 | 230414-25 | 230415-25 |
| Red | LS | 230308(6) | 230309(6) | 230310(6) | 230311(6) | 230312(6) | 230313(5) | 230314(5) | |
| | 25 pk | 230308-25 | 230309-25 | 230310-25 | 230311-25 | 230312-25 | 230313-25 | 230314-25 | |

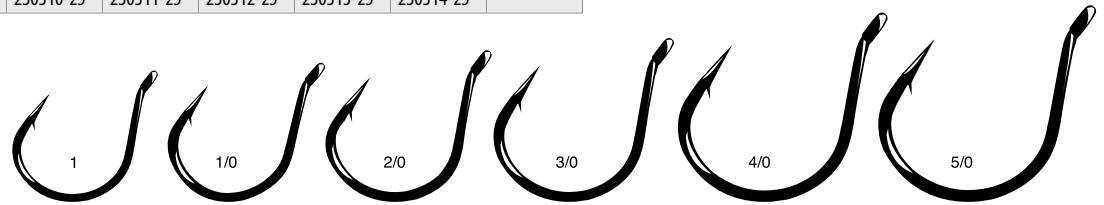
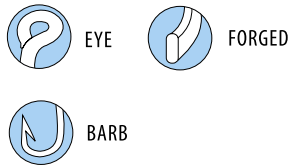

Finesse Wide Gap Weedless

Featuring an innovative nylon weed guard, allowing you to pitch your wacky rig into the heaviest cover.

| SIZES | | 4 | 2 | 1 | 1/0 | 2/0 | 3/0 | 4/0 | 5/0 |
|----------|----|-----------|-----------|-----------|-----------|-----------|-----------|-----------|-----------|
| NS Black | LS | 230908(5) | 230909(5) | 230910(5) | 230911(5) | 230912(5) | 230913(4) | 230914(4) | 230915(4) |

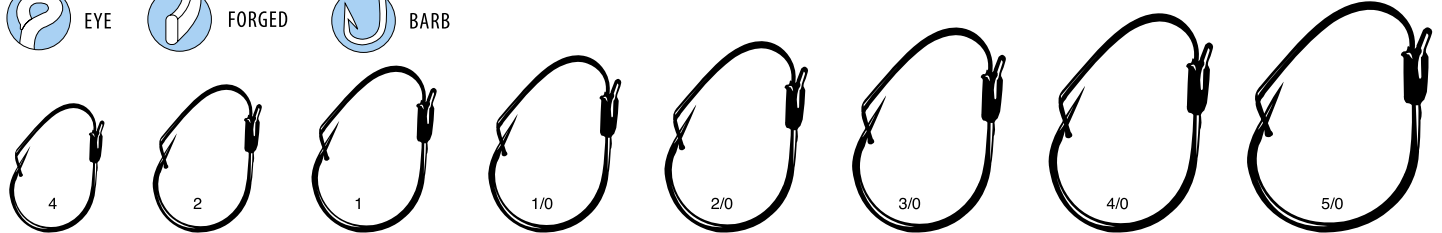

G-Stinger

The ultimate utility hook. Easily attaches to any hook or lure. Great for spinnerbaits, buzz baits, jerkbaits and jigging spoons, braided line, sizes 1-2/0 have a 50 lb. loop.

| SIZES | | 1 | 1/0 |
|----------|----|-----------|-----------|
| NS Black | LS | 219410(4) | 219411(4) |

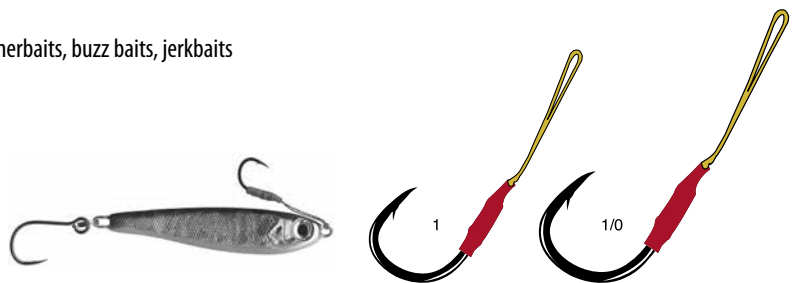

Trout Stinger

Trout Stinger Hook is an incredible offering for anglers looking for a hook with a straight eye, and a wide gap. Built with durability, and sharpness in mind, the Trout Stinger is ideal for multiple species of fish from it's namesake the freshwater Trout, all Panfish, Crappie, even small in-shore saltwater fish like Croakers, or Mullet. The no-shine black finish blends into most designs, drawing attention to the bait and not the hook.

| SIZES | | 14 | 12 | 10 | 8 |
|----------|----|------------|------------|------------|------------|
| NS Black | LS | 457203(10) | 457204(10) | 457205(10) | 457206(10) |

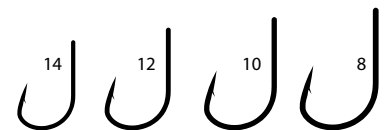

MR. CRAPPIE - WALLY MARSHALL

Stiletto

Gamakatsu teamed up with crappie legend Wally Marshall and his "Mr. Crappie" brand, the leading name in the crappie world, to design the Gamakatsu Mr. Crappie Premium Stiletto hooks. The Stiletto hook design is perfect for fishing live or dead bait due to its large gap for increased hook-ups and special bend with an acute angle providing better holding power, locking fish in place when hooked. The hooks are made from light, super-strong wire and are available in sizes from 6 through 1/0 for various applications.



| SIZES | | 6 | 4 | 2 | 1 | 1/0 |
|----------|-------|-----------|-----------|-----------|-----------|-----------|
| NS Black | LS | 453407(8) | 453408(8) | 453409(8) | 453410(8) | 453411(6) |
| | 25 pk | 453407-25 | 453408-25 | 453409-25 | 453410-25 | 453411-25 |
| Red | LS | 453307(8) | 453308(8) | 453309(8) | 453310(8) | 453311(6) |
| | 25 pk | 453307-25 | 453308-25 | 453309-25 | 453310-25 | 453311-25 |
| Gold | LS | 453207(8) | 453208(8) | 453209(8) | 453210(8) | 453211(6) |
| | 25 pk | 453207-25 | 453208-25 | 453209-25 | 453210-25 | 453211-25 |



EYE



BARB

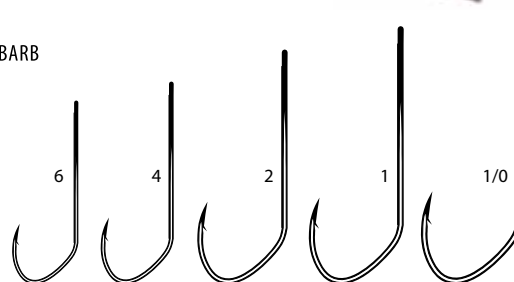

Sticker

Gamakatsu teamed up with crappie legend Wally Marshall and his "Mr. Crappie" brand, the leading name in the crappie world, to design the Gamakatsu Mr. Crappie Premium Sticker hooks. The Sticker is a traditional Aberdeen-style hook that utilizes Gamakatsu's premium grade of high carbon steel and features a perfectly conical point unequalled in sharpness. They come in gold, red and NS black, available in sizes 4 through 1/0.

| SIZES | | 4 | 2 | 1 | 1/0 |
|----------|-------|-----------|-----------|-----------|-----------|
| NS Black | LS | 454408(8) | 454409(8) | 454410(8) | 454411(6) |
| | 25 pk | 454408-25 | 454409-25 | 454410-25 | 454411-25 |
| Red | LS | 454308(8) | 454309(8) | 454310(8) | 454311(6) |
| | 25 pk | 454308-25 | 454309-25 | 454310-25 | 454311-25 |
| Gold | LS | 454208(8) | 454209(8) | 454210(8) | 454211(6) |
| | 25 pk | 454208-25 | 454209-25 | 454210-25 | 454211-25 |



EYE



BARB

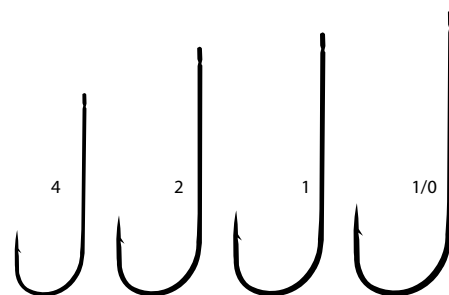

Trailer Hook SP

Speed up the process of attaching a trailer hook to your spinnerbait or buzzbait with our Trailer Sp. The hook features a rubberized coating molded on to the eye. Attaching is fast and secure.

| SIZES | | 1 | 1/0 | 2/0 | 3/0 |
|----------|----|-----------|-----------|-----------|-----------|
| NS Black | LS | 284410(5) | 284411(4) | 284412(4) | 284413(4) |
| Red | LS | 284310(5) | 284311(4) | 284312(4) | 284313(4) |



EYE



BARB

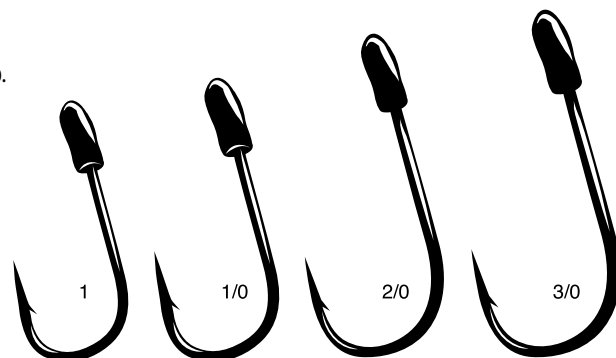

Spinner Bait Trailer Give any spinner bait or buzzbait that extra edge.

| SIZES | | 1/0 | 2/0 | 3/0 |
|--------|----|-----------|-----------|-----------|
| Nickel | LS | 210011(5) | 210012(5) | 210013(5) |
| Red | LS | 210311(5) | 210312(5) | 210313(5) |



EYE



BARB

Tube Included.

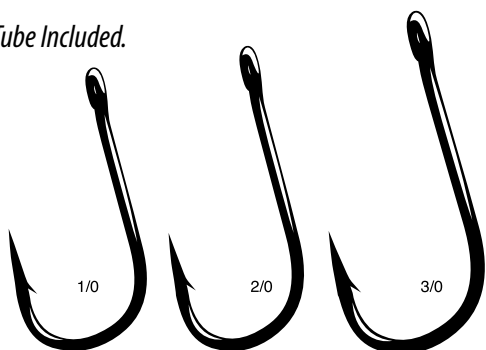

Spinner Bait

| SIZES | | 3/0 | 4/0 | 5/0 |
|--------|-----|-----------|-----------|-----------|
| Nickel | 25 | 55013-25 | 55014-25 | 55015-25 |
| | 100 | 55013-100 | 55014-100 | 55015-100 |



EYE



BARB

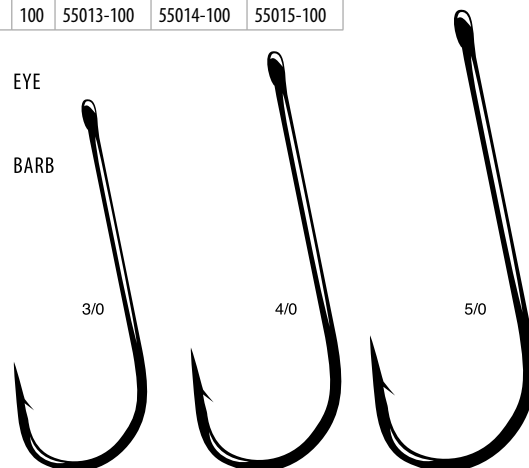

ICE FISHING-SERIES

Gamakatsu Micro Gap hooks

Offering sport fisherman the ultimate in design, the finest quality forged steel and unparalleled workmanship. Originally designed for finesse presentations for ice fishing, the Micro Gap selections are perfectly suited to many fly tying techniques as well. The fine wire design penetrates with less pressure, lessening tissue damage allowing for easier removal in catch and release fisheries. All Micro Gap hooks are finished in NS Black.

The Micro Perfect Gap hook has an up-eye design for easy snelling and optimal gap for minnows or small plastics.

The Micro Wide Gap features a straight hook eye for minnow and soft plastics.

The Micro V Gap also features a straight hook eye, but adds a deep V bend to improve retention.

Micro V Gap •

Natural & Man Made Baits
10 pk: Color: NSB

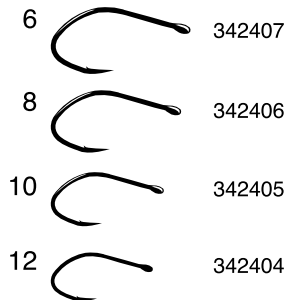

Micro Perfect Gap •

Minnow and Soft Plastics
10 pk: Color: NSB

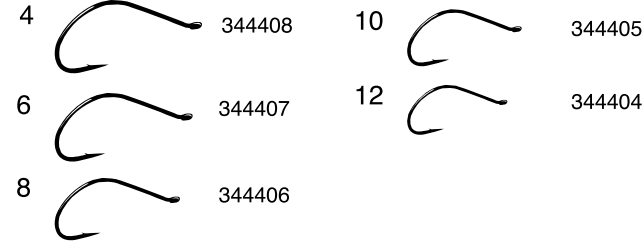

Micro Wide Gap •

Minnow and Soft Plastics
10 pk: Color: NSB

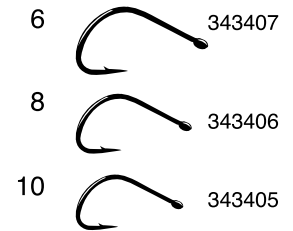

G-CARP SERIES

Gamakatsu G-Carp Hooks

We've dialed in our carp hook selection to make it the best selling line of hooks in many European countries. There's two simple points that are critical for carp – hide the hook and hold the bait. That's why we've carefully shaped all the new G-Carp hooks to hide perfectly concealed within every type of bait. Furthermore, we've included unique micro barbs to grab onto soft dough balls and putty baits and hold them in place.

All G-Carp hooks are forged for strength and feature the innovative **Nano Smooth Coat** for fast penetration.

NANO SMOOTH COAT

G-Carp Super Hook •

Natural & Man Made Baits
10 pk: Color: NSC

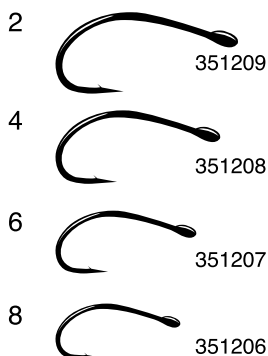

G-Carp Specialist RX •

Natural & Man Made Baits
10 pk: Color: NSC

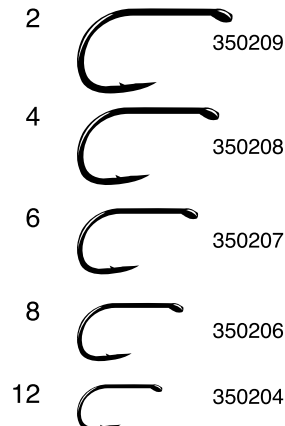

G-Carp Specialist R •

Natural & Man Made Baits
10 pk: Color: NSC

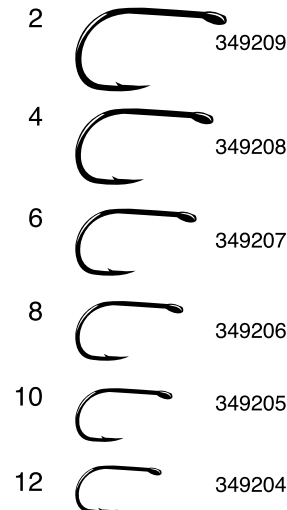

G-Carp Hump Back •

Natural & Man Made Baits
10 pk: Color: NSC

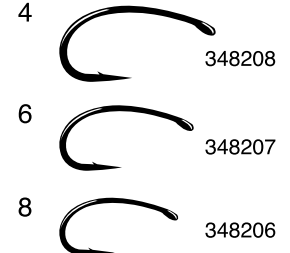

CATFISH SERIES

Catfish Circle Weedless

Bill Dance, renowned for bass fishing, is also passionate about pursuing large catfish. He collaborated with Gamakatsu to create a weedless catfish hook that can navigate dense wood cover without snagging. Bill frequently targets trophy catfish in rivers, seeking out areas with snags, laydowns, and trashpiles where these big fish reside. This innovative hook enables anglers to precisely position their baits in challenging spots while preventing snags. It is based on Gamakatsu's 221 Series Octopus Circle (Inline Point) Hook and features a custom weedguard. Gamakatsu conducted extensive tests to ensure the hook's wire weedguard allowed effective hooking while allowing fishing in the thickest, most challenging cover where large catfish hide. The circle design of this hook also promotes safe release of trophy catfish back into the water unharmed.

| SIZES | | 6/0 | 7/0 | 8/0 |
|----------|----|-----------|-----------|-----------|
| NS Black | LS | 462416(4) | 462417(4) | 462418(4) |



- EYE
- FORGED
- CIRCLE HOOK
- BARB



Big Cat Circle

There's a new dog in the fight for cat fishermen. The Gamakatsu Big Cat Circle Hook is designed specifically for tough-lipped, thick-mouthed catfish. The offset, precision sharpened hook point penetrates quickly even with light hook sets. It features an "up eye" so snelling is fast and easy. 2X strong forged steel is plenty of power for the biggest Blues -- even Wels and Mekong cats if you ever get the opportunity. It's the right hook for the job because it never stops working.

| SIZES | | 1/0 | 2/0 | 3/0 | 4/0 | 5/0 | 6/0 | 7/0 | 8/0 | 10/0 | 12/0 |
|----------|--------|-----------|-----------|-----------|-----------|-----------|-----------|-----------|-----------|-----------|-----------|
| NS Black | LS | 356411(6) | 356412(6) | 356413(6) | 356414(6) | 356415(6) | 356416(6) | 356417(5) | 356418(5) | 356420(3) | 356422(3) |
| NS Black | 25 NEW | 356411-25 | 356412-25 | 356413-25 | 356414-25 | 356415-25 | 356416-25 | 356417-25 | 356418-25 | 356420-25 | 356422-25 |

- EYE
- FORGED
- CIRCLE HOOK
- BARB
- OFF-SET POINT

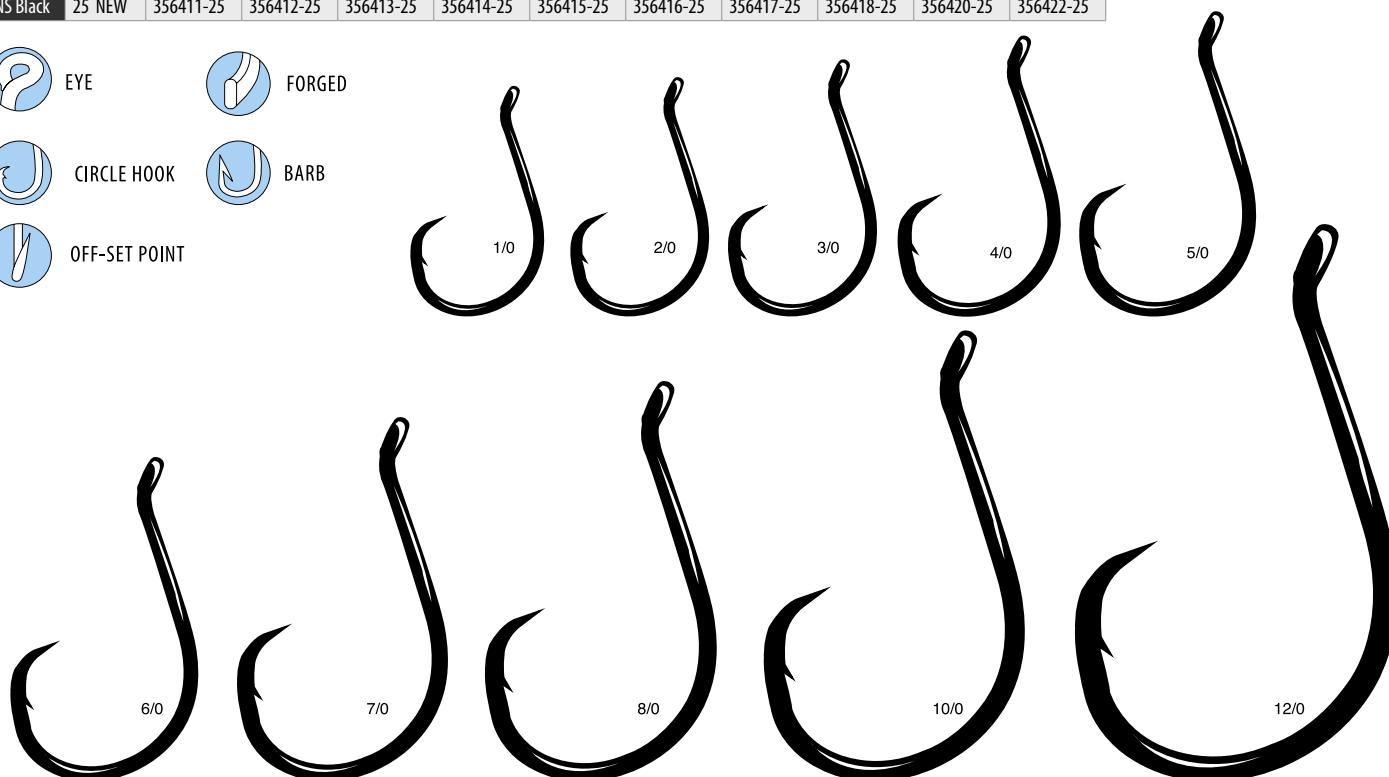

Catfish Hook Assortment

A 20 pack featuring 5 each of the best all around Catfish hooks. This pack includes 8/0 and 6/0 Octopus Circle Hooks, 4/0 Shiner Hooks, and 1/0 NS Black Baitholder hooks.

| SIZES | | VARIOUS |
|--------|----|---------|
| Assort | 20 | 258000 |

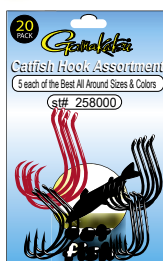



WORM HOOKS

Gamakatsu[®]

Worm, Extra Wide Gap (EWG)

Our most popular and versatile hook, the legendary EWG worm hook is the gold standard in high performance wide gap hook designs. This hook fishes a Senko to perfection. Use it to pitch a Brush Hog or Sweet Beaver to shoreline targets. It's great for Texas rigging or Carolina rigging a 10" worm. A soft plastic jerkbait fisherman's dream hook.

| SIZES | | 4 | 2 | 1 | 1/0 | 2/0 | 3/0 | 4/0 | 5/0 |
|------------|-----|-----------|-----------|-----------|-----------|-----------|-----------|-----------|-----------|
| NS Black | LS | 58408(6) | 58409(6) | 58410(6) | 58411(6) | 58412(6) | 58413(5) | 58414(5) | 58415(5) |
| | 25 | 58408-25 | 58409-25 | 58410-25 | 58411-25 | 58412-25 | 58413-25 | 58414-25 | 58415-25 |
| | 100 | 58408-100 | 58409-100 | 58410-100 | 58411-100 | 58412-100 | 58413-100 | 58414-100 | 58415-100 |
| Red | LS | 58308(6) | 58309(6) | 58310(6) | 58311(6) | 58312(6) | 58313(5) | 58314(5) | 58315(5) |
| | 25 | 58308-25 | 58309-25 | 58310-25 | 58311-25 | 58312-25 | 58313-25 | 58314-25 | 58315-25 |
| Nano Alpha | LS | | | | 58211(6) | 58212(6) | 58213(5) | 58214(5) | 58215(5) |

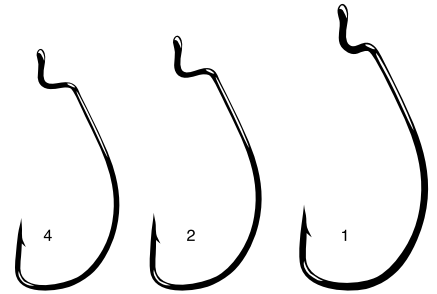

NANO ALPHA

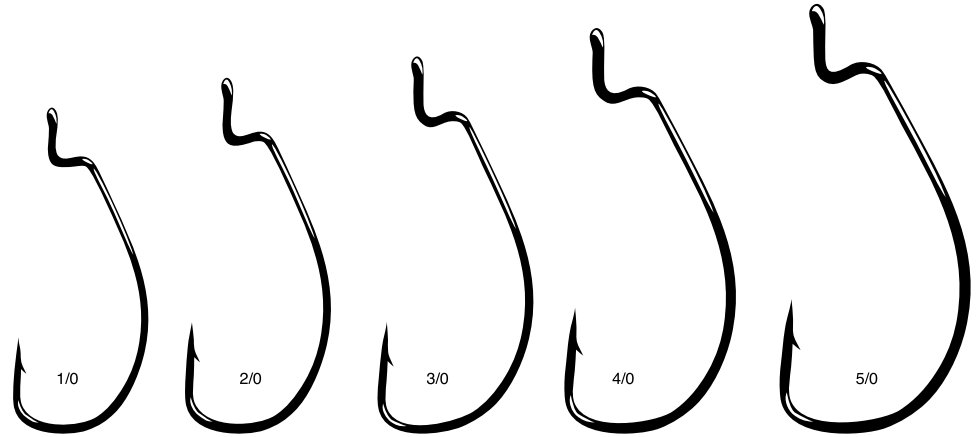

Worm, Superline Extra Wide Gap (EWG)

An EWG on steroids. This high carbon heavy wire hook was designed to fish braided line in heavy cover. For serious flipping in the tules, overhead mats, or pads. The EWG Superline will increase your strike to hook ratio when you need to get nasty. Perfect when you require a quicker descent rate without increasing size or adding weights.

| SIZES | | 2/0 | 3/0 | 4/0 | 5/0 | 6/0 |
|------------|-----|-----------|-----------|-----------|-----------|----------|
| NS Black | LS | 74412(5) | 74413(5) | 74414(4) | 74415(4) | 74416(3) |
| | 25 | 74412-25 | 74413-25 | 74414-25 | 74415-25 | 74416-25 |
| | 100 | 74412-100 | 74413-100 | 74414-100 | 74415-100 | |
| Red | LS | 74312(5) | 74313(5) | 74314(4) | 74315(4) | 74316(3) |
| Nano Alpha | LS | 74212(5) | 74213(5) | 74214(4) | 74215(4) | 74216(3) |

SuperLine NANO ALPHA

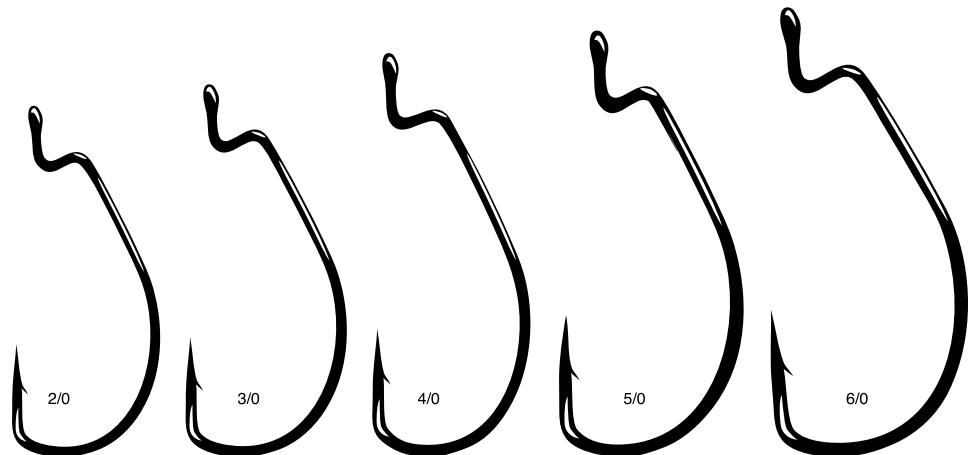

Worm, Superline EWG With Ring

There are times when calling up fish requires a little something extra. For this purpose we designed the EWG Ringed Superline. Need to fish a Horny Toad in the slop and want it to walk? Our solid piece ring allows the bait to swing freely. Fishing a Fluke for schooling smallmouth or big spots and want that super erratic action? This is your hook. Handles braided line and heavy monofilament with ease.

| SIZES | 2/0 | 4/0 |
|----------|--------------|-----------|
| NS Black | LS 74412R(4) | 74414R(4) |

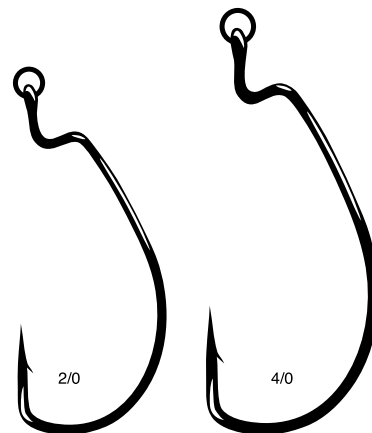

Worm, Superline EWG Weighted

The Weighted EWG Superline is a perfect compliment to the EWG arsenal. Do you need more casting distance with a soft plastic frog? This hook will get you back in the junk. Want to flip into heavy cover without the hassle of pegging a bullet sinker? Consider the EWG Weighted Superline your new best friend. The Lead is strategically placed and milled to perfection.

| SIZES | 2/0 - 1/16 | 2/0 - 1/8 | 3/0 - 1/16 | 3/0 - 1/8 | 4/0 - 1/16 | 4/0 - 1/8 | 5/0 - 1/16 | 5/0 - 1/8 |
|----------|------------------|--------------|---------------|--------------|---------------|--------------|---------------|--------------|
| NS Black | LS 74412-1/16(5) | 74412-1/8(5) | 74413-1/16(5) | 74413-1/8(5) | 74414-1/16(5) | 74414-1/8(5) | 74415-1/16(5) | 74415-1/8(5) |

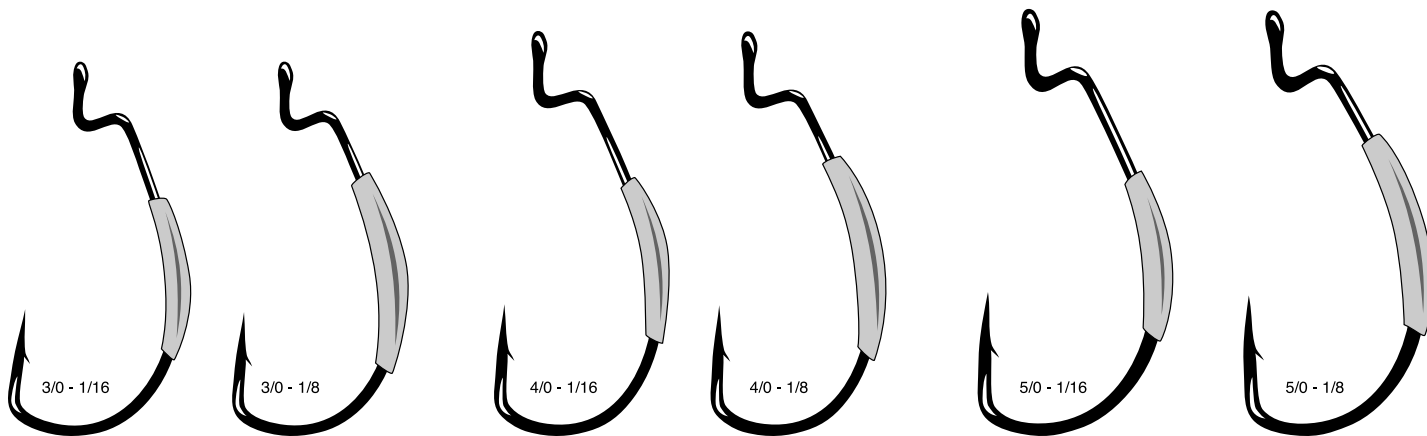
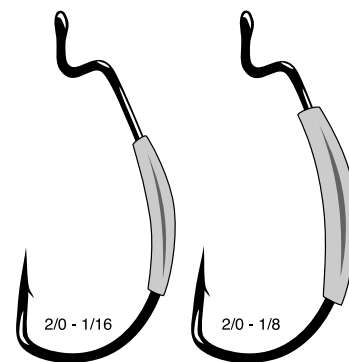

EWG Worm Hook Assortment

A 25 pack featuring 5 each of the best all around worm hook sizes and colors. It includes 2 Red and 3 NS Black hooks in 3/0 and 4/0 Superline EWG, and the standard EWG in 2/0, 3/0 and 4/0.

| SIZES | VARIOUS | |
|--------|---------|--------|
| Assort | 25 | 257000 |

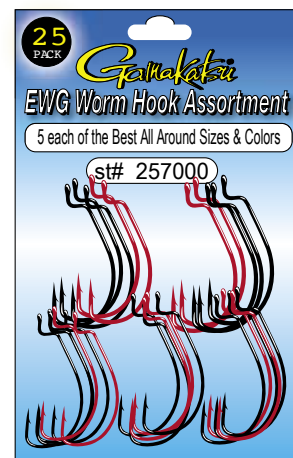

Extra Wide Gap (EWG) Monster

When only a high carbon heavy wire hook will do your choice should be the EWG Monster. Hard core doesn't even begin to describe the Monster. Slings a Mission Fish back in the cover? We now have the perfect hook. Loading for bear with a giant Gitzit, Double Wide Beaver, or oversized Slug-O? The Monster has you covered. Headed to El Salto, Clear Lake, or the California Delta for double digit behemoths? Gamakatsu Monster is the choice when you are taking no prisoners. Heavy line, heavy rods, big baits, and big fish is EWG Monster time!

| SIZES | | 5/0 | 6/0 | 7/0 |
|----------|----|-----------|-----------|-----------|
| NS Black | LS | 283415(5) | 283416(4) | 283417(4) |

- EYE
- FORGED
- BARB
- EWG - EXTRA WIDE GAP

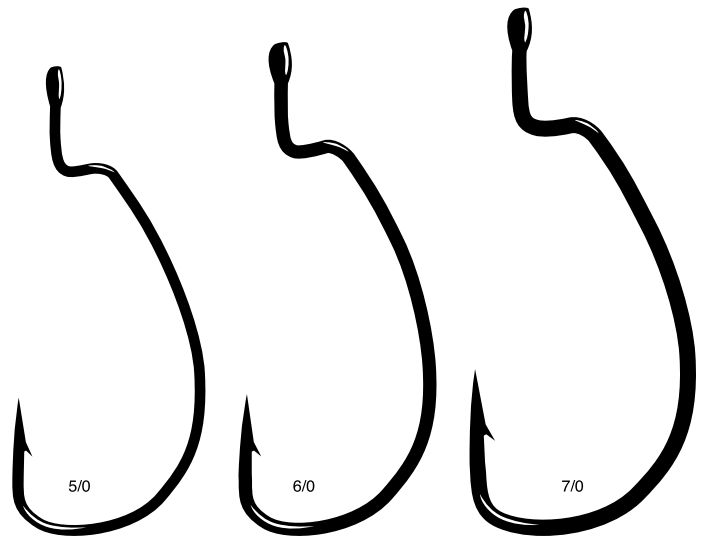

Extra Wide Gap (EWG) Monster, Weighted

On the heels of the EWG Monster we have introduced the Weighted Monster. When the situation calls for a bulletproof weighted hook, look no further than the Monster Weighted. Strategically placed milled weights are perfectly balanced and serve as a keel for large swimbaits or any oversized offering. The hook also features a slightly higher hook point in relation to the eye to help aid in hook setting power.

| SIZES | | 5/0 - 1/8 | 5/0 - 1/4 | 6/0 - 3/16 | 6/0 - 1/4 | 7/0 - 1/4 | 7/0 - 3/8 |
|----------|----|---------------|---------------|----------------|---------------|---------------|---------------|
| NS Black | LS | 283415-1/8(3) | 283415-1/4(3) | 283416-3/16(3) | 283416-1/4(3) | 283417-1/4(3) | 283417-3/8(3) |

- EYE
- FORGED
- BARB
- EWG - EXTRA WIDE GAP

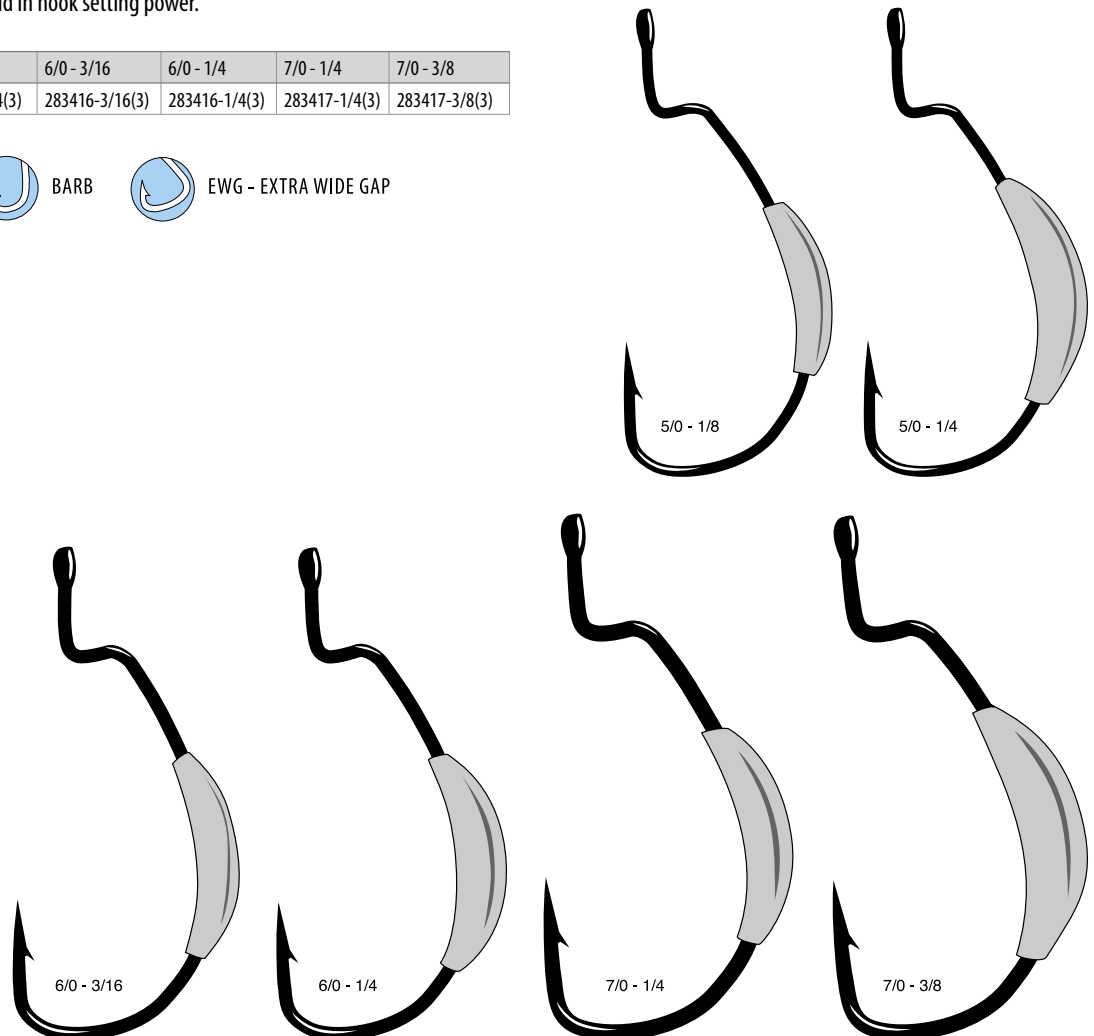

Worm G-Lock

The unique G-Lock hook locks soft plastics tight and secure in any situation. Designed to be used in heavy cover.

| SIZES | | 2 | 1 | 1/0 | 2/0 | 3/0 | 4/0 | 5/0 |
|----------|----|-----------|-----------|-----------|-----------|-----------|-----------|-----------|
| NS Black | LS | 204409(6) | 204410(6) | 204411(6) | 204412(6) | 204413(5) | 204414(5) | 204415(5) |
| | 25 | | | 204411-25 | 204412-25 | 204413-25 | 204414-25 | 204415-25 |

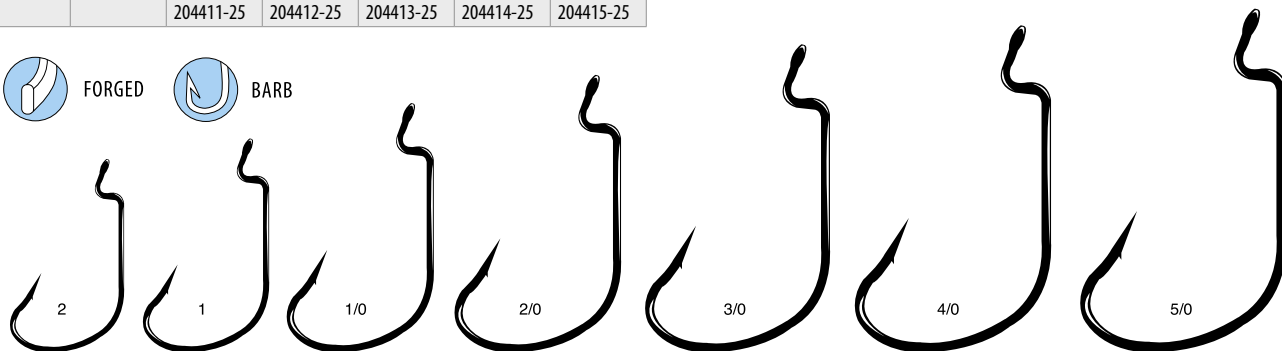

Worm 34R

A proven JDM design, the Worm 34R is built with premium Tournament Grade Wire (TGW)—thinner, stronger, and sharper than traditional wire—and finished with Nano Alpha for smoother penetration and superior corrosion resistance. Its narrow gap boosts hookup ratios on short strikes, while its versatile design excels with stick worms, curly tails, and a wide range of soft plastics.

| SIZES | | 1/0 | 2/0 | 3/0 | 4/0 | 5/0 | 6/0 |
|------------|----|-----------|-----------|-----------|-----------|-----------|-----------|
| Nano Alpha | LS | 468211(5) | 468212(5) | 468213(5) | 468214(5) | 468215(4) | 468216(4) |

NANO ALPHA

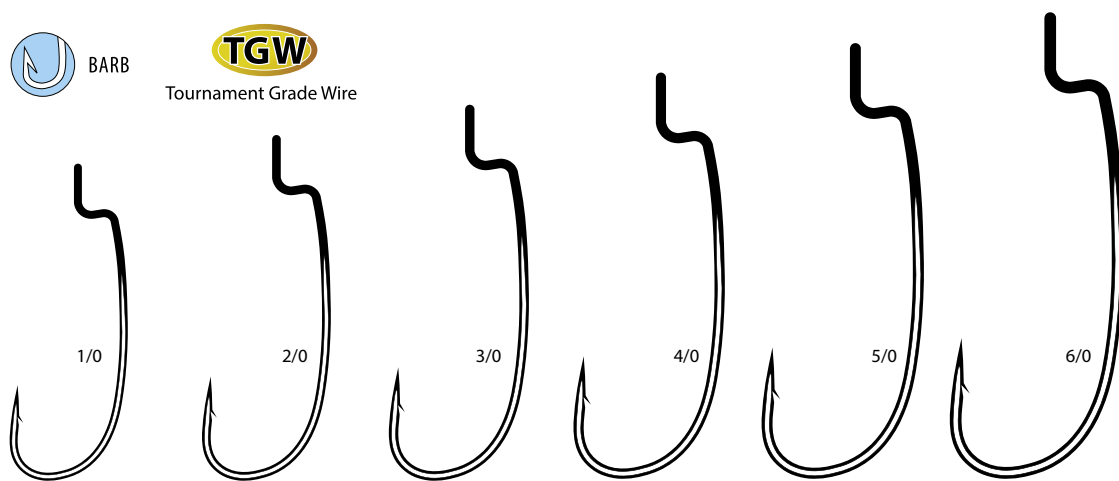

Worm 34R Hydroll

Designed by Japanese angler Mr. Takeru Tomimoto, the Worm 34R Hydroll features a compact, narrow gap design with an integrated swivel to reduce line twist and improve performance in heavy cover. Built from premium Tournament Grade Wire (TGW), it's thinner, stronger, and sharper, while the embedded swivel adds subtle weight without extra sinkers—ideal for scat and fluke-style baits.

| SIZES | | 1/0 | 2/0 | 3/0 | 4/0 | 5/0 | 6/0 |
|----------|----|-----------|-----------|-----------|-----------|-----------|-----------|
| NS Black | LS | 471411(4) | 471412(4) | 471413(4) | 471414(3) | 471415(3) | 471416(3) |



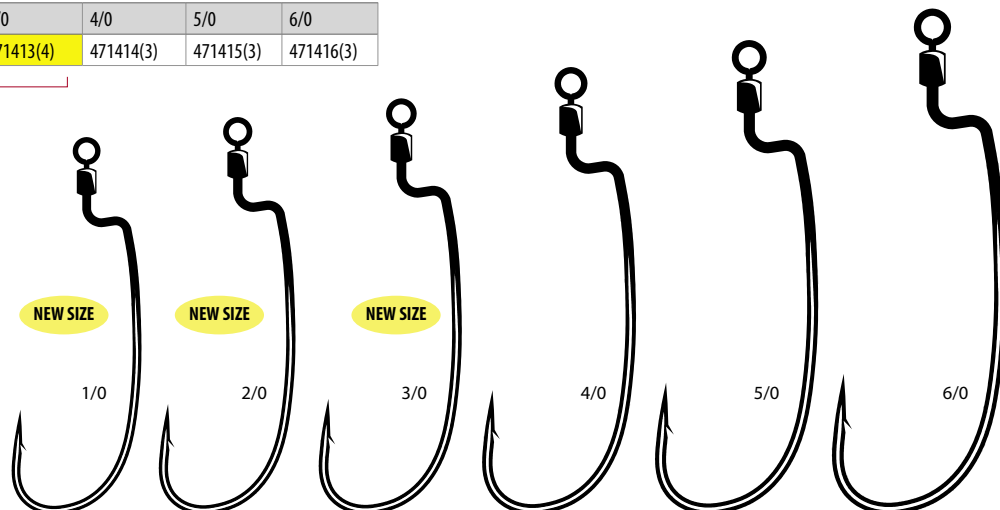

NEW SIZES



Worm, Deep Throat Wide Gap

The deeper throat, extended point, and locking offset make this a good hook for soft plastic frog baits.

| SIZES | | 1/0 | 2/0 | 3/0 | 4/0 | 5/0 |
|----------|-------|-----------|-----------|-----------|-----------|-----------|
| NS Black | LS | 242411(6) | 242412(6) | 242413(5) | 242414(5) | 242415(5) |
| | 25 pk | 242411-25 | 242412-25 | 242413-25 | 242414-25 | 242415-25 |

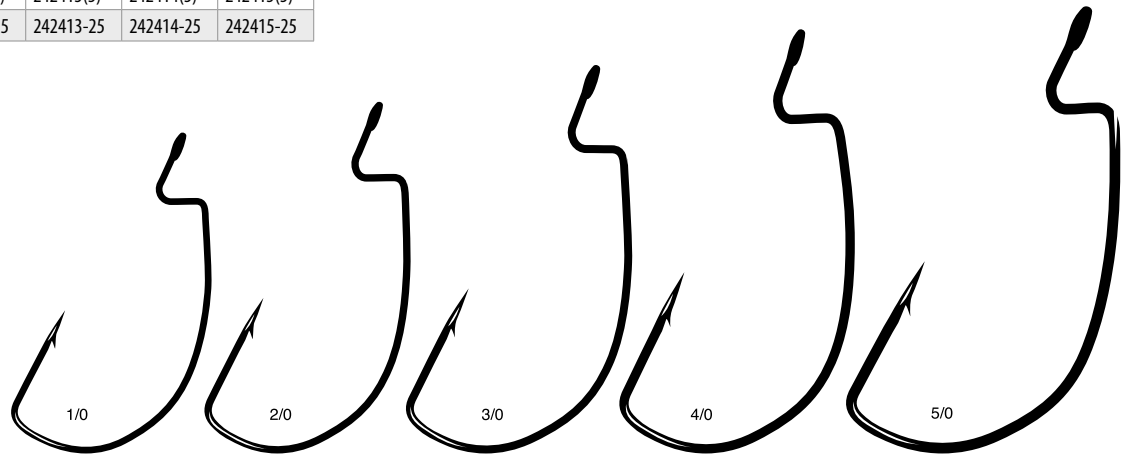

-  EYE
-  FORGED
-  BARB
-  EWG - EXTRA WIDE GAP



Worm, Offset Shank, O'Shaughnessy Bend

This is our standard offset shank worm hook. The O'Shaughnessy bend is preferred by many top Pro's for a variety of soft plastic rigging.

| SIZES | | 2 | 1 | 1/0 | 2/0 | 3/0 | 4/0 | 5/0 |
|------------|-----|-----------|-----------|-----------|-----------|-----------|-----------|-----------|
| Bronze | LS | 07109(6) | 07110(6) | 07111(6) | 07112(6) | 07113(5) | 07114(5) | 07115(5) |
| | 25 | 07109-25 | 07110-25 | 07111-25 | 07112-25 | 07113-25 | 07114-25 | 07115-25 |
| | 100 | 07109-100 | 07110-100 | 07111-100 | 07112-100 | 07113-100 | 07114-100 | 07115-100 |
| NS Black | LS | 07409(6) | 07410(6) | 07411(6) | 07412(6) | 07413(5) | 07414(5) | 07415(5) |
| | 25 | 07409-25 | 07410-25 | 07411-25 | 07412-25 | 07413-25 | 07414-25 | 07415-25 |
| | 100 | 07409-100 | 07410-100 | 07411-100 | 07412-100 | 07413-100 | 07414-100 | 07415-100 |
| Nano Alpha | LS | | | 07211(6) | 07212(6) | 07213(5) | 07214(5) | 07215(5) |

-  EYE
-  FORGED
-  BARB

NANO ALPHA

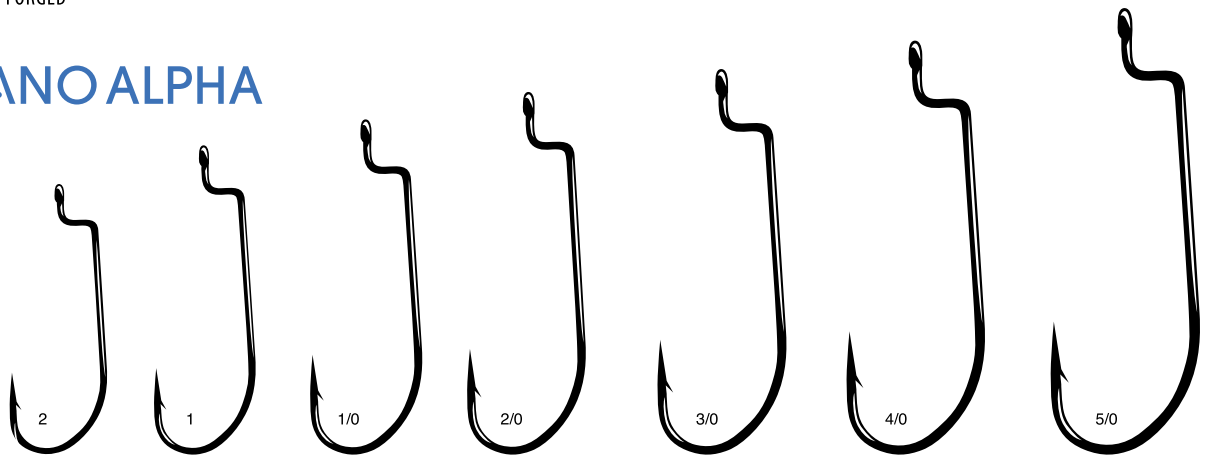

Worm, Offset Shank, Round Bend

Our standard offset shank hook with a round bend to give a larger bite area. Perfect for Carolina rigging, or any time you need a stealthy presentation.

| SIZES | | 1/0 | 2/0 | 3/0 | 4/0 | 5/0 |
|------------|-----|-----------|-----------|-----------|-----------|-----------|
| Bronze | LS | 54111(6) | 54112(6) | 54113(5) | 54114(5) | 54115(5) |
| | 25 | 54111-25 | 54112-25 | 54113-25 | 54114-25 | 54115-25 |
| | 100 | 54111-100 | 54112-100 | 54113-100 | 54114-100 | 54115-100 |
| NS Black | LS | 54411(6) | 54412(6) | 54413(5) | 54414(5) | 54415(5) |
| | 25 | 54411-25 | 54412-25 | 54413-25 | 54414-25 | 54415-25 |
| | 100 | 54411-100 | 54412-100 | 54413-100 | 54414-100 | 54415-100 |
| Red | LS | 54311(6) | 54312(6) | 54313(5) | 54314(5) | |
| Nano Alpha | LS | 54211(6) | 54212(6) | 54213(5) | 54214(5) | 54215(5) |

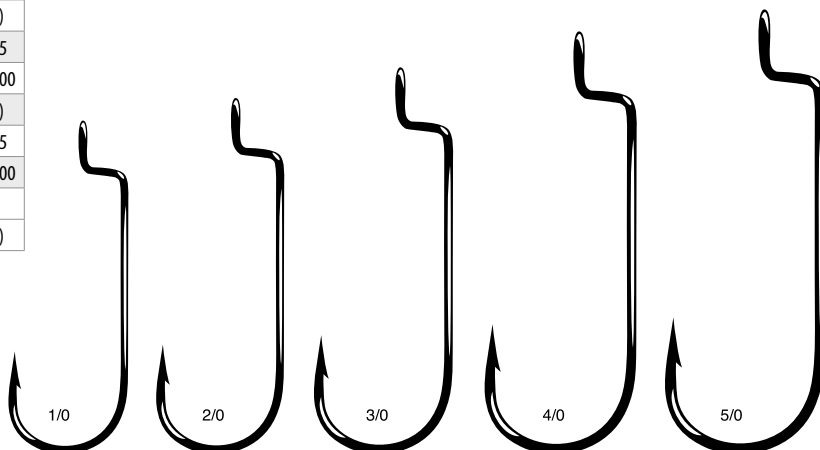

Worm, Superline, Offset, Round Bend

Gamakatsu's Superline Offset Round Bend is designed with a heavier Superline wire best suited for heavy braided and fluorocarbon lines. This popular design in heavy wire enables anglers to fish any plastic in the heaviest of cover with no worries. The Round Bend offers a larger bite area perfect for any worm presentation while increasing your hook-up ratios. The newly enhanced Z-Bend holds your plastics on the hook longer, reducing the number of pull-offs and reducing damage to plastics. A more durable worm hook designed for heavier lines that hold your bait on longer.

| SIZES | | 2/0 | 3/0 | 4/0 | 5/0 |
|----------|----|------------|-----------|-----------|-----------|
| NS Black | LS | 398412 (5) | 398413(5) | 398414(4) | 398415(4) |

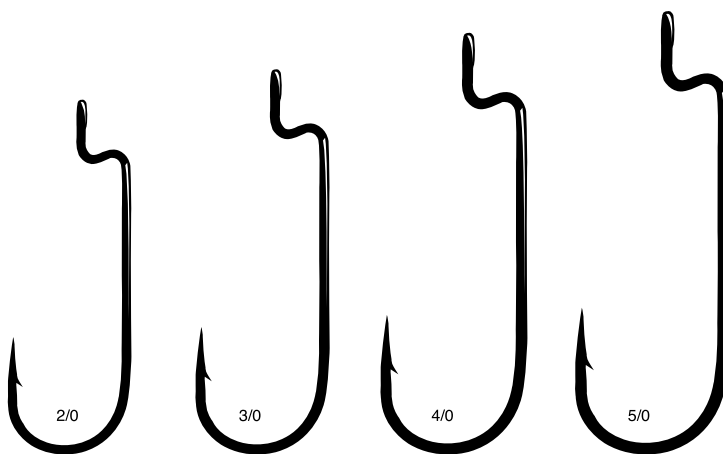

Worm, Skip Gap

There is no better hook for skipping plastics under docks and cover. The Skip Gap is a multiple use hook that is perfect for a variety of soft plastic baits. Top water buzz frogs, Texas rigging, Carolina rigging, the Skip Gap can do it all!

| SIZES | | 1/0 | 2/0 | 3/0 | 4/0 | 5/0 |
|----------|----|-----------|-----------|-----------|-----------|-----------|
| NS Black | LS | 266411(6) | 266412(6) | 266413(5) | 266414(5) | 266415(5) |
| | 25 | 266411-25 | 266412-25 | 266413-25 | 266414-25 | 266415-25 |

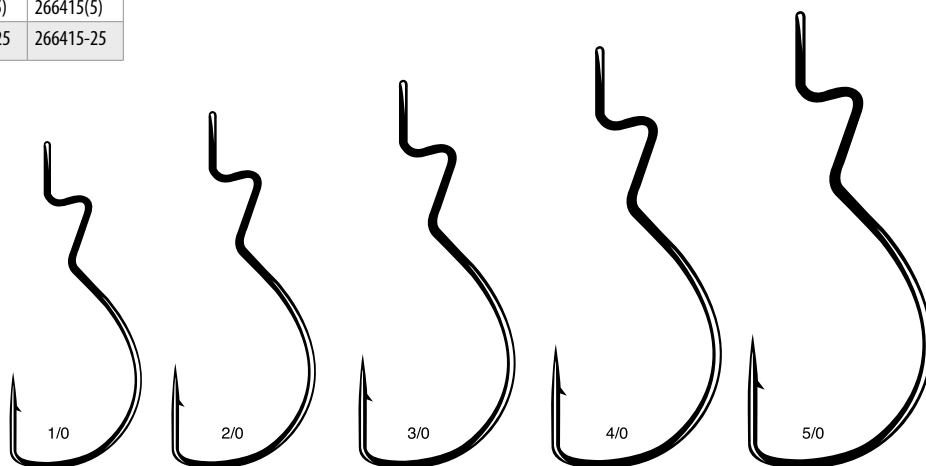

Worm, Straight Shank, O'Shaughnessy Bend

Our standard straight shank worm hook.

| SIZES | | 2 | 1 | 1/0 | 2/0 | 3/0 | 4/0 | 5/0 |
|----------|-----|-----------|-----------|-----------|-----------|-----------|-----------|-----------|
| Bronze | LS | 01109(6) | 01110(6) | 01111(6) | 01112(6) | 01113(5) | 01114(5) | 01115(5) |
| | 25 | 01109-25 | 01110-25 | 01111-25 | 01112-25 | 01113-25 | 01114-25 | 01115-25 |
| | 100 | 01109-100 | 01110-100 | 01111-100 | 01112-100 | 01113-100 | 01114-100 | 01115-100 |
| NS Black | LS | 01409(6) | 01410(6) | 01411(6) | 01412(6) | 01413(5) | 01414(5) | 01415(5) |
| | 25 | 01409-25 | 01410-25 | 01411-25 | 01412-25 | 01413-25 | 01414-25 | 01415-25 |
| | 100 | 01409-100 | 01410-100 | 01411-100 | 01412-100 | 01413-100 | 01414-100 | 01415-100 |

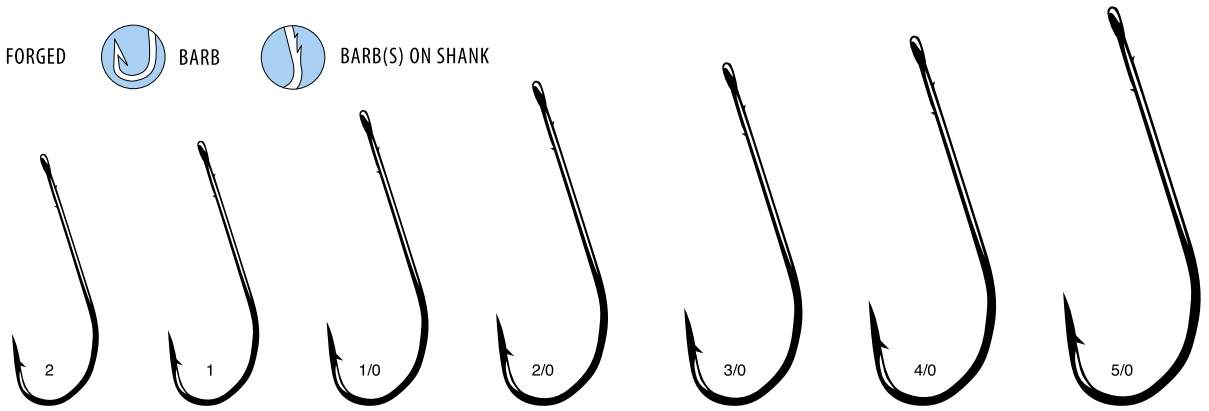

Worm, Straight Shank, Wire Guard

Like our popular standard worm hook, only with a weed guard.

| SIZES | | 1 | 1/0 | 2/0 | 3/0 | 4/0 | 5/0 |
|--------|----|----------|----------|----------|----------|----------|----------|
| Bronze | LS | 65110(4) | 65111(4) | 65112(4) | 65113(3) | 65114(3) | 65115(3) |

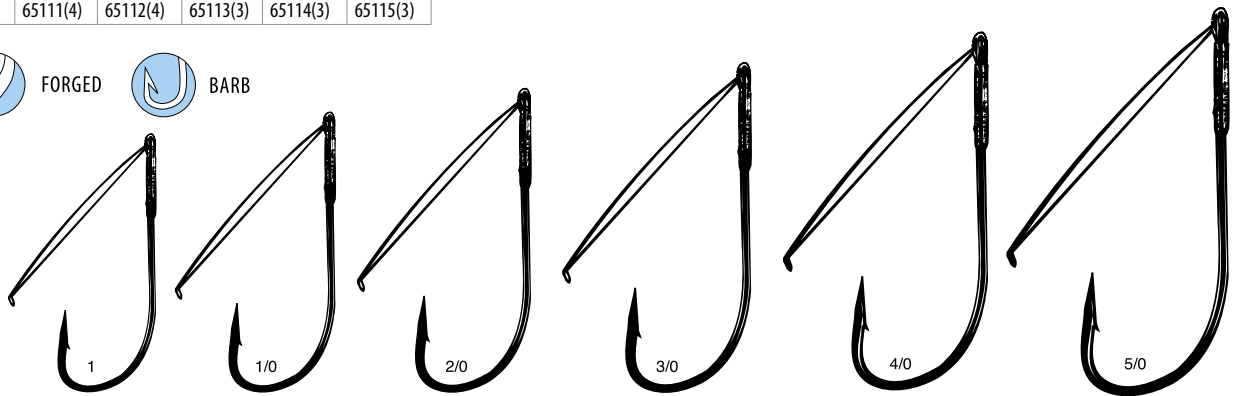

Worm, Straight Shank, Light Wire

We have all you finesse fishermen covered with this worm hook. The Light Wire excels when the bite gets tough.

| SIZES | | 2 | 1 | 1/0 | 2/0 |
|----------|-----|-----------|-----------|-----------|-----------|
| NS Black | LS | 49409(6) | 49410(6) | 49411(6) | 49412(6) |
| | 25 | 49409-25 | 49410-25 | 49411-25 | 49412-25 |
| | 100 | 49409-100 | 49410-100 | 49411-100 | 49412-100 |

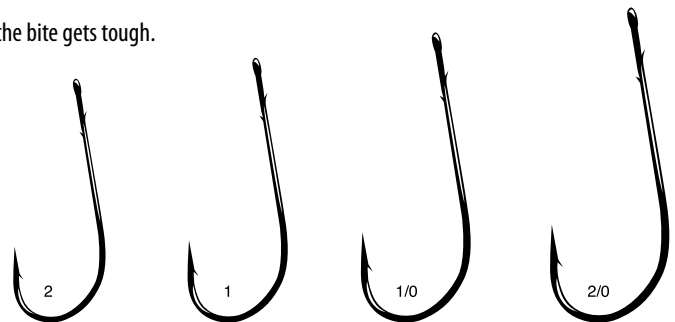

Worm, Straight Shank Round Bend

Perfect round bend for a wider bite area and superior holding power.

| SIZES | | 1/0 | 2/0 | 3/0 | 4/0 | 5/0 |
|----------|-----|-----------|-----------|-----------|-----------|-----------|
| NS Black | LS | 48411(6) | 48412(6) | 48413(5) | 48414(5) | 48415(5) |
| | 25 | 48411-25 | 48412-25 | 48413-25 | 48414-25 | 48415-25 |
| | 100 | 48411-100 | 48412-100 | 48413-100 | 48414-100 | 48415-100 |

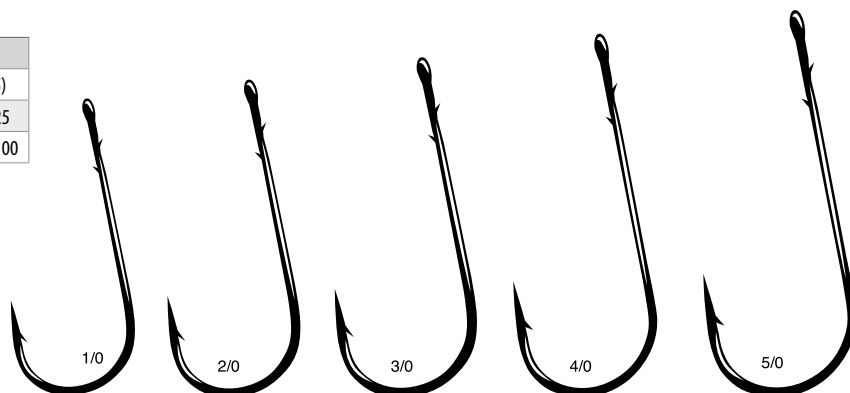

Finesse Heavy Cover Worm

The Finesse Heavy Cover Worm Hook is a light wire, finesse hook that features the first wide gap straight shank hook for finesse worm fishing. Just like all the Heavy Cover Hooks the Finesse features a welded eye and tin keeper that assures your worm doesn't slide down the hook.

| SIZES | | 1/0 | 2/0 | 3/0 |
|----------|----|-----------|-----------|-----------|
| NS Black | LS | 311411(4) | 311412(4) | 311413(4) |

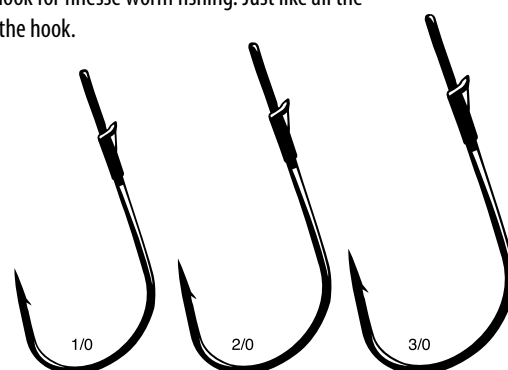

Heavy Cover Worm

The Heavy Cover Worm hook has been built to the highest standards to fight the biggest fish in the heaviest cover. The Heavy Cover Worm features our rock solid welded eye, perfect for tying a Snell knot with braid. Gamakatsu has worked with our top pros to design an improved keeper. Instead of a bulky heat shrink barb, the Heavy Cover Worm features a small tin keeper. The keeper has a small compact profile and is strategically placed for superior holding power.

| SIZES | | 3/0 | 4/0 | 5/0 |
|----------|----|-----------|-----------|-----------|
| NS Black | LS | 304413(4) | 304414(4) | 304415(4) |

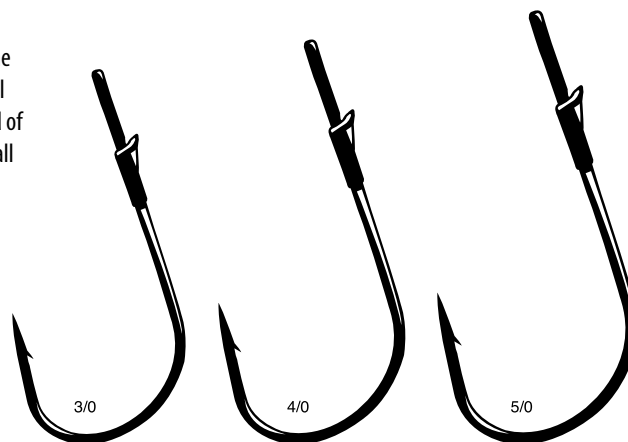

Super Heavy Cover Worm

The Super Heavy Cover Worm Hook is indestructible with a welded eye and extra heavy duty cold-forged hook wire that will not flex. It's perfect for flipping into heavy cover or punching through thick overhead cover. The addition of an oversized barb holds hooked fish solid and the improved tin keeper firmly secures worms so they stay rigged cast-after-cast.

| SIZES | | 3/0 | 4/0 | 5/0 |
|----------|----|-----------|-----------|-----------|
| NS Black | LS | 310413(4) | 310414(4) | 310415(4) |

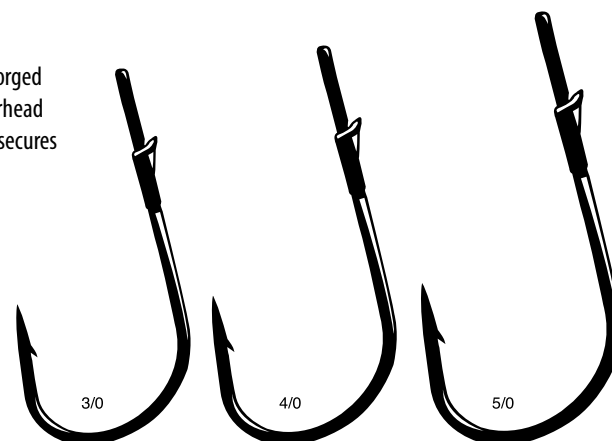

Gika Rig

Gika Rig combines the natural presentation of finesse fishing with the speed of power fishing. The Gika Rig uses an off-set shank worm hook with an elongated drop shot style weight attached directly to the eye via a solid ring. The position of the weight allows anglers to ‘feel’ the bottom, detecting transitions in composition and helping find fish-holding structures. Gika Rig produces a natural swimming and dropping motion. The solid ring allows the plastic bait to float freely and rotate from side to side as it descends. It slips through vegetation with ease and grabs the attention of bass.

| SIZES | 2/0-1/8 | 2/0-3/16 | 3/0-3/16 | 3/0-1/4 | 4/0-1/4 | 4/0-3/8 |
|-------|-------------------|-----------------|----------------|---------------|----------------|----------------|
| Black | LS 399412-1/8 (2) | 399412-3/16 (2) | 399413-3/16(2) | 399413-1/4(2) | 399414-1/4 (2) | 399414-3/8 (2) |

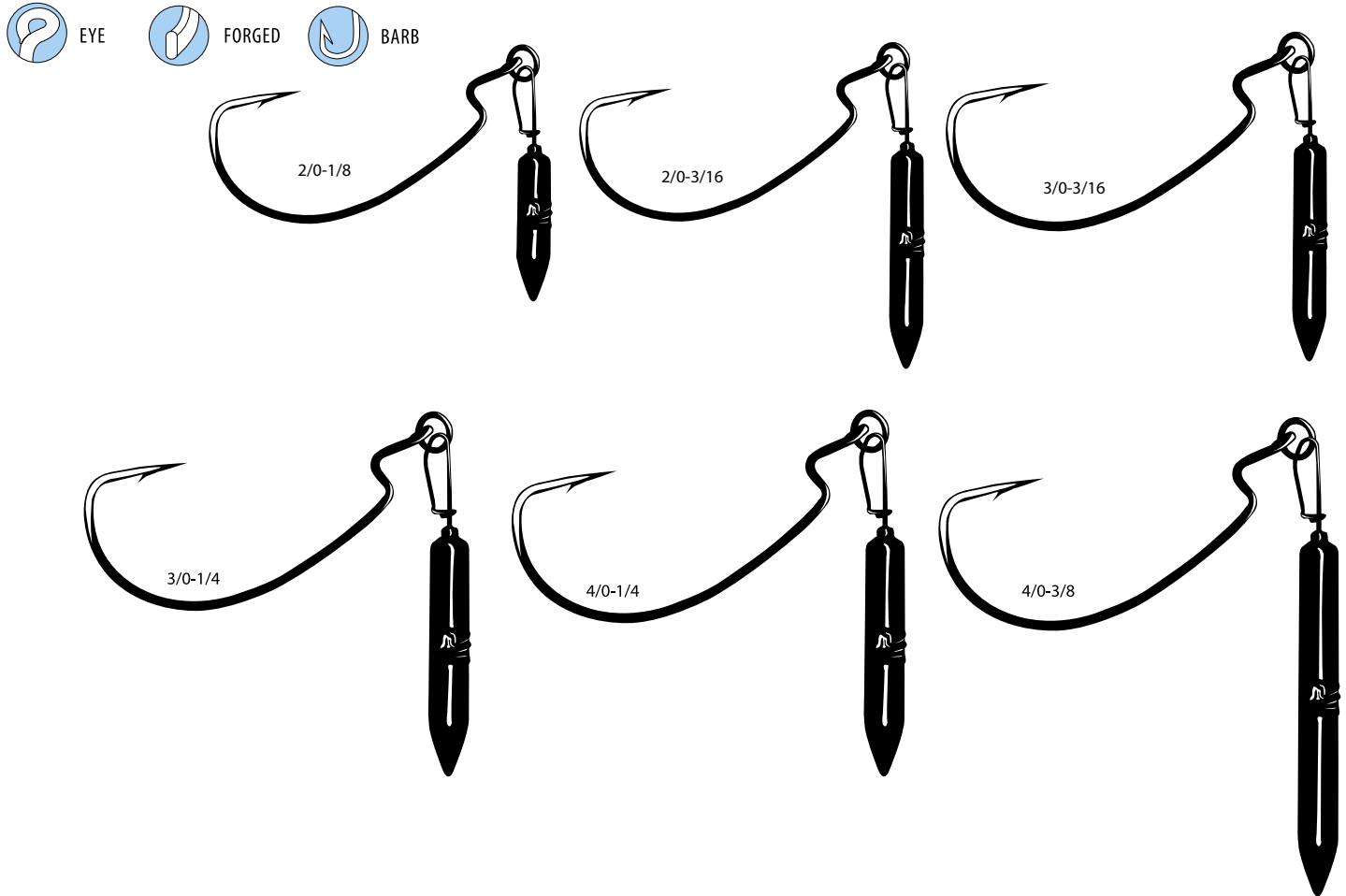

Gika Rig Weight

Gika Rig weights attach directly to the Gika Rig eye via a solid ring. The weight features a snap that allows anglers to quickly change the size of the weight when the situation calls for it and is painted black for stealthy presentations. The weight size is permanently stamped into the side of each weight making it easy to identify when it's time to make a change. Changing weights controls the depth and drop speed of the bait adding to the rig's versatility.



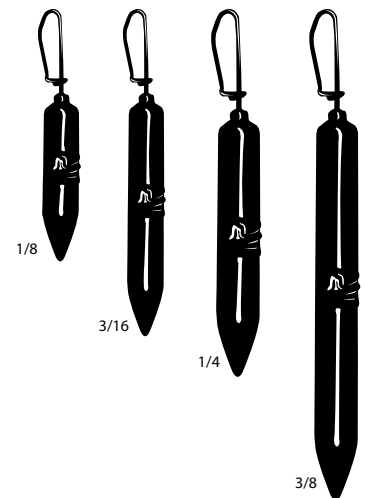

| SIZES | 1/8 | 3/16 | 1/4 | 3/8 |
|-------|------------------|----------------|---------------|---------------|
| Black | LS 400400-1/8(4) | 400400-3/16(4) | 400400-1/4(4) | 400400-3/8(4) |



Superline Spring Lock

The Superline Spring Lock is based on the proven Superline EWG. The Spring Lock features a 28 degree eye with a stress relieved stainless steel center point spring lock. This is the ideal soft plastic hook when the situation requires your bait to stay locked and secure.

| SIZES | 3/0 | 4/0 | 5/0 | 6/0 | 7/0 |
|-------------|-----------|-----------|-----------|-----------|-----------|
| NS Black LS | 296413(3) | 296414(3) | 296415(3) | 296416(2) | 296417(2) |

-  EYE
-  FORGED
-  BARB
-  EWG - EXTRA WIDE GAP

SuperLine

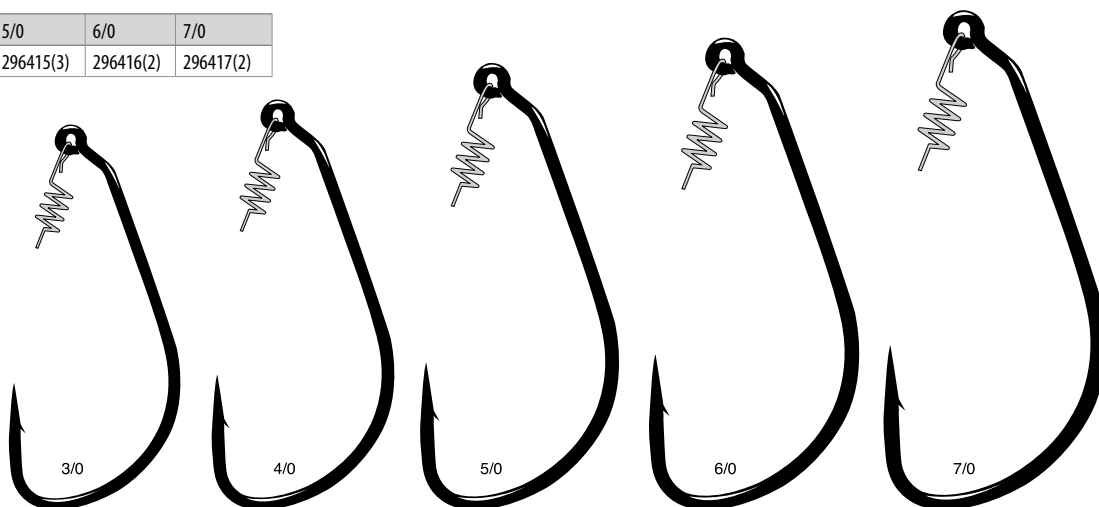

Superline Spring Lock, Weighted

We designed the EWG Spring-Lock to be the perfect hook for paddle tail swim baits. Based on the proven Superline EWG hook, the Spring Lock features a new 28 degree eye with a stress relieved stainless steel center point spring lock so baits stay locked and secure. Beautifully milled, strategically placed weights help your bait track perfectly at any depth. Offered in a variety of sizes and weights to take your paddle tail swim bait fishing to a new level.

| SIZES | 3/0 - 1/16 | 3/0 - 1/8 | 4/0 - 1/16 | 4/0 - 1/8 | 5/0 - 3/16 | 5/0 - 1/4 | 6/0 - 3/16 | 6/0 - 1/4 | 7/0 - 1/4 | 7/0 - 3/8 |
|-------------|----------------|---------------|----------------|---------------|----------------|---------------|----------------|---------------|---------------|---------------|
| NS Black LS | 296413-1/16(4) | 296413-1/8(4) | 296414-1/16(4) | 296414-1/8(4) | 296415-3/16(4) | 296415-1/4(4) | 296416-3/16(4) | 296416-1/4(4) | 296417-1/4(4) | 296417-3/8(4) |

-  EYE
-  FORGED
-  BARB
-  EWG - EXTRA WIDE GAP

SuperLine

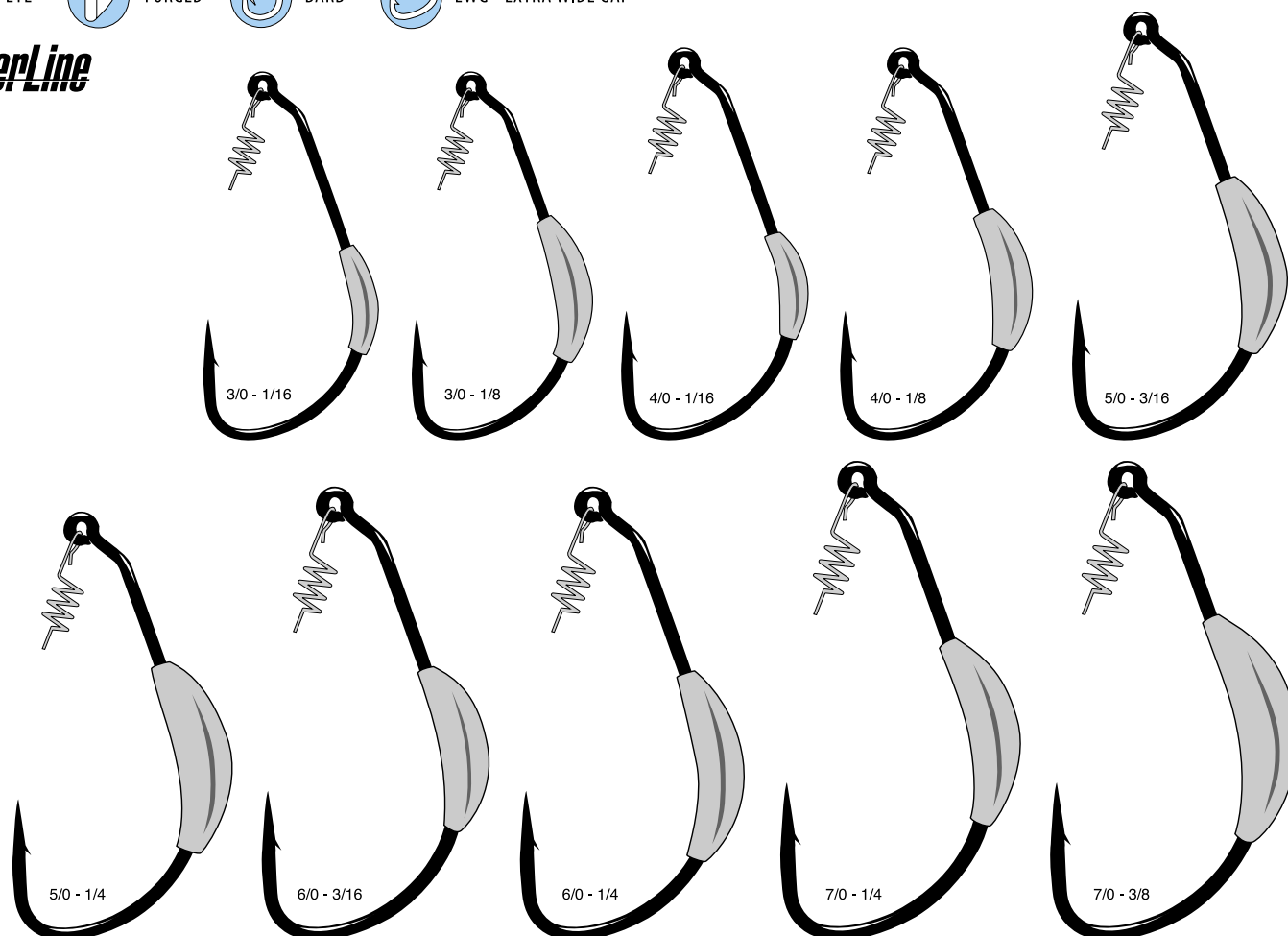

Superline Spring Lock Monster, Weighted

Go big or go home. When conditions call for big baits, Gamakatsu's new Spring Lock Monster is precisely designed to hold and position them perfectly straight and firmly attached. Weighted with 3/8 or 1/2 ounce lead, the Spring Lock Monster stands up to aggressive casts and viciously hard hook sets. The "center point" spring lock is easy to start and tighten. Baits stay straight every time and all the time. 9/0, 10/0 or 12/0 hook sizes await trophy-caliber catches.

| SIZES | | 9/0 - 3/8 | 10/0 - 3/8 | 12/0 - 3/8 | 9/0 - 1/2 | 10/0 - 1/2 | 12/0 - 1/2 |
|----------|----|---------------|---------------|---------------|---------------|---------------|---------------|
| NS Black | LS | 371419-3/8(3) | 371420-3/8(2) | 371422-3/8(2) | 371419-1/2(3) | 371420-1/2(2) | 371422-1/2(2) |

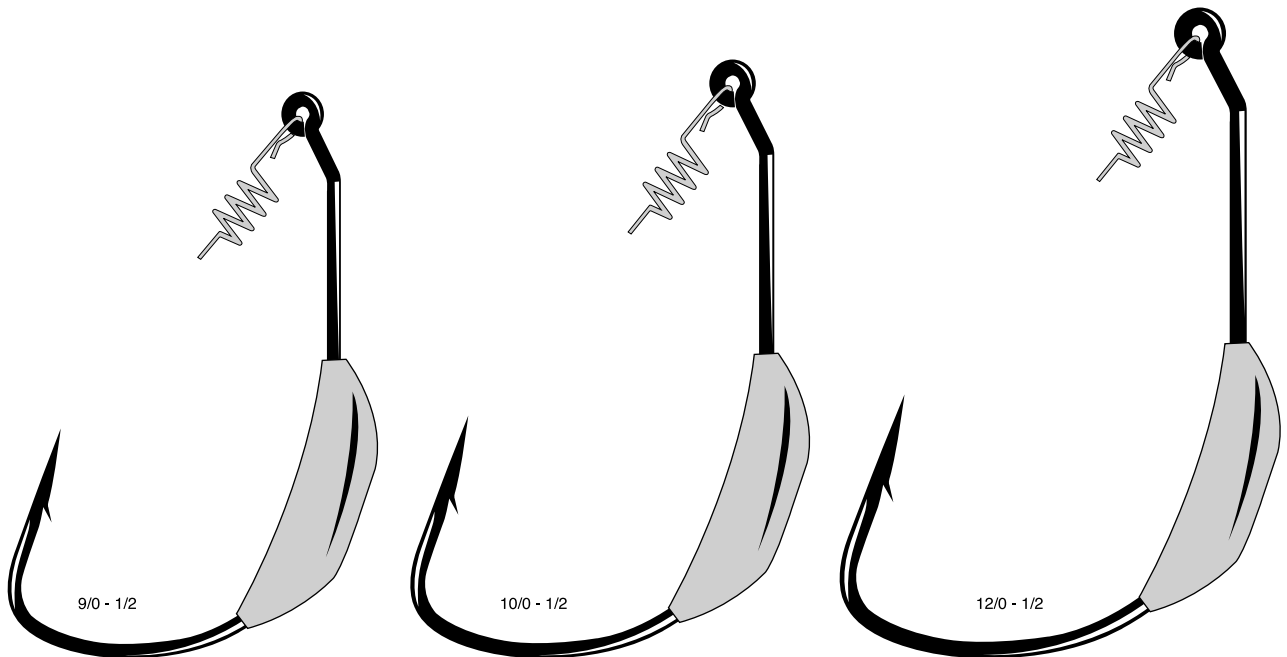
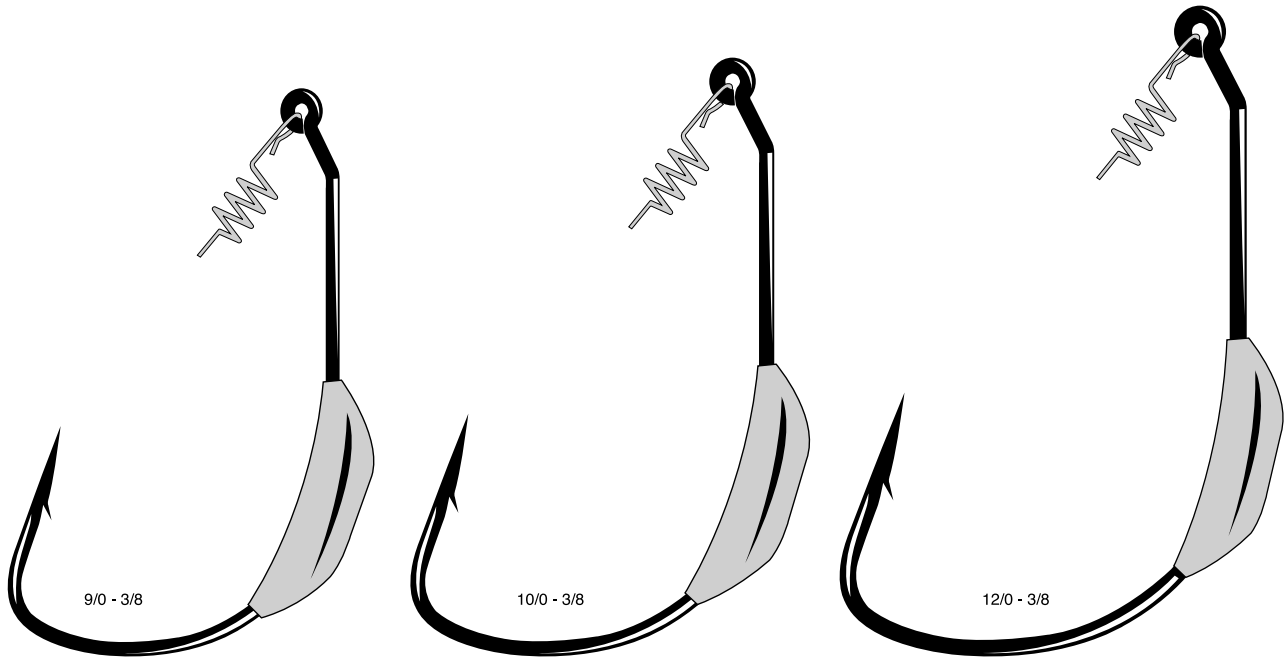

Power Drop with Superline EWG

The Power Drop series is uniquely built around a solid ring that connects the premium hook, swivel and a 3.5-inch dropper wire. The Superline EWG is considered the gold standard in high-performance wide-gap hook designs; this option features our Superline EWG 744XX series hooks. The premium Gamakatsu swivel completes each rig to prevent line twists. Simply add the desired weight to the dropper wire then bend the end of the shaft with a pair of needle nose pliers to secure in place.

| SIZES | | 2/0 | 3/0 | 4/0 | 5/0 | 6/0 |
|----------|----|-----------|-----------|-----------|-----------|-----------|
| NS Black | LS | 402412(2) | 402413(2) | 402414(2) | 402415(2) | 402416(2) |

-  EYE
-  FORGED
-  BARB
-  EWG - EXTRA WIDE GAP

SuperLine

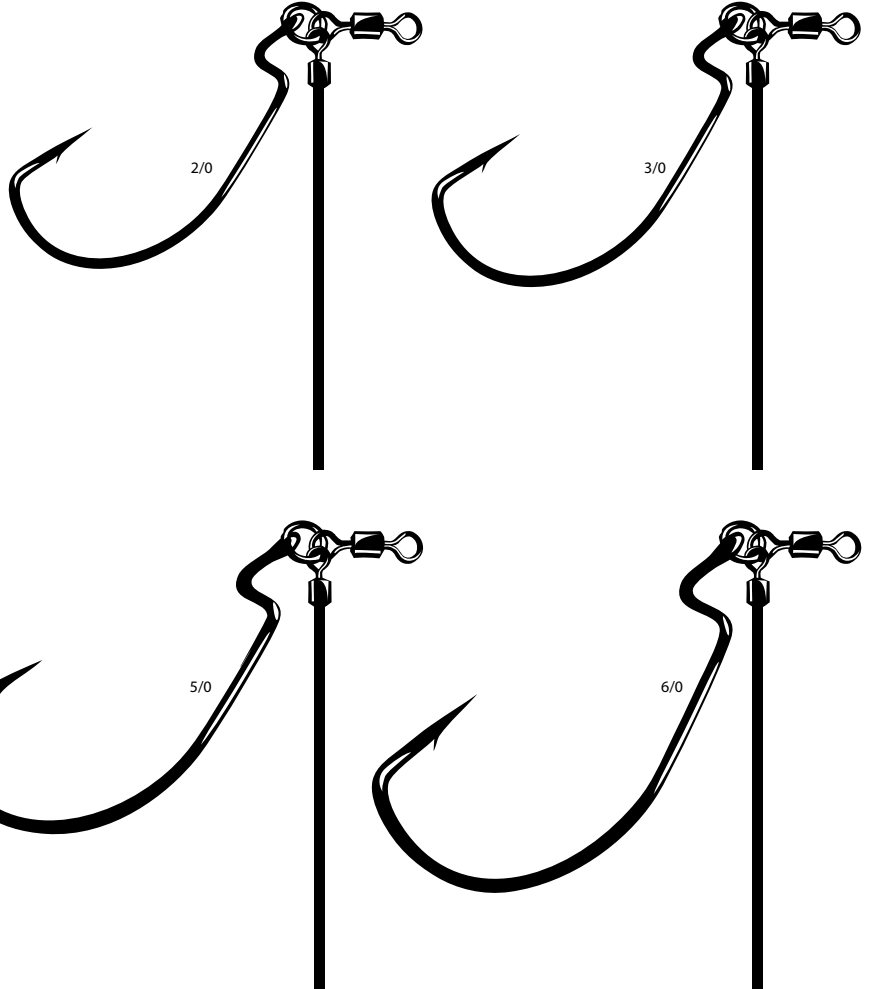

Power Drop with Hybrid Worm

The Power Drop series is uniquely built around a solid ring that connects the premium hook, swivel and a 3.5-inch dropper wire. The G-Finesse Hybrid Worm's unique feature here is the distinctive acute hook angle, designed to align baits perfectly. It features the G-Finesse Hybrid Worm 3622XX series hooks. The premium Gamakatsu swivel completes each rig to prevent line twists. Simply add the desired weight to the dropper wire then bend the end of the shaft with a pair of needle nose pliers to secure in place.

| SIZES | 2/0 | 3/0 | 4/0 | 5/0 | 6/0 | 7/0 | 8/0 |
|-------------|-----------|-----------|-----------|-----------|-----------|-----------|-----------|
| NS Black LS | 401212(2) | 401213(2) | 401214(2) | 401215(2) | 401216(2) | 401217(2) | 401218(2) |

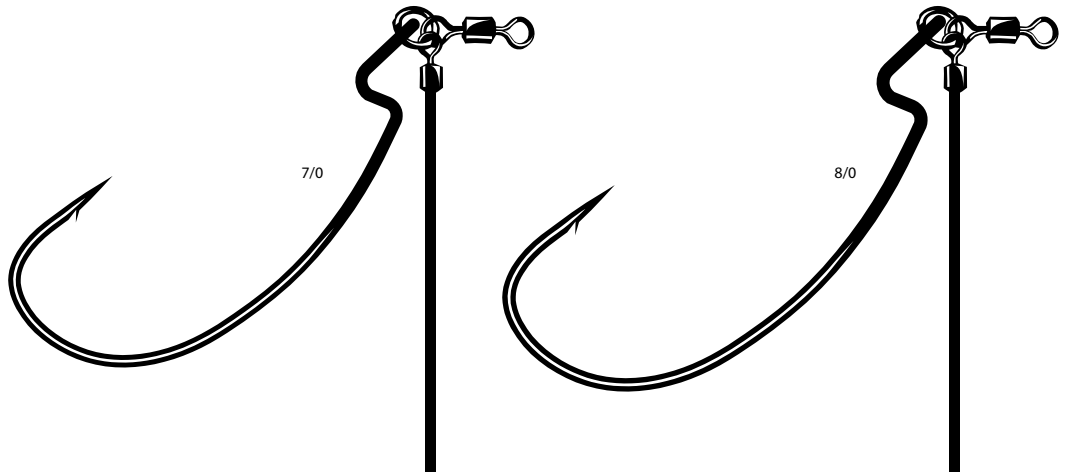
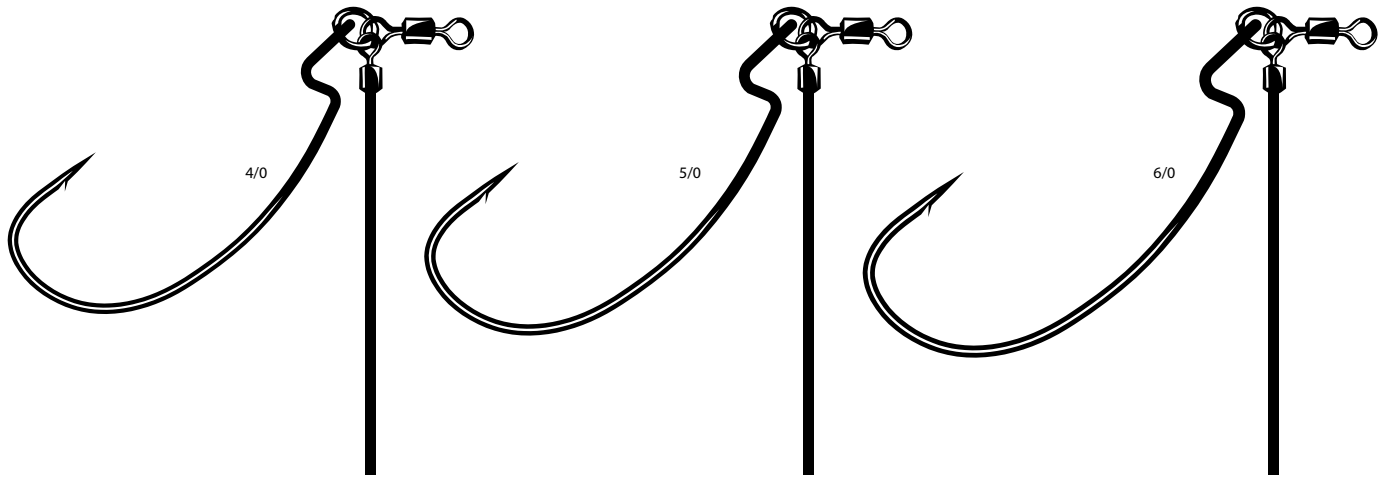
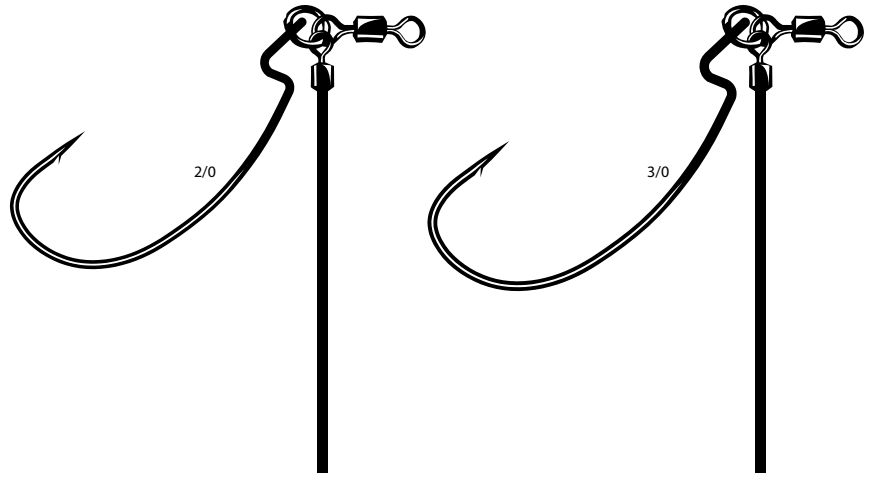

Power Drop with Superline Round Bend

The Power Drop series is uniquely built around a solid ring that connects the premium hook, swivel and a 3.5-inch dropper wire. The Superline Offset Round option offers a larger bite area that's perfect for any worm presentation. It features the Superline Round Bend 3984XX series hooks. The premium Gamakatsu swivel completes each rig to prevent line twists. Simply add the desired weight to the dropper wire then bend the end of the shaft with a pair of needle nose pliers to secure in place.

| SIZES | | 2/0 | 3/0 | 4/0 | 5/0 | 6/0 |
|----------|----|-----------|-----------|-----------|-----------|-----------|
| NS Black | LS | 403412(2) | 403413(2) | 403414(2) | 403415(2) | 402416(2) |



SuperLine

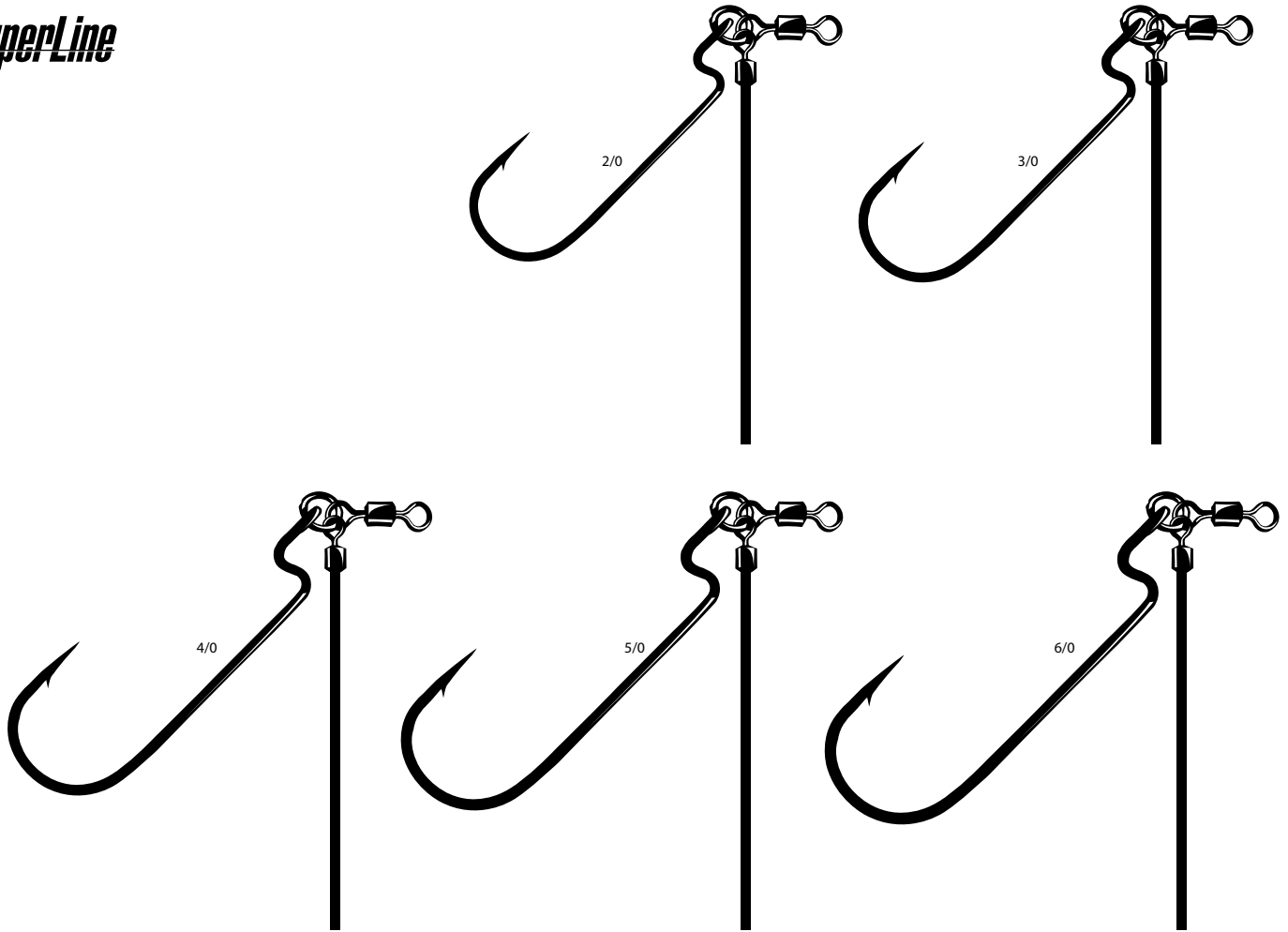



Gammakatsu



JDM

Spinnakatsu[®]

King Cobra Jig

The JDM King Cobra Jig is built around our Gamakatsu 60-degree Nano Alpha hook, which offers plenty of gap width combined with a shorter shank, giving it a compact look. A matte finish, chip resistant painted head in a “Cobra Shape” allows the jig to stand up in a natural defensive posture and prevents the jig from rolling over. Add a hand tied, high contrast skirt, and this jig is about as realistic as you can get. No detail was overlooked in the design of this high quality JDM jig which features a dual wire keeper for plastic trailers, thicker weed guard to prevent snags, and a recessed line tie.

| Sizes | 2/0 | 3/0 | 3/0 | 3/0 | 4/0 |
|--------------------------|--------------------|--------------------|--------------------|--------------------|--------------------|
| Weight | 3/16 | 1/4 | 3/8 | 1/2 | 3/4 |
| Black Blue | 466212-BB-3/16(1) | 466213-BB-1/4(1) | 466213-BB-3/8(1) | 466213-BB-1/2(1) | 466214-BB-3/4(1) |
| Dark Pumpkin | 466212-DP-3/16(1) | 466213-DP-1/4(1) | 466213-DP-3/8(1) | 466213-DP-1/2(1) | 466214-DP-3/4(1) |
| Light Pumpkin Pepper | 466212-LPP-3/16(1) | 466213-LPP-1/4(1) | 466213-LPP-3/8(1) | 466213-LPP-1/2(1) | 466214-LPP-3/4(1) |
| Junebug Black Blue | 466212-JBB-3/16(1) | 466213-JBB-1/4(1) | 466213-JBB-3/8(1) | 466213-JBB-1/2(1) | 466214-JBB-3/4(1) |
| Dark Pumpkin Green | 466212-DPG-3/16(1) | 466213-DPG-1/4(1) | 466213-DPG-3/8(1) | 466213-DPG-1/2(1) | 466214-DPG-3/4(1) |
| Green Pumpkin Black Blue | 466212-GPBB3/16(1) | 466213-GPBB-1/4(1) | 466213-GPBB-3/8(1) | 466213-GPBB-1/2(1) | 466214-GPBB-3/4(1) |



EYE



FORGED



BARB

NANO ALPHA

Black Blue



Dark Pumpkin



Light Pumpkin Pepper



Junebug Black Blue



Dark Pumpkin Green



Green Pumpkin Black Blue



Swimming Shot Neo Swim Jig

The JDM Swimming Shot Neo Swim Jig is second to none when it comes to detail and quality. Built around the ultra-sharp 30-degree Nano Alpha Hook, this swim jig features a slightly longer shank which increases hook ups on short strikes. The head design minimizes hang ups, is chip resistant, and painted in a matte finish. An 8-strand weed guard matches this swim jig allowing it to slip through cover with ease and includes a dual wire keeper for plastic trailers.

| Sizes | 4/0 | 4/0 | 4/0 |
|---------------|-------------------|-------------------|-------------------|
| Weight | 1/4 | 3/8 | 1/2 |
| Watermelon | 467214-WM-1/4(1) | 467214-WM-3/8(1) | 467214-WM-1/2(1) |
| Silver Shad | 467214-SLS-1/4(1) | 467214-SLS-3/8(1) | 467214-SLS-1/2(1) |
| Sexy Shad | 467214-SXS-1/4(1) | 467214-SXS-3/8(1) | 467214-SXS-1/2(1) |
| Ayu | 467214-AYU-1/4(1) | 467214-AYU-3/8(1) | 467214-AYU-1/2(1) |
| Guripan Blue | 467214-GB-1/4(1) | 467214-GB-3/8(1) | 467214-GB-1/2(1) |
| Electric Shad | 467214-ES-1/4(1) | 467214-ES-3/8(1) | 467214-ES-1/2(1) |



EYE



FORGED



BARB

NANO ALPHA

Watermelon



Silver Shad



Sexy Shad



Ayu



Guripan Blue



Electric Shad





TACO

BIG BITE

MERCURY Pro Team

The Strength To Guarantee Your Confidence
SUNLINE

TN 6917 DZ

MINN KOTA

Gunkle







JIG HOOKS

Spinnakatsu[®]

Jig 30° Extra Wide Gap (EWG)

Designed for a wide variety of popular techniques, emerging trends, and do-it-yourself lead jig head pouring. The 30° hook eye angle compliments the 60° and 90° jig hooks that have been the standard for decades. This extra wide gap (EWG) will handle larger baits too. The points are incredibly sticky-sharp right out of the package. Fits most 30° lead molds

| SIZES | | 3/0 | 4/0 | 5/0 | 6/0 | 7/0 |
|----------|-----|------------|------------|------------|------------|------------|
| NS Black | 25 | 382413-25 | 382414-25 | 382415-25 | 382416-25 | 382417-25 |
| | 100 | 382413-100 | 382414-100 | 382415-100 | 382416-100 | 382417-100 |

-  EYE
-  FORGED
-  BARB
-  EWG - EXTRA WIDE GAP

SuperLine

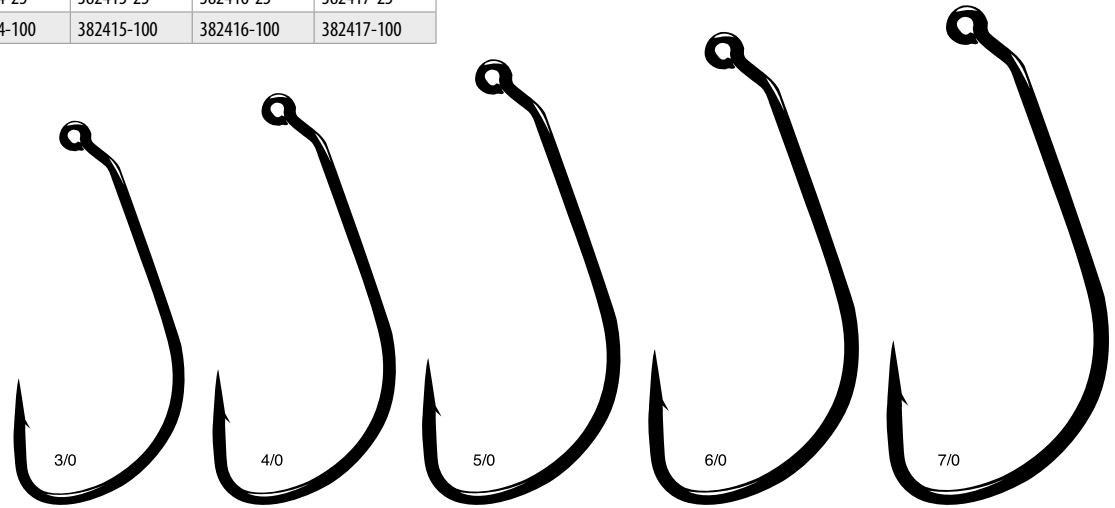

Jig 60° Round Bend

The Jig 60 Round Bend hook delivers in terms of both simplicity and function for anglers and is now available in our popular NS Black (nickel silver black) color. The 60-degree round bend design makes this a go-to jig hook for flipping and pitching. The bite area is fantastic, helping anglers connect on difficult hooksets. Adding the NS Black color gives DIY anglers more options when pouring their own jigs

| SIZES | | 2/0 | 3/0 | 4/0 | 5/0 |
|----------|-----|-----------|-----------|-----------|-----------|
| NS Black | 25 | 29412-25 | 29413-25 | 29414-25 | 29415-25 |
| | 100 | 29412-100 | 29413-100 | 29414-100 | 29415-100 |

-  EYE
-  FORGED
-  BARB

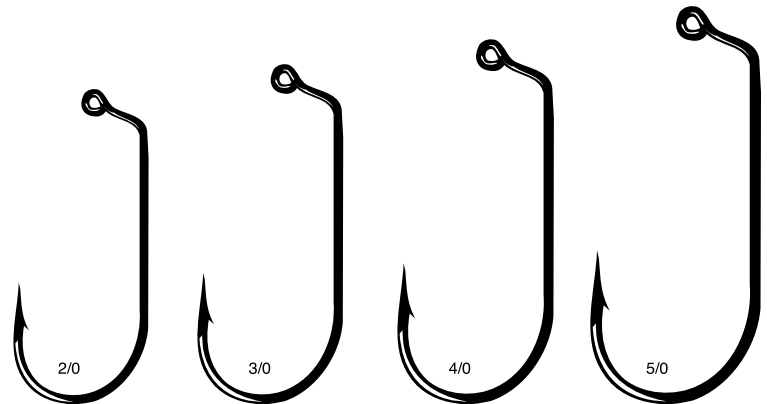

Jig 60° Flat Eye, Light Wire, Round Bend

A light wire version for those finesse applications and lighter jigs.

| SIZES | | 3/0 | 4/0 | 5/0 |
|----------|-----|-----------|-----------|-----------|
| NS Black | 25 | 61413-25 | 61414-25 | 61415-25 |
| | 100 | 61413-100 | 61414-100 | 61415-100 |

-  EYE
-  FORGED
-  BARB

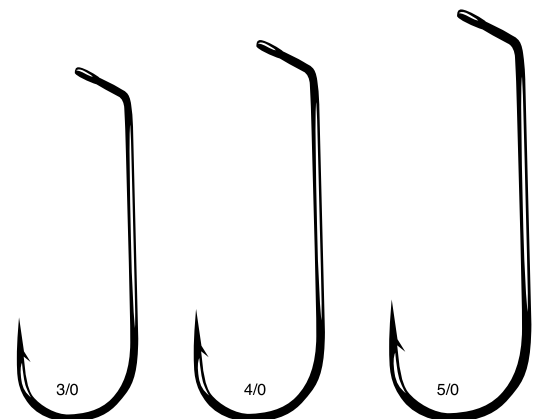

Jig 60° Flat Eye, Round Bend

A heavy wire hook in a corrosion resistant NS Black finish for use in fresh or saltwater.

| SIZES | | 2/0 | 3/0 | 4/0 | 5/0 |
|----------|-----|-----------|-----------|-----------|-----------|
| NS Black | 25 | 59412-25 | 59413-25 | 59414-25 | 59415-25 |
| | 100 | 59412-100 | 59413-100 | 59414-100 | 59415-100 |

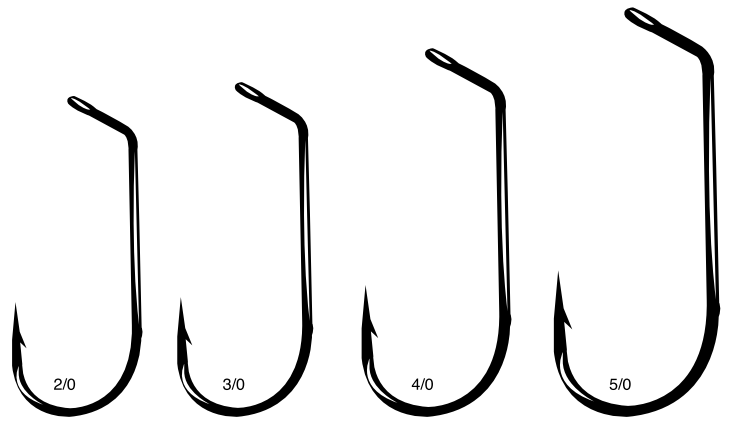

Jig 60° Extra Wide Gap (EWG)

Designed with an extra wide gap for the larger bodied plastics and skirts. The extra wide gap gives you more surface area for better hook ups.

| SIZES | | 3/0 | 4/0 |
|----------|-----|------------|------------|
| NS Black | 25 | 201413-25 | 201414-25 |
| | 100 | 201413-100 | 201414-100 |

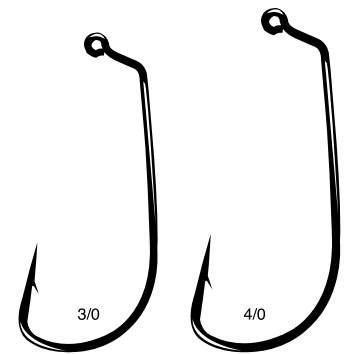

Jig 90° Round Bend

| SIZES | | 2 | 1 | 1/0 | 2/0 | 3/0 | 4/0 | 5/0 |
|----------|-----|-----------|-----------|-----------|-----------|-----------|-----------|-----------|
| NS Black | 25 | 11409-25 | 11410-25 | 11411-25 | 11412-25 | 11413-25 | 11414-25 | 11415-25 |
| | 100 | 11409-100 | 11410-100 | 11411-100 | 11412-100 | 11413-100 | 11414-100 | 11415-100 |

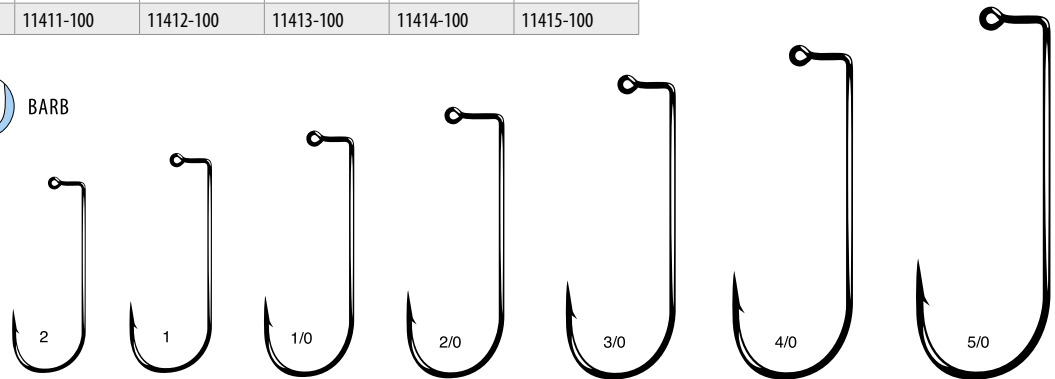

Jig 90° Heavy Wire Round Bend

Our most popular jig hook, and most versatile. Made with a heavy wire and is saltwater ready.

| SIZES | | 2 | 1 | 1/0 | 2/0 | 3/0 | 4/0 | 5/0 | 6/0 | 7/0 | 8/0 |
|------------|-----|-----------|-----------|-----------|-----------|-----------|-----------|-----------|-----------|-----------|-----------|
| NS Black | 25 | 60409-25 | 60410-25 | 60411-25 | 60412-25 | 60413-25 | 60414-25 | 60415-25 | 60416-25 | 60417- 25 | 60418- 25 |
| | 50 | | | | | | | | | 60417- 50 | 60418- 50 |
| | 100 | 60409-100 | 60410-100 | 60411-100 | 60412-100 | 60413-100 | 60414-100 | 60415-100 | 60416-100 | | |
| Nano Alpha | 25 | 60209-25 | 60210-25 | 60211-25 | 60212-25 | 60213-25 | 60214-25 | 60215-25 | | | |



NANO ALPHA

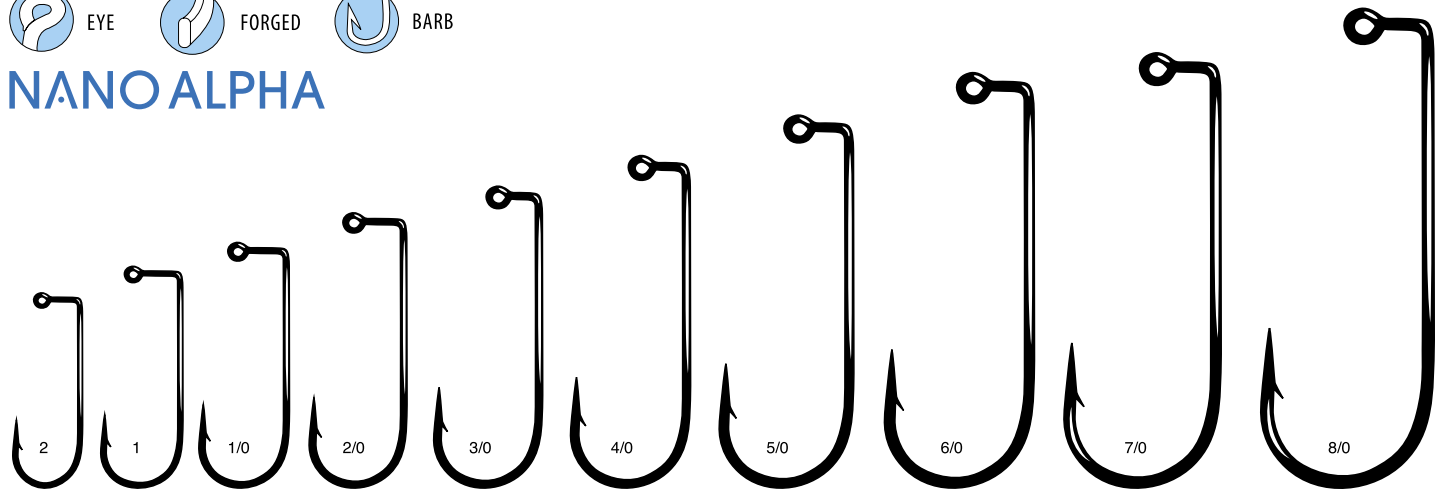

Jig 90° Salty HD

In the saltwater world, few jig hooks are built to withstand the hardest fighting fish in the ocean. Hard strikes and wild runs from species like striped bass will test the strength of any hook. The Jig 90 Salty HD is specially made with O'Shaughnessy bend and heavy wire that can hold form against the toughest fish out there. The Jig 90 Salty HD is forged for strength and the NS Black (nickel silver black) coating resists corrosion.

| SIZES | | 6/0 | 7/0 | 8/0 |
|----------|----|-----------|-----------|-----------|
| NS Black | 25 | 223416-25 | 223417-25 | 223418-25 |

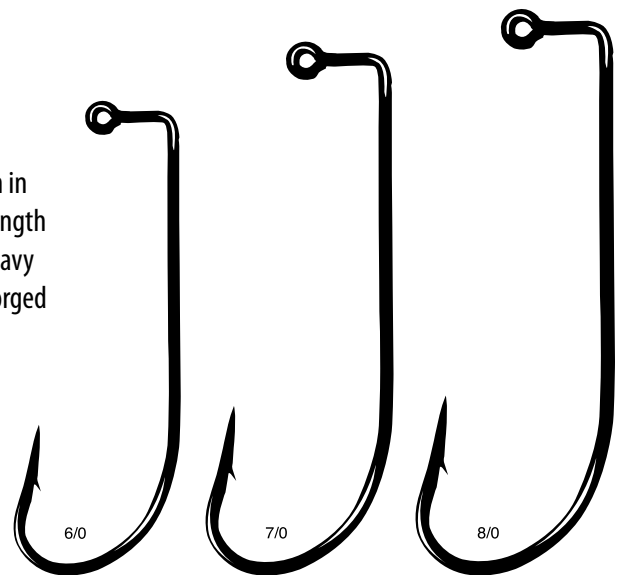

Jig 90° Big River

The Jig 90 Big River will quickly become a staple for anglers desiring a versatile jig hook capable of performing in different environments and for a variety of species. The large gap and acute bend offer great holding power, locking fish in place when hooked. DIY anglers will like the longer shank to pour heavier jig heads on. This unique design comes in a wide range of sizes for fisherman, targeting everything from steelhead to walleye.

| SIZES | | 2 | 1 | 1/0 | 2/0 | 3/0 | 4/0 |
|----------|-----|------------|------------|------------|------------|------------|------------|
| NS Black | 25 | 412409-25 | 412410-25 | 412411-25 | 412412-25 | 412413-25 | 412414-25 |
| | 100 | 412409-100 | 412410-100 | 412411-100 | 412412-100 | 412413-100 | 412414-100 |



EYE



FORGED



BARB

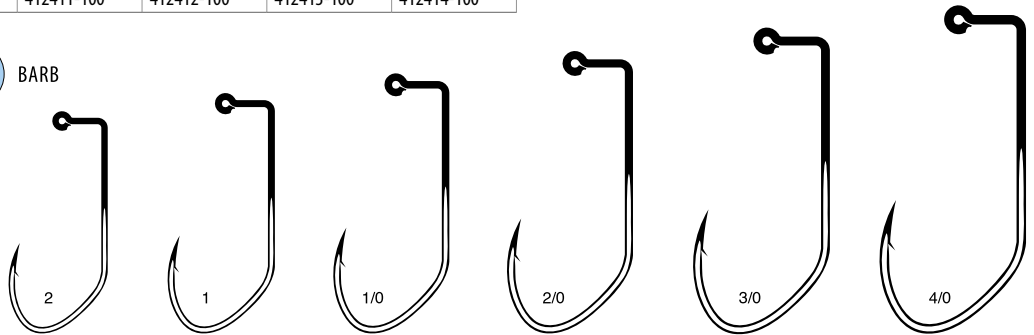

Jig 90° Big River HD

The Jig 90 Big River HD was developed for the DIY jig maker looking for a 2x strong version of the original BR 90 jig hook. The HD version has a couple of improvements over the original design. having a 2x stronger wire over the original design. Plus, it has the Nano Alpha finish to enhance its corrosion resistance, and aid in hook penetration. The HD version will become a Salmon and Steelhead fisherman's dream come true knowing they have a 2x stronger hook!

| Sizes | | 1/0 | 2/0 | 3/0 | 4/0 |
|------------|-----|------------|------------|------------|------------|
| Nano Alpha | 25 | 474211-25 | 474212-25 | 474213-25 | 474214-25 |
| | 100 | 474211-100 | 474212-100 | 474213-100 | 474214-100 |



EYE



FORGED



BARB

NANO ALPHA

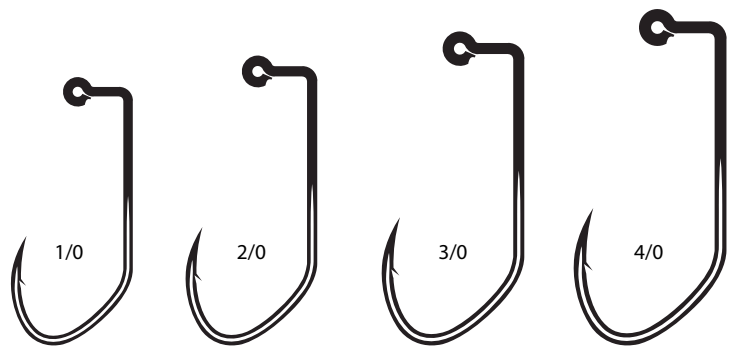

tsu[®]





JIG HEADS

Spinnaker[®]

Spring Lock Spinner

The new Spring Lock Spinner from Gamakatsu makes your favorite swimbaits and other soft plastics even more effective by adding flash and vibration to attract fish from even greater distances. The revolutionary design features two retaining wires wound in parallel, making rigging simple and providing even more holding power, so baits won't slip no matter how hard you fish. The new rigging system has innovative features that draw strikes from pressured fish and is built on a premium 2x strong hook to handle the biggest predators. Combining the 28-degree hook eye and premium spring lock allows you to keep your bait in place, so it runs true every cast.

| SIZES | 3/0-3/16 | 5/0-1/4 | 6/0-3/8 | 7/0-3/8 | 9/0-3/8 | 10/0-1/2 | 12/0-3/4 |
|----------|----------------|---------------|---------------|---------------|---------------|---------------|---------------|
| NS Black | 404413-3/16(1) | 404415-1/4(1) | 404416-3/8(1) | 404417-3/8(1) | 404419-3/8(1) | 404420-1/2(1) | 404422-3/4(1) |

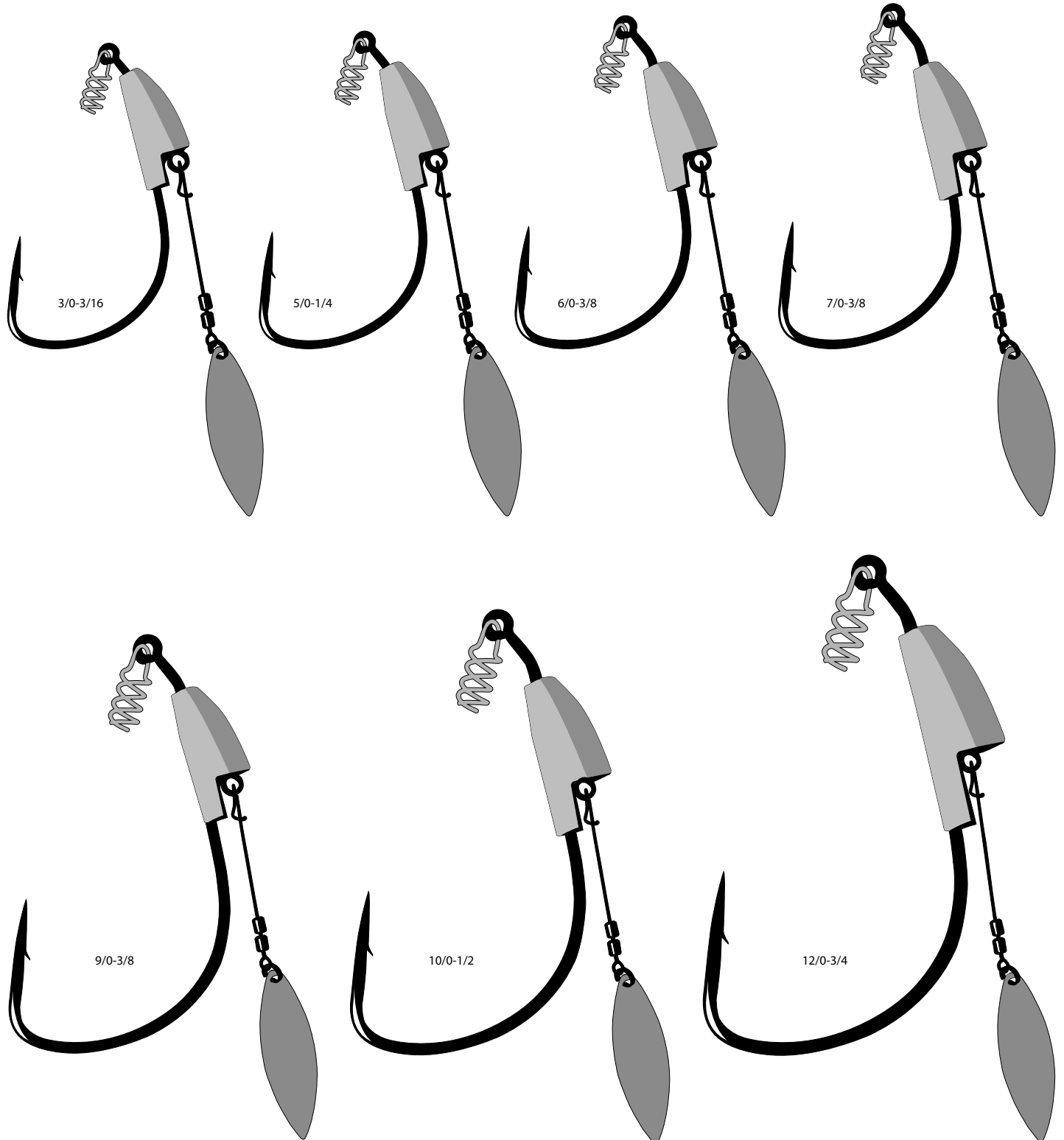

Under Spin Head Mini

The Under Spin Head Mini features Gamakatsu's premium size 1 Finesse Heavy Cover 60-degree hook, the wide gap design means you can still rig bulkier plastics and have plenty of bite. Ideal for smaller finesse presentations, the head profile is streamlined to glide through cover. Attention-getting recessed lifelike eyes and the small chrome willow leaf blade result in a combination that fish can't resist. Gamakatsu's Spring Lock holds swim baits and other plastics gently but firmly, keeping the presentation straight on the hook.

| SIZES | 1-1/8 | 1-3/16 | 1-1/4 | 1-1-3/8 |
|----------|---------------|----------------|---------------|---------------|
| NS Black | 435410-1/8(1) | 435410-3/16(1) | 435410-1/4(1) | 435410-3/8(1) |

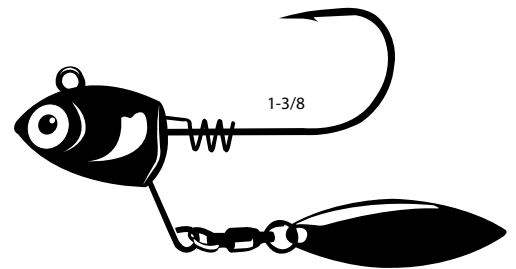
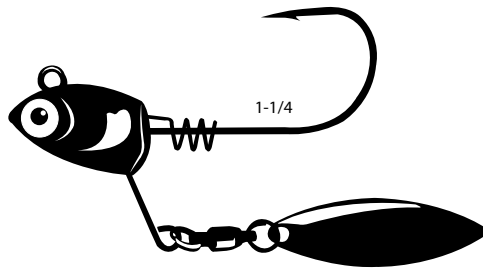
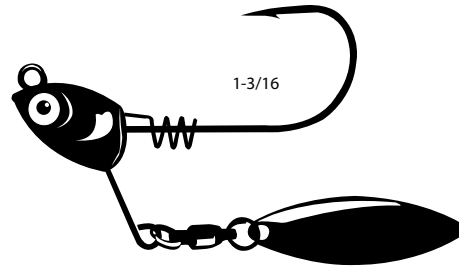
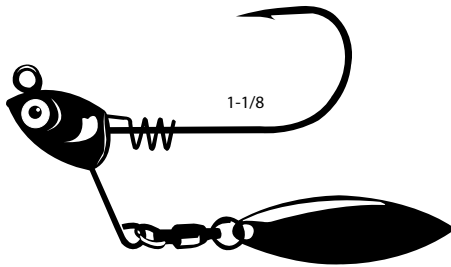

Under Spin Head

The Under Spin Head features Gamakatsu Heavy Cover 60-degree hook. The heavy wire and wide gap design of the Heavy Cover gives anglers a better hook up ratio and retention when using bulky swim baits. Ideal for heavy braid or fluorocarbon line. The head profile is streamlined to glide through cover. Gamakatsu Spring Lock holds swim baits and other plastics gently but firmly, keeping your presentation straight on the hook. Recessed lifelike eyes on the Under Spin provide a focal point for predators. The small chrome blade is attached to a quality ball-bearing swivel allowing it to spin freely, even at the slowest retrieves, to simulate baitfish and create a subtle trigger.

| SIZES | 4/0-3/16 | 4/0-1/4 | 4/0-3/8 | 4/0-1/2 |
|----------|----------------|---------------|---------------|---------------|
| NS Black | 394414-3/16(1) | 394414-1/4(1) | 394414-3/8(1) | 394414-1/2(1) |

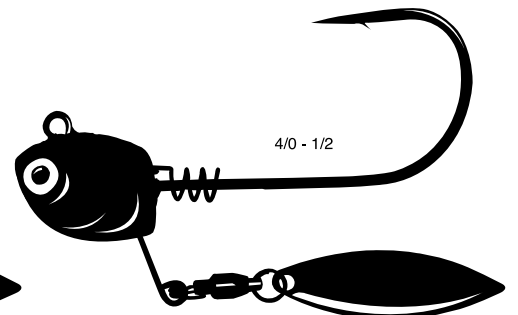
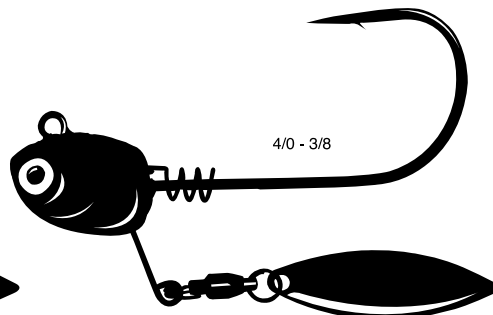
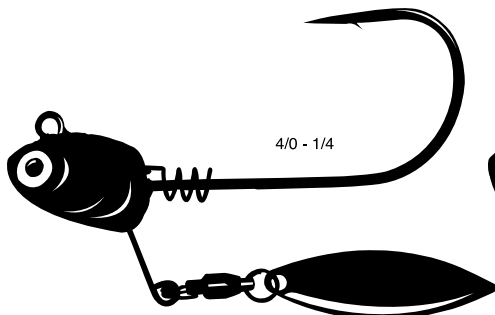
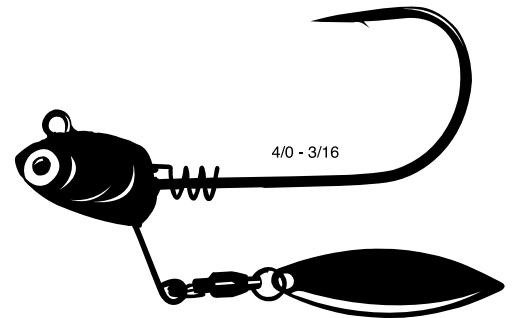

Superline Swim Bait Head

Until now, you simply couldn't find a premium, swim bait jig head with a premium Gamakatsu hook. The new Superline Swim Bait Head changes all that. The head profile is streamlined for a natural action. Choose premium painted heads or unpainted for anglers that prefer a do-it-yourself custom look. A heavy wire, 60-degree Superline hook performs optimally with braided line and heavy monofilament. Completing the package, The Spring Lock keeper holds all soft plastic swim baits secure and tight.

| SIZES | | 4/0 - 1/8 | 4/0 - 3/16 | 4/0 - 1/4 | 5/0 - 3/8 | 5/0 - 1/2 |
|-------------|----|------------------|-------------------|------------------|------------------|------------------|
| Clear | LS | 353414-1/8(3) | 353414-3/16(3) | 353414-1/4(3) | 353415-3/8(3) | 353415-1/2(3) |
| Pearl White | LS | 353414-PW-1/8(3) | 353414-PW-3/16(3) | 353414-PW-1/4(3) | 353415-PW-3/8(3) | 353415-PW-1/2(3) |



SuperLine

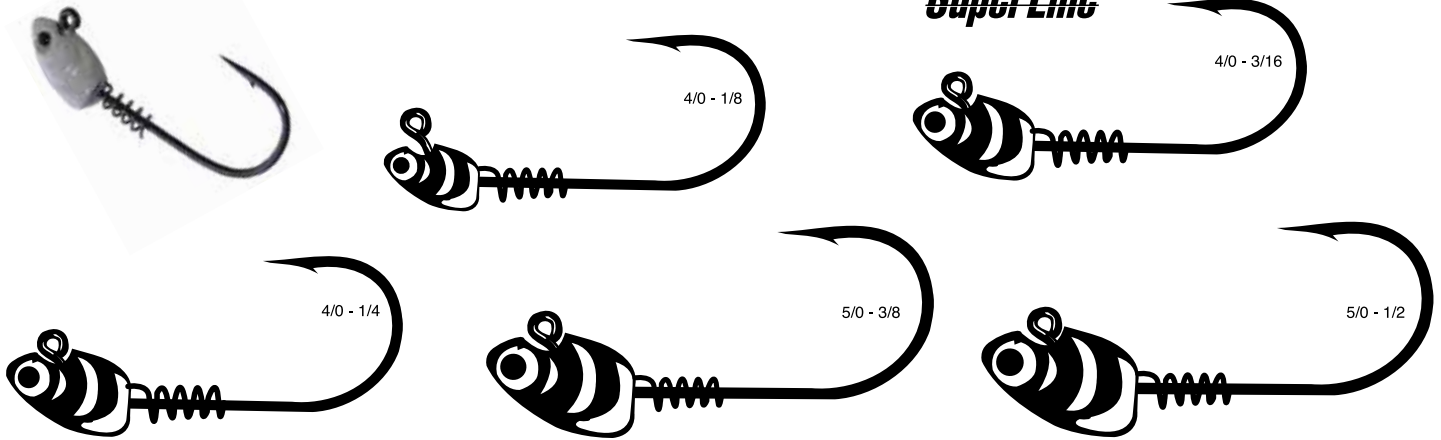

Stand Up Alien Head

Looking for the quintessential stand-up jig head? Gamakatsu's developed the answer with its all-new Stand-Up Alien Head. Perfect for rock or hard bottom fishing, The innovative keeper pin holds plastics without tearing. The benefit is a better presentation, more casts and more mileage out of your plastics. Features a NS Black finesse hook and is available in Green Pumpkin and Black jig heads.

| SIZES | | 3/0-1/8 | 3/0-3/16 | 3/0-1/4 | 3/0-5/16 |
|---------------|--|------------------|-------------------|------------------|-------------------|
| Black | | 309413-BK-1/8(4) | 309413-BK-3/16(4) | 309413-BK-1/4(4) | 309413-BK-5/16(4) |
| Green Pumpkin | | 309413-GP-1/8(4) | 309413-GP-3/16(4) | 309413-GP-1/4(4) | 309413-GP-5/16(4) |

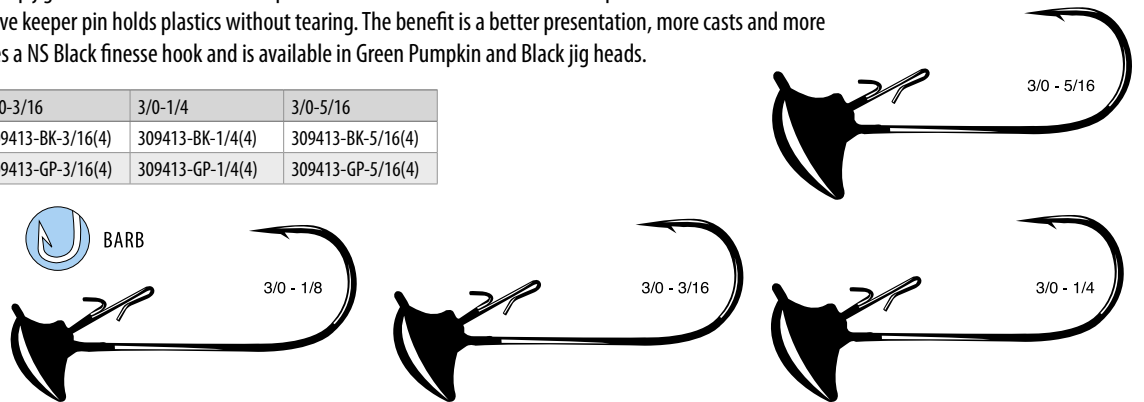

Horizon Head

The Horizon Head was designed with the weight distributed on the shank of the hook which creates a horizontal profile when rigged with a soft plastic to simulate a realistic baitfish appearance when swimming or falling. It has a Gamakatsu round bend jig hook with Nano Alpha finish.

| Sizes | | 1/0 | 1/0 | 1/0 | 2/0 | 2/0 | 2/0 | 3/0 | 3/0 |
|------------|----|----------------|----------------|----------------|----------------|----------------|----------------|----------------|----------------|
| Weight | LS | 3/64 | 1/16 | 3/32 | 3/64 | 1/16 | 3/32 | 3/64 | 1/16 |
| Nano Alpha | | 465211-3/64(4) | 465211-1/16(4) | 465211-3/32(4) | 465212-3/64(4) | 465212-1/16(4) | 465212-3/32(4) | 465213-3/64(4) | 465213-1/16(4) |



NANO ALPHA

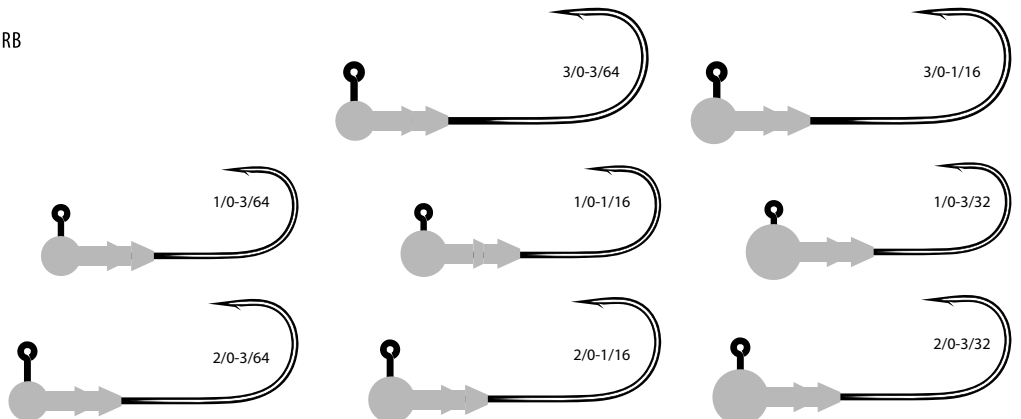

Horizon Head SN

Our new Horizon Head SN is designed to maintain a horizontal posture while imparting an extremely natural action to your bait. The Horizon Head SN weighs in at 1/96 oz, making it the perfect choice for those super tough conditions when you need the most natural action possible on your bait. This head also features a Nano Alpha coating which assists in corrosion resistance and comes equipped with an ultra-sharp Gamakatsu hook.

| Sizes | | 2 | 1 | 1/0 | 2/0 | 3/0 |
|------------|----|----------------|----------------|----------------|----------------|----------------|
| Weight | LS | 1/96 | 1/96 | 1/96 | 1/96 | 1/96 |
| Nano Alpha | | 475209-1/96(4) | 475210-1/96(4) | 475211-1/96(4) | 475212-1/96(4) | 475213-1/96(4) |



NANO ALPHA

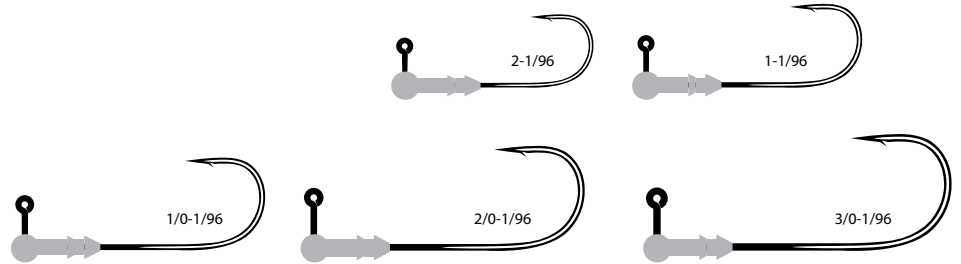

Horizon Head LG

The Horizon Head LG was designed for mid and deep strolling and features a Tournament Grade Wire (TGW) hook with Nano Alpha finish. Like the original Horizon Head, it also features a unique, elongated keeper which promotes a balanced horizontal presentation when retrieved or falling. The LG version features a larger gap hook with a focus on the hook tip angle and a center of gravity to produce a rolling action on the retrieve.

| Sizes | | 1/0 | 1/0 | 1/0 | 2/0 | 2/0 | 2/0 | 2/0 | 3/0 | 3/0 | 3/0 | 3/0 |
|------------|----|---------------|----------------|----------------|---------------|----------------|----------------|---------------|---------------|----------------|----------------|---------------|
| Weight | LS | 1/8 | 5/32 | 3/16 | 1/8 | 5/32 | 3/16 | 1/5 | 1/8 | 5/32 | 3/16 | 1/5 |
| Nano Alpha | | 469211-1/8(4) | 469211-5/32(4) | 469211-3/16(4) | 469212-1/8(4) | 469212-5/32(4) | 469212-3/16(4) | 469212-1/5(4) | 469213-1/8(4) | 469213-5/32(4) | 469213-3/16(4) | 469213-1/5(4) |



NANO ALPHA



Tournament Grade Wire

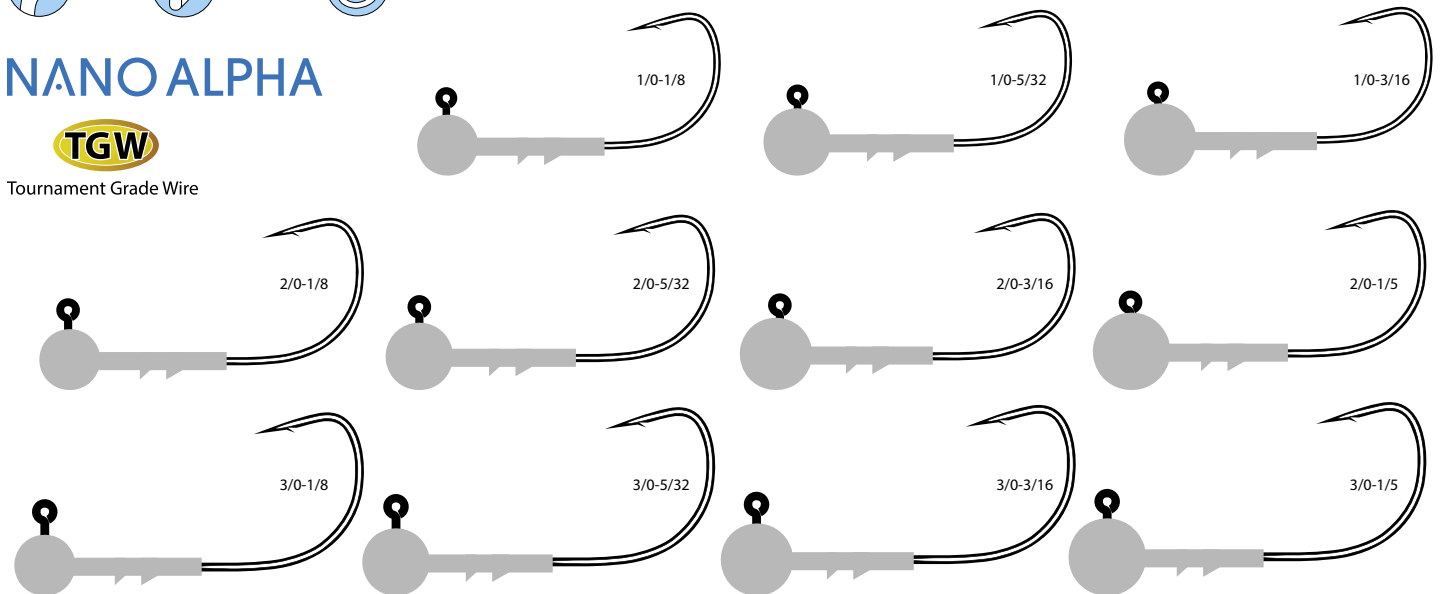

Horizon Head LG Weedless

The Horizon Head LG Weedless has an added weedguard for fishing around cover. It features the larger gap Tournament Grade Wire (TGW) Nano Alpha LG hook. This weedless version has a titanium weedguard molded in the head to help prevent snags, while not impacting hooking ratios.

| Sizes | | 1/0 | 1/0 | 1/0 | 2/0 | 2/0 | 2/0 | 2/0 | 3/0 | 3/0 | 3/0 | 3/0 |
|------------|----|---------------|----------------|----------------|---------------|----------------|----------------|---------------|---------------|----------------|----------------|---------------|
| Weight | LS | 1/8 | 5/32 | 3/16 | 1/8 | 5/32 | 3/16 | 1/5 | 1/8 | 5/32 | 3/16 | 1/5 |
| Nano Alpha | | 470211-1/8(4) | 470211-5/32(4) | 470211-3/16(4) | 470212-1/8(4) | 470212-5/32(4) | 470212-3/16(4) | 470212-1/5(4) | 470213-1/8(4) | 470213-5/32(4) | 470213-3/16(4) | 470213-1/5(4) |



NANO ALPHA



Tournament Grade Wire

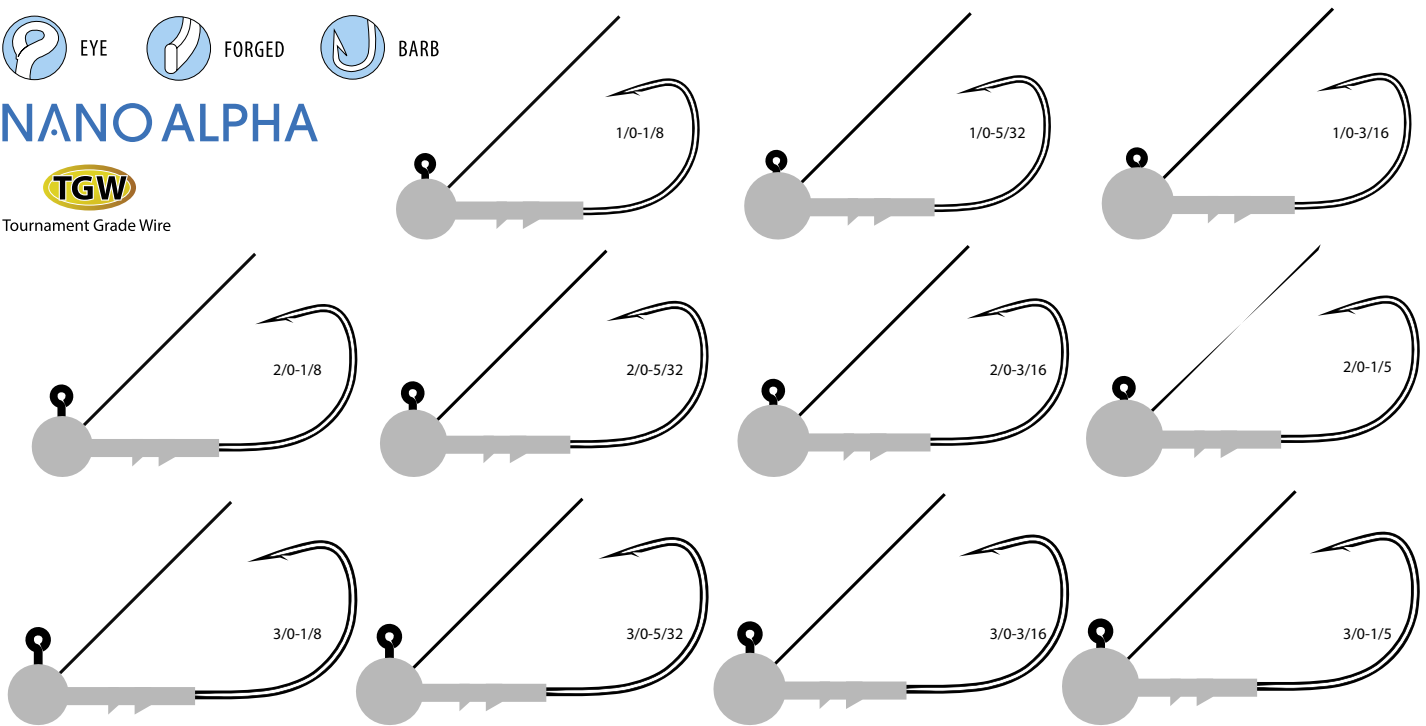

Horizon Head LG Weedless Light

Perfect for finesse applications, the Horizon Head LG Weedless Light offers a finesse version of the original Horizon Head design, ideal for mid-strolling and shallow water fishing. Crafted with Tournament Grade Wire (TGW), Nano Alpha, and an LG (Large Gap) design, this head also features a titanium weed guard for optimal weedless performance. A highly effective pre-spawn search tool, particularly when lighter weights and finesse plastics are required.

| Sizes | | 2 | 2 | 2 | 2 | 1 | 1 | 1 | 1 | 1/0 | 1/0 | 1/0 | 1/0 |
|------------|----|----------------|----------------|----------------|----------------|----------------|----------------|----------------|----------------|----------------|----------------|----------------|----------------|
| Weight | LS | 1/32 | 3/64 | 1/16 | 3/32 | 1/32 | 3/64 | 1/16 | 3/32 | 1/32 | 3/64 | 1/16 | 3/32 |
| Nano Alpha | | 482209-1/32(4) | 482209-3/64(4) | 482209-1/16(4) | 482209-3/32(4) | 482210-1/32(4) | 482210-3/64(4) | 482210-1/16(4) | 482210-3/32(4) | 482211-1/32(4) | 482211-3/64(4) | 482211-1/16(4) | 482211-3/32(4) |



NANO ALPHA



Tournament Grade Wire

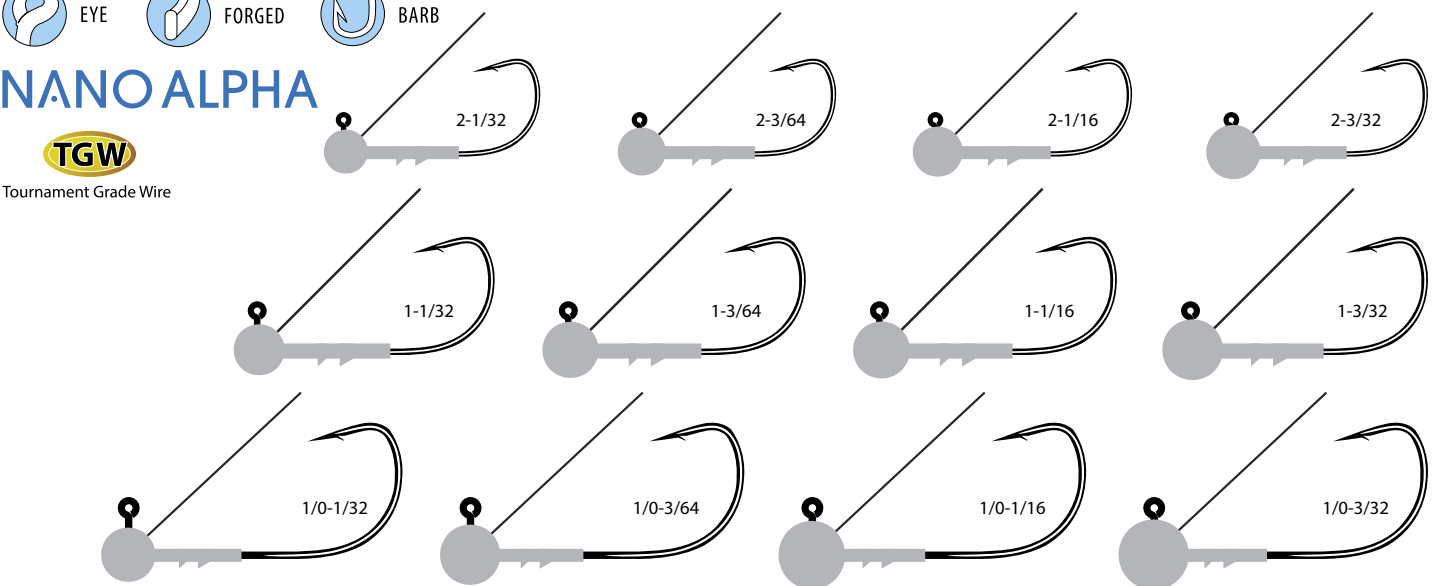

Finesse Jig Head

When new tournament techniques emerge, our pro-staff are usually holding the rod. Case in point, the Finesse Jig Head is designed to optimize the “Ned Rig.” It’s all about precise positioning of small soft plastics in a manner that translates into that slow, gliding fall that big bass can’t resist. The spring keeper and size #1 hook are critical features. Lead heads are unpainted allowing for easy customization.

| SIZES | | 1 | 1 | 1 |
|--------|----|----------------|----------------|---------------|
| WEIGHT | LS | 1/16 | 3/32 | 1/8 |
| | | 506410-1/16(4) | 506410-3/32(4) | 506410-1/8(4) |

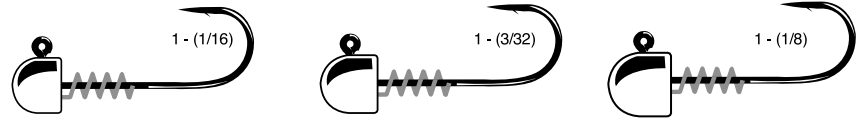

Finesse Jig Head EWG

If you’re familiar with the Ned rig technique, you probably haven’t seen this before: An offset eye, countersunk into the jig head, with a premium forged steel Gamakatsu hook. Well, now you have. Reduce time rigging and spend more time fishing. This all-in-one design is tough to beat when bass are spooked or finicky in overfished conditions.

| SIZES | | 1/0 | 1/0 | 1/0 | 1/0 |
|--------|----|----------------|---------------|----------------|---------------|
| WEIGHT | LS | 3/32 | 1/8 | 3/16 | 1/4 |
| | | 386411-3/32(4) | 386411-1/8(4) | 386411-3/16(4) | 386411-1/4(4) |

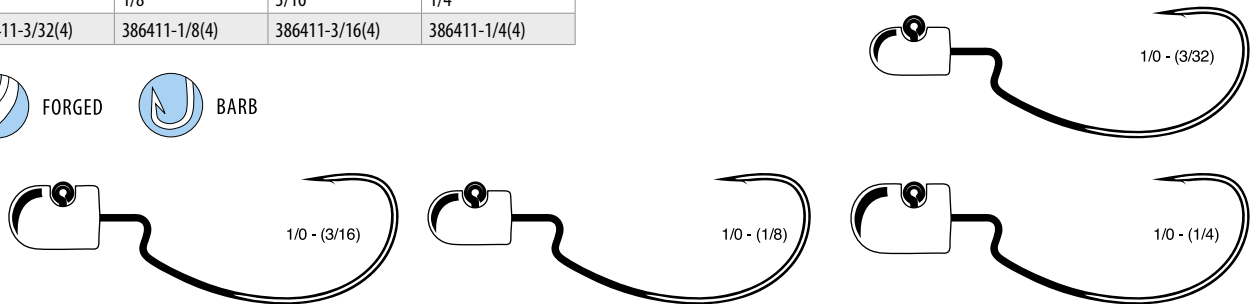

Bottom Knocker Offset

Anglers on the other side of the “big pond” have been boasting about the advantages of using an offset bottom knocker for many years now. We put them in the hands of several of our most trusted pros and tackle testers in the U.S. and waited to hear what they had to say. What a surprise, they slay bigmouths here in the States as well. Notice the finesse football head designed for fishing deep structure, and the fact that the hook eye is offset to tantalize the “lay down” action. And of course, the genuine Gamakatsu hook is as sharp as they come.

| SIZES | | 1/0 | 1/0 | 1/0 | 1/0 |
|--------|----|---------------|---------------|---------------|---------------|
| WEIGHT | LS | 3/8 | 1/2 | 5/8 | 3/4 |
| | | 383411-3/8(4) | 383411-1/2(4) | 383411-5/8(4) | 383411-3/4(4) |

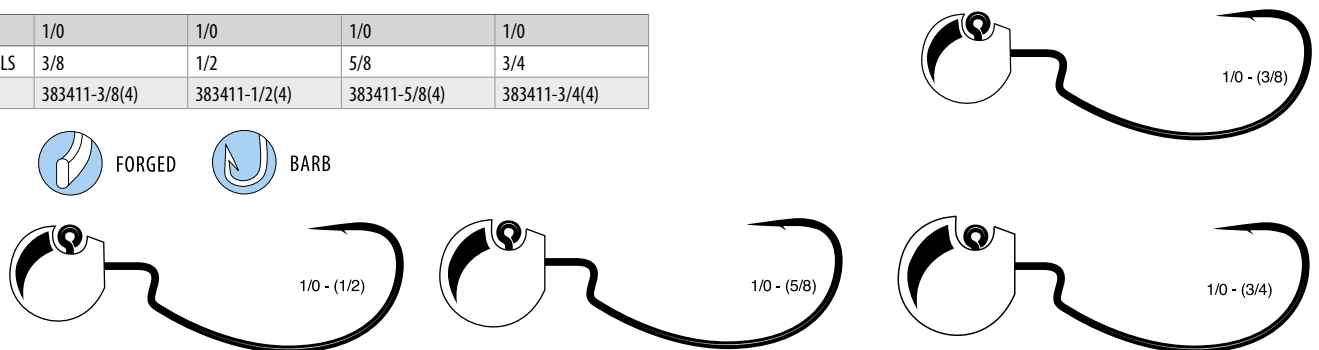

Crappie Jig Head

Designed for tournament focused crappie anglers. This premium design, specialized Crappie Jig Head, features a sticky sharp Gamakatsu hook fully molded through the lead head. The smooth eye won't burr even the lightest line. A heavy-duty spring lock keeper encircles the shank for nearly half its length. Soft plastics won't move a millimeter with this innovation. #2 light wire jig hooks in NS Black.

| SIZES | | 2 | 2 | 2 |
|--------|----|----------------|----------------|---------------|
| WEIGHT | LS | 1/16 | 3/32 | 1/8 |
| | | 507409-1/16(5) | 507409-3/32(5) | 507409-1/8(5) |

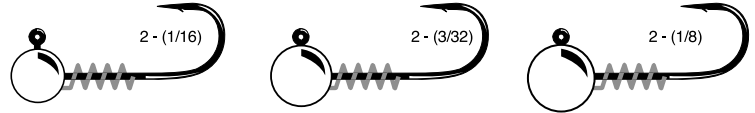

Round 26

The standard round head design makes this a very versatile jig head. It features our 604 series heavy wire jig hook which is very popular with Salmon and Steelhead anglers and also has two keeper type rings behind the head to hold soft plastic baits firmly in place.

| SIZES | | 1/0 | 1/0 | 2/0 | 2/0 | 3/0 | 3/0 |
|--------|----|----------------|---------------|----------------|---------------|----------------|---------------|
| WEIGHT | LS | 1/16 | 1/8 | 3/16 | 1/4 | 3/16 | 1/4 |
| | | 500411-1/16(5) | 500411-1/8(5) | 500412-3/16(5) | 500412-1/4(5) | 500413-3/16(5) | 500413-1/4(5) |

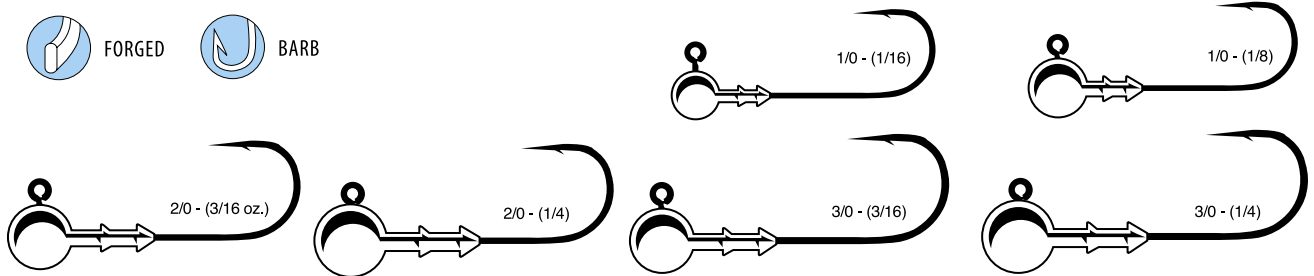

Round 26 Weedless

Like the original Round 26, the weedless version features a standard lead collar, but adds dual offset rebarb wire keepers to securely and firmly hold a wide range of soft plastic baits. It also features a dual-titanium, wire weed guard that will not break, offering the added versatility to fish in and around heavy cover, where the bigger, more elusive lunkers lie.

| SIZES | | 2/0 | 2/0 | 2/0 | 3/0 | 3/0 | 4/0 | 4/0 |
|--------|----|----------------|---------------|---------------|----------------|---------------|---------------|---------------|
| WEIGHT | LS | 1/16 | 1/8 | 3/8 | 3/16 | 1/4 | 3/8 | 1/2 |
| | | 420412-1/16(3) | 420412-1/8(3) | 420412-3/8(3) | 420413-3/16(3) | 420413-1/4(3) | 420414-3/8(3) | 420414-1/2(3) |

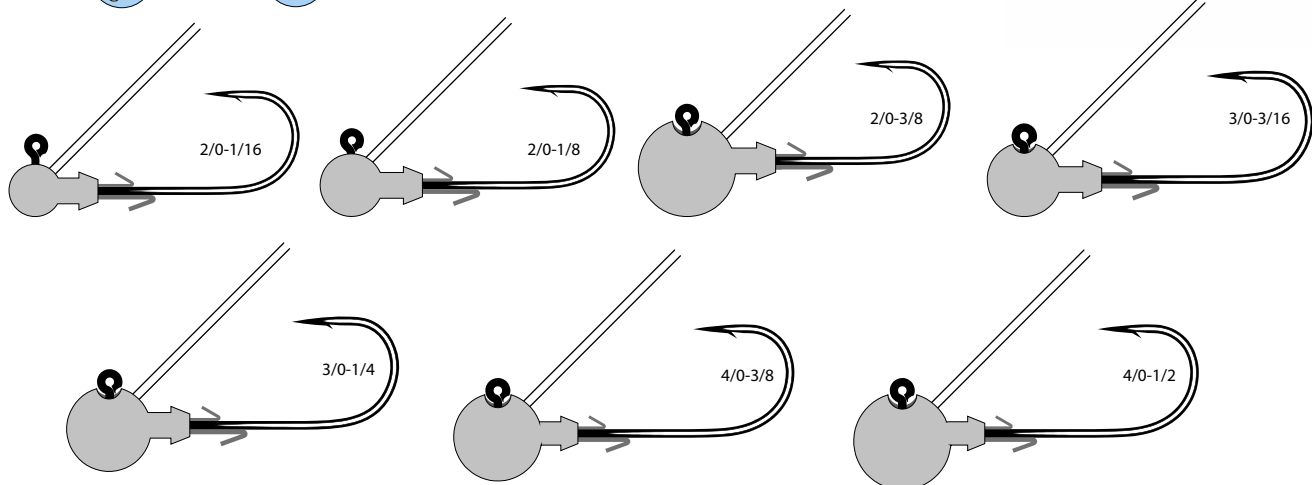

Round 211

A totally unique design with a short shank and a matte black beak point. Great for live and finesse baits.

| SIZES | | 2 | 2 | 2 |
|--------|----|----------------|----------------|---------------|
| WEIGHT | LS | 1/32 | 1/16 | 1/8 |
| | | 501409-1/32(5) | 501409-1/16(5) | 501409-1/8(5) |

| SIZES | | 1 | 1 | 1 |
|--------|----|----------------|----------------|---------------|
| WEIGHT | LS | 1/32 | 1/16 | 1/8 |
| | | 501410-1/32(5) | 501410-1/16(5) | 501410-1/8(5) |



Football 24

The Football 24 is the choice when fishing around rock or ledges. It is designed to be very snag resistant. The 24 is the way to go when dragging a Hula Grub or Beaver on deep structure. The 24 features a fine wire hook for fast penetration.

| SIZES | | 1/0 | 2/0 | 2/0 | 3/0 | 5/0 |
|--------|----|----------------|---------------|---------------|---------------|---------------|
| WEIGHT | LS | 3/16 | 1/4 | 3/8 | 1/2 | 3/4 |
| | | 502411-3/16(5) | 502412-1/4(5) | 502412-3/8(5) | 502413-1/2(5) | 502415-3/4(4) |

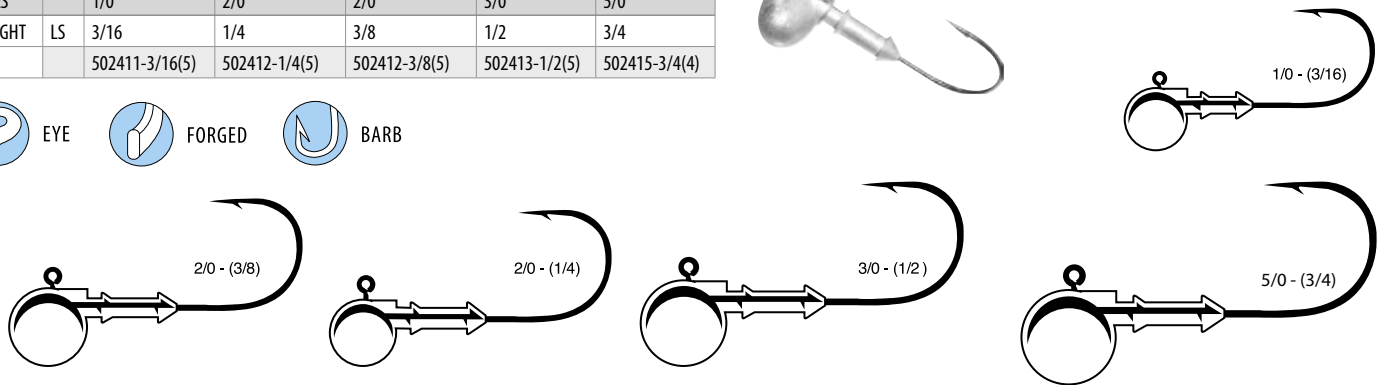

Darter 26

This jig comes with optional nylon brush guards and features a heavy duty 90 degree jig hook. The streamlined head design makes it ideal in both fresh and saltwater applications.

| SIZES | | 2/0 | 2/0 | 3/0 | 3/0 |
|--------|----|---------------|----------------|---------------|---------------|
| WEIGHT | LS | 1/8 | 3/16 | 1/4 | 3/8 |
| | | 505412-1/8(5) | 505412-3/16(5) | 505413-1/4(5) | 505413-3/8(5) |

5 Nylon Brush Guards Included

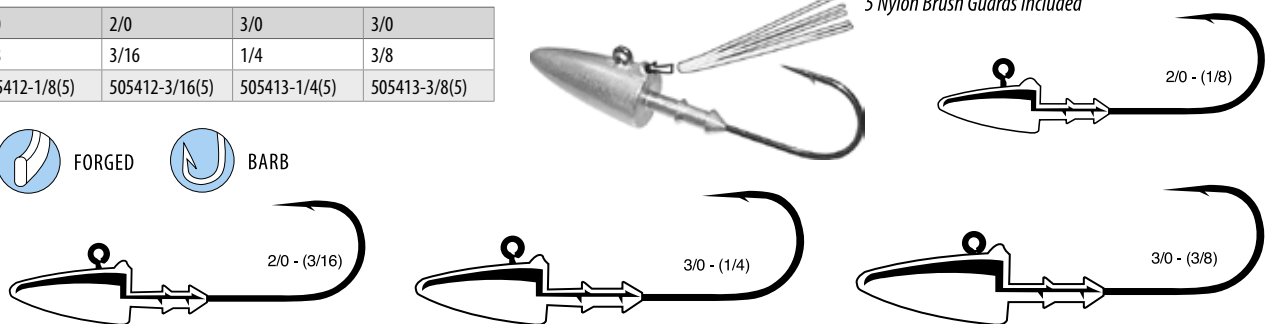

Tube Head

The ultimate finesse tube head design for precise presentations and smaller baits. Comes on a strong, sticky sharp NS Black hook that ensures solid hook ups.

| SIZES | | 2 | 2 | 2 |
|--------|----|----------------|----------------|---------------|
| WEIGHT | LS | 1/32 | 1/16 | 1/8 |
| | | 503409-1/32(5) | 503409-1/16(5) | 503409-1/8(5) |

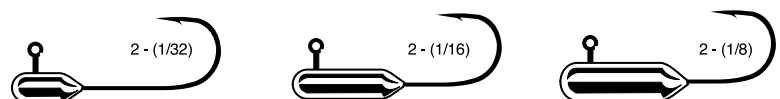

MaxEye Jig Pill Head

When it comes to drawing strikes from predatory fish such as walleye Gamakatsu's MaxEye jigs are as good as it gets. This premium jig features highly detailed life-like eyes and a durable paint finish that will not chip or flake. It also boasts a dual offset rebarb wire keeper and collar system, which will safely secure the softest and most-fragile plastics or live bait without tearing. The premium Big River Jig Hook sports an increased gap diameter to increase hook-ups and a special bend with an acute angle to provide better holding power. The MaxEye Pill Head jig has a unique shape which resists snags and imparts a unique action when it contacts the bottom.

| SIZES | | 1/0 | 1/0 | 2/0 | 2/0 | 2/0 |
|---------------------------|----|-------------------|--------------------|-------------------|-------------------|-------------------|
| WEIGHT | LS | 1/8 | 3/16 | 1/4 | 3/8 | 1/2 |
| Glow Silver Sparkle | | 439411-GL-1/8(3) | 439411-GL-3/16(3) | 439412-GL-1/4(3) | 439412-GL-3/8(3) | 439412-GL-1/2(3) |
| Chrome Chartreuse Sparkle | | 439411-CC-1/8(3) | 439411-CC-3/16(3) | 439412-CC-1/4(3) | 439412-CC-3/8(3) | 439412-CC-1/2(3) |
| Chrome Pink Sparkle | | 439411-CP-1/8(3) | 439411-CP-3/16(3) | 439412-CP-1/4(3) | 439412-CP-3/8(3) | 439412-CP-1/2(3) |
| Chrome Blue Sparkle | | 439411-CB-1/8(3) | 439411-CB-3/16(3) | 439412-CB-1/4(3) | 439412-CB-3/8(3) | 439412-CB-1/2(3) |
| Firetiger Sparkle | | 439411-FT-1/8(3) | 439411-FT-3/16(3) | 439412-FT-1/4(3) | 439412-FT-3/8(3) | 439412-FT-1/2(3) |
| Chrome Perch Sparkle | | 439411-CPR-1/8(3) | 439411-CPR-3/16(3) | 439412-CPR-1/4(3) | 439412-CPR-3/8(3) | 439412-CPR-1/2(3) |

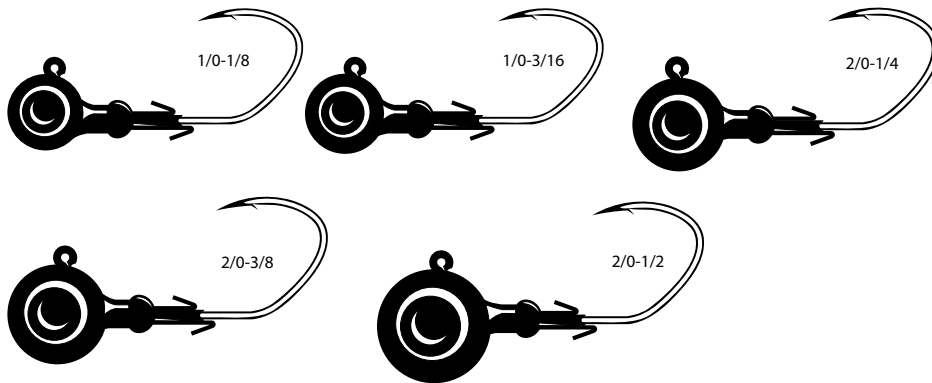

MaxEye Jig Swim Head

When it comes to drawing strikes from predatory fish such as walleye Gamakatsu's MaxEye jigs are as good as it gets. This premium jig features highly detailed life-like eyes and a durable paint finish that will not chip or flake. It also boasts a dual offset rebarb wire keeper and collar system, which will safely secure the softest and most-fragile plastics or live bait without tearing. The premium Big River Jig Hook sports an increased gap diameter to increase hook-ups and a special bend with an acute angle to provide better holding power. The MaxEye Swim Head jig has a special design that's great for use with any soft plastic swimbait, pairing perfectly with bulky plastics or smaller finesse baits.

| SIZES | | 3/0 | 3/0 | 4/0 | 4/0 | 4/0 |
|---------------------------|----|-------------------|-------------------|-------------------|-------------------|-------------------|
| WEIGHT | LS | 1/4 | 3/8 | 1/2 | 5/8 | 3/4 |
| Glow Silver Sparkle | | 440413-GL-1/4(3) | 440413-GL-3/8(3) | 440414-GL-1/2(3) | 440414-GL-5/8(3) | 440414-GL-3/4(3) |
| Chrome Chartreuse Sparkle | | 440413-CC-1/4(3) | 440413-CC-3/8(3) | 440414-CC-1/2(3) | 440414-CC-5/8(3) | 440414-CC-3/4(3) |
| Chrome Pink Sparkle | | 440413-CP-1/4(3) | 440413-CP-3/8(3) | 440414-CP-1/2(3) | 440414-CP-5/8(3) | 440414-CP-3/4(3) |
| Chrome Blue Sparkle | | 440413-CB-1/4(3) | 440413-CB-3/8(3) | 440414-CB-1/2(3) | 440414-CB-5/8(3) | 440414-CB-3/4(3) |
| Firetiger Sparkle | | 440413-FT-1/4(3) | 440413-FT-3/8(3) | 440414-FT-1/2(3) | 440414-FT-5/8(3) | 440414-FT-3/4(3) |
| Chrome Perch Sparkle | | 440413-CPR-1/4(3) | 440413-CPR-3/8(3) | 440414-CPR-1/2(3) | 440414-CPR-5/8(3) | 440414-CPR-3/4(3) |

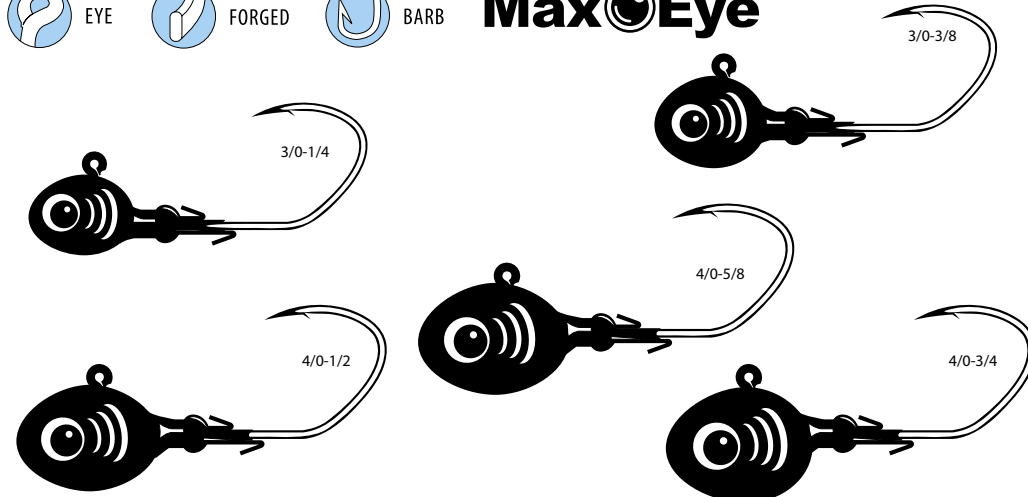



LURES

Spinnaker[®]

Spiral Z

Gamakatsu introduces the Spiral Z, a beaded attractor that will grab the attention of sportfish in both fresh and saltwater applications. The Spiral Z is ideal for trout and salmon in lakes or rivers that have grown accustomed to the same old-style attractors while also doing double duty with other species. Anglers employing the Spiral Z attractor to their lures will create an altogether new package with a distinct look, vibration and sound appeal. The attractor is built around a stainless-steel wire with colored beads in a variety of colors and a ball-bearing line swivel to eliminate line twists.

Unlike traditional dodgers and flashers, with the Spiral Z, the entire package rotates, creating an undulating lifelike motion for gamefish of every species. It's an infinitely customizable attractor and can be rigged any distance in front of a favorite lure. Pick the combination of size and color that fits the local fishery, add the lure of choice to complete the profile, and anglers can spin their way to bigger catches than ever before.

| SIZES | 2 in | 2 3/4 in |
|------------|-------------|-------------|
| Red | 441000-R(1) | 442000-R(1) |
| Pink | 441000-P(1) | 442000-P(1) |
| Orange | 441000-O(1) | 442000-O(1) |
| Chartreuse | 441000-C(1) | 442000-C(1) |
| Nickel | 441000-N(1) | 442000-N(1) |
| Gold | 441000-G(1) | 442000-G(1) |





BAITS

Spinnaker[®]

Gamakatsu®

DURASCENT

Durable • Scented • Floats • Flexible

Gamakatsu®, the longtime leader in hooks for everything from bluegills to blue marlin, has brought the company's unique talents for innovation into the soft bait market with the introduction of DuraScent baits. Whatever species anglers are chasing, there's a DuraScent offering tailor made for that purpose, with built-in features that outfish and outlast the competition.

All DuraScent baits are made in Japan to strict market standards which are reflected in both their hyper realism and their durability. DuraScent baits are extremely durable, lasting longer than traditional soft plastics which allows them to stand up to the toothiest fish. Super-soft elastomer provides extreme flexibility, allowing DuraScent baits to be stretched out to six times their original length. That means more time fishing, and less time re-rigging. DuraScent baits also float, which allows for a myriad of effective rigging options, taking advantage of natural currents to tempt anglers' prey.

DuraScent plastics are infused with an all-natural blend of fish-attracting scents including shrimp, crab, fish oil and squid. After extended use, the extreme scent in DuraScent baits can be "refreshed" with a good stretch or two. Made with a non-toxic formula that is free of plastisol and phthalates making them environmentally friendly.

XTREME
SCENT

No matter which species is targeted for the day, there's a DuraScent plastic that'll catch them better than anything else. When other soft plastics get overlooked, these get chewed.

DuraScent Shrimp

The DuraScent Shrimp perfectly emulates the favorite food of a wide variety of gamefish, from the natural body shape to the legs and antennae that move and sway in the water with only the slightest current or angler manipulation. Once fish spot it, they'll come in for a closer look, and the powerful shrimp scent will seal the deal. This is a soft plastic lure that can be fished from the top of the water column to the bottom, on weightless weedless hooks or a heavy jig. Rig it below a popping cork to target fish at a particular depth. The super-soft elastomer material floats and is extremely flexible stretching to over six times its length, making it far more durable than the competition, meaning anglers will spend more time reeling fish in and less time baiting hooks.

| SIZES | 2.3 in | 3.5 in |
|----------------|--------------|---------------|
| Natural | 448000-N(3) | 449000-N (3) |
| Orange Glitter | 448000-OG(3) | 449000-OG(3) |
| Angry Orange | 448000-AO(3) | 449000-AO (3) |

Actual size 2.3 inch.



Actual size 3.5 inch.



DuraScent Crab

The DuraScent Crab provides the look, smell and feel of the real thing, enough to tempt even the most neutral fish, with a combination of exceptional durability and lifelike characteristics. The super-soft elastomer material is buoyant, allowing the legs and claws to float upward to tempt curious fish from a distance, and once they get within sniffing range, they'll be brought closer by the all-natural crab infused scent. Gamakatsu's DuraScent crab is durable, lasts longer than traditional soft plastic baits and is extremely flexible, stretching up to six times its length. Whether bottom fishing, jigging, using a popping cork or just about any other presentation imaginable, this will bring in the most and biggest specimens of anglers desired inshore or offshore species.

| SIZES | 1 in |
|------------------|---------------|
| Red | 451000-R(4) |
| Pumpkin | 451000-PKN(4) |
| Green Gold Flake | 451000-GGF(4) |

Actual size 1 inch.



Red



Pumpkin

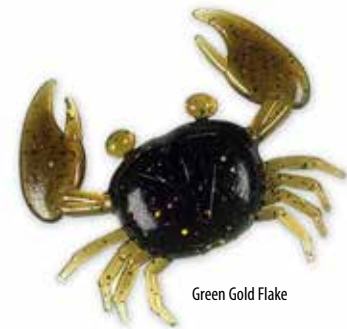

Green Gold Flake

DuraScent Sandworm

Gamakatsu's DuraScent Sandworm looks, moves, feels and smells like the real thing, providing lifelike motion with only the slightest bit of current or angler manipulation. Once fish see it, they'll be drawn in by the widely dispersed, all-natural fish oil scent, and once they bite, they'll hold on because it feels so lifelike. The super-soft floating elastomer material allows anglers to rig it in a wide variety of ways and is far more durable than traditional soft plastic baits or even actual worms. The DuraScent Sandworm offers extreme flexibility and can stretch to over six times its length. Whether surf fishing or chasing big fish in some other environment, this is the worm imitator anglers can't live without, a true gamechanger.

| SIZES | 3.3 in |
|---------|---------------|
| Pumpkin | 452000-PKN(5) |

Actual size 3 inch.



Pumpkin

DuraScent Octopus

The DuraScent Octopus brings eight legs of super durable and energetic action tempting fish with its undulating natural action. It comes in three sizes – 1.5 inches, 4.5 inches and 6 inches – to “match the hatch” and appeal to a wide array of gamefish. DuraScent Octopus are extremely durable lasting longer than traditional soft plastic octopus/hoochie style baits. Super-soft elastomer provides extreme flexibility and stretches to over 6 times its length. Its buoyant material floats, creating a natural look and feel that fish can’t resist. The 1.5 inch size is infused with shrimp scent and is ideal for targeting kokanee, trout, bass and panfish. The 4.5-inch size is infused with an all-natural blend of shrimp scent and is perfect for salmon and other larger species. Rig it behind a dodger or flasher, and the natural action and extreme scent will help trigger more strikes. The 6-inch size excels when targeting a wide variety of bigger bottom fish like halibut.

| SIZES | 1.5 in | 4.5 in | 6 in |
|---------------|---------------|---------------|---------------|
| Pink | 450000-P(5) | 450002-P(4) | 450004-P(2) |
| Orange | 450000-O(5) | 450002-O(4) | 450004-O(2) |
| Chartreuse | 450000-C(5) | 450002-C(4) | 450004-C(2) |
| Red | 450000-R(5) | 450002-R(4) | 450004-R(2) |
| Green | N/A | 450002-GR(4) | 450004-GR(2) |
| Glow | 450000-GL(5) | 450002-GL(4) | 450004-GL(2) |
| UV Pearl | 450000-PRL(5) | 450002-PRL(4) | 450004-PRL(2) |
| UV Holo Flake | 450000-HF(5) | 450002-HF(4) | 450004-HF(2) |



Actual size 6 inch.



Actual size 1.5 inch.



Actual size 4.5 inch.



DuraScent Salmon Eggs

DuraScent Salmon Eggs are so incredibly natural-looking that they're as good as the real thing. In fact, because of their exceptional durability and versatility, they may be better than the real thing. Whether fish are feeding by sight or scent, and whether anglers thread one egg on a hook or tie them in a cluster, the shrimp-infused extreme scent of these replicas will fool a wide variety of species into striking. Buoyant material that floats creates a natural look and feel that's deadly on steelhead, trout, salmon, panfish and just about any other species, versatile in both freshwater and saltwater. Anglers can tie several together using a series of overhand knots to adjust the amount of bait presented. Because of their incredible ability to stretch to over six times their length, anglers will spend less time rigging baits and more time reeling in fish.

| SIZES | 7 mm |
|------------|---------------|
| Red | 447000-R(5) |
| Creamside | 447000-CRM(5) |
| Cerise | 447000-CER(5) |
| Pearl Pink | 447000-PP(5) |
| Pink Sheen | 447000-PS(5) |

Actual size 7mm diameter (0.275 inch).

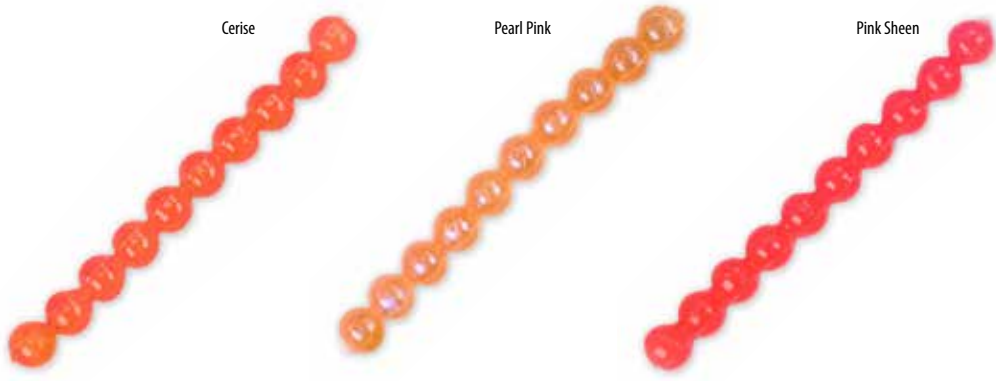
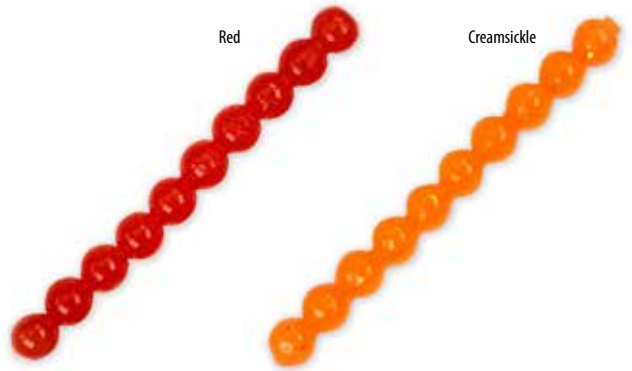





WEIGHTS

Spinnaker[®]

G-Shield Tungsten Worm Weight

The G-Shield Tungsten Worm Weight features a specially designed composite insert that not only protects an angler's line, but also provides 360-degree protection for the knot. The insert is wider at the base than at the insertion hole so the hook can recess itself into the weight, creating a more compact, lifelike and snag resistant offering. The worm weight is the all-purpose champ, best for casting into light cover or dragging plastics across bare lake and river bottoms when subtlety is essential and features a stealthy smoke colored finish. For easy identification the weight size is stamped into the side of each weight.

| SIZES | 1/8 | 3/16 | 1/4 | 3/8 | 1/2 | 3/4 |
|-------|---------------|----------------|---------------|---------------|---------------|---------------|
| Smoke | 446000-1/8(4) | 446000-3/16(4) | 446000-1/4(4) | 446000-3/8(3) | 446000-1/2(2) | 446000-3/4(2) |

Product shown larger than actual size



G-Shield Tungsten Flipping Weight

The G-Shield Tungsten Flipping Weight features a specially designed composite insert that not only protects an angler's line, but also provides 360-degree protection for the knot. The insert is wider at the base than at the insertion hole so the hook can recess itself into the weight, creating a more compact, lifelike and snag resistant offering. The flipping weight is slightly wider and excels when flipped or pitched into heavy cover and features a stealthy smoke colored finish. For easy identification the weight size is stamped into the side of each weight.

| SIZES | 3/8 | 1/2 | 5/8 | 3/4 | 1 | 1 1/4 |
|-------|---------------|---------------|---------------|---------------|-------------|-----------------|
| Smoke | 444000-3/8(3) | 444000-1/2(2) | 444000-5/8(2) | 444000-3/4(1) | 444000-1(1) | 444000-1 1/4(1) |

Product shown larger than actual size



G-Shield Tungsten Punch Weight

The G-Shield Tungsten Punch Weight features a specially designed composite insert that not only protects an angler's line, but also provides 360-degree protection for the knot. The insert is wider at the base than at the insertion hole so the hook can recess itself into the weight, creating a more compact, lifelike and snag resistant offering. The punch weight will penetrate thick overhead canopies that resist other shapes. It's bulbous at the front, creating a weight-forward design that builds inertia when it first contacts likely bass-holding cover and features a stealthy smoke colored finish. For easy identification the weight size is stamped into the side of each weight.

| SIZES | 3/4 | 1 | 1 1/4 | 1 1/2 | 2 |
|-------|---------------|-------------|-----------------|-----------------|-------------|
| Smoke | 445000-3/4(1) | 445000-1(1) | 445000-1 1/4(1) | 445000-1 1/2(1) | 445000-2(1) |

Product shown larger than actual size



Tungsten Hybrid Swing Head

With a head design that unites the benefits of both a cobra head, for passing through grass, and a football head, for snag resistance on a hard bottom, the Tungsten Hybrid Swing Head creates a natural looking, slithering action that draws major attention from nearby bass. Ideal for slow swimming retrieves, the head increases the action of any plastic bait along the bottom. The precision wire harness is tuned to exacting tolerances and a recessed line tie helps it stay weedless. For easy identification the weight size is stamped into the side of each weight and features a stealthy smoke-colored finish.

| SIZES | 3/8 | 1/2 | 3/4 | 1 |
|-------|---------------|---------------|---------------|-------------|
| Smoke | 443000-3/8(1) | 443000-1/2(1) | 443000-3/4(1) | 443000-1(1) |

Product shown larger than actual size.



TG Trigger Nail Weight

The TG Trigger Nail Weight brings a refined approach to the popular Neko fishing technique with its high-grade tungsten construction and polished finish for effortless rigging. Equipped with a double trigger wire keeper that compresses when inserted into soft plastics, it ensures excellent retention. Standard weights can easily come out during casts or when a fish is jumping, the unique trigger wire always holds this weight in place. Weight stamps on each provide quick identification, making tackle organization a breeze.

| SIZES | 1/16 | 3/32 | 1/8 |
|-------|----------------|----------------|---------------|
| Tin | 485000-1/16(4) | 485000-3/32(4) | 485000-1/8(3) |

Product shown larger than actual size.





SALTWATER HOOKS

Spalkakatsu[®]

Live Bait

Our most versatile Live Bait Hook. Sticky sharp, super strong and designed to handle tough saltwater fish.

| SIZES | | 12 | 10 | 8 | 6 | 4 | 2 | 1 | 1/0 | 2/0 | 3/0 | 4/0 | 5/0 | 6/0 | 7/0 | 8/0 | 9/0 | 10/0 | 11/0 |
|----------|-----|-----------|-----------|-----------|-----------|-----------|-----------|-----------|-----------|-----------|-----------|-----------|-----------|-----------|-----------|----------|----------|----------|----------|
| NS Black | LS | 18404(9) | 18405(9) | 18406(8) | 18407(8) | 18408(7) | 18409(7) | 18410(6) | 18411(6) | 18412(5) | 18413(4) | 18414(4) | 18415(4) | 18416(3) | 18417(3) | 18418(2) | 18419(2) | 18420(2) | 18421(2) |
| | 25 | | | 18406-25 | 18407-25 | 18408-25 | 18409-25 | 18410-25 | 18411-25 | 18412-25 | 18413-25 | 18414-25 | 18415-25 | 18416-25 | 18417-25 | 18418-25 | 18419-25 | | |
| | 100 | 18404-100 | 18405-100 | 18406-100 | 18407-100 | 18408-100 | 18409-100 | 18410-100 | 18411-100 | 18412-100 | 18413-100 | 18414-100 | 18415-100 | 18416-100 | 18417-100 | 18418-50 | 18419-50 | | |

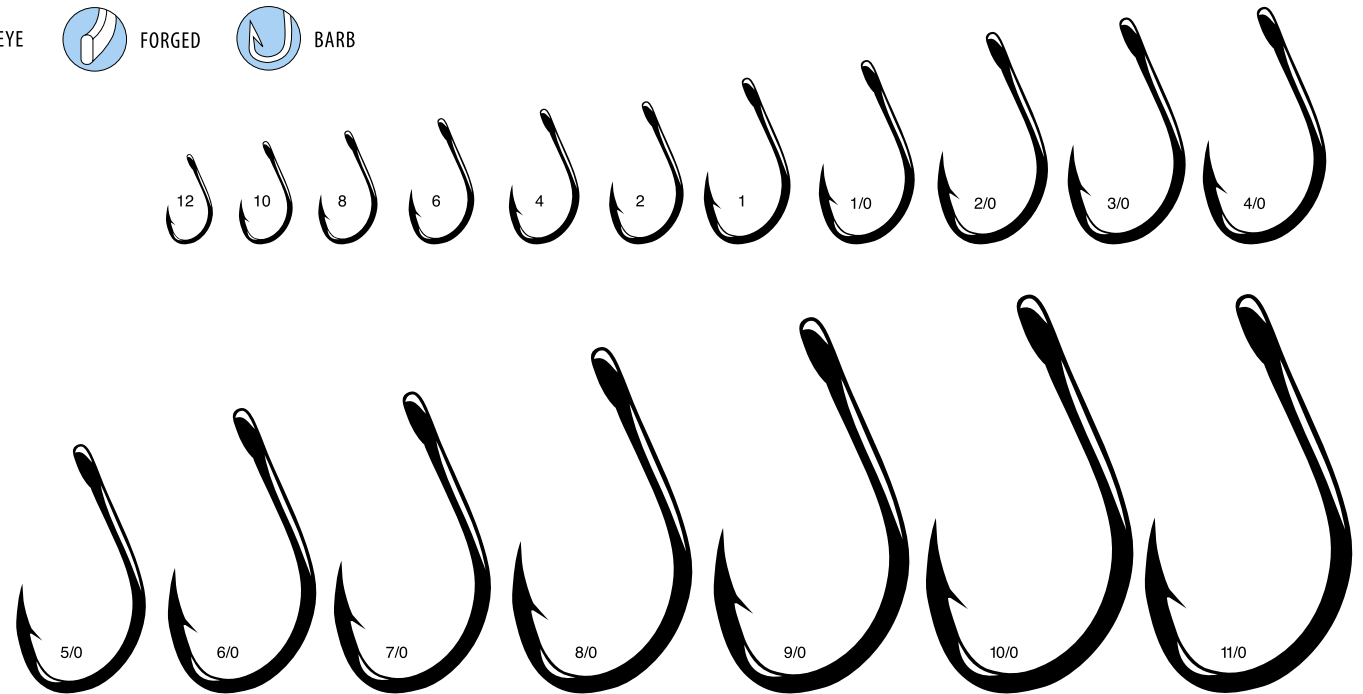

Live Bait with Solid Ring

Our standard Live Bait hook with a solid one piece ring for a natural presentation. Much smoother than any welded ringed hook, these are designed for larger baits and heavier lines.

| SIZES | | 2 | 1 | 1/0 | 2/0 | 3/0 | 4/0 |
|----------|----|-----------|-----------|-----------|-----------|-----------|-----------|
| NS Black | LS | 18409R(7) | 18410R(6) | 18411R(6) | 18412R(5) | 18413R(5) | 18414R(4) |
| | 25 | 18409R-25 | 18410R-25 | 18411R-25 | 18412R-25 | 18413R-25 | 18414R-25 |

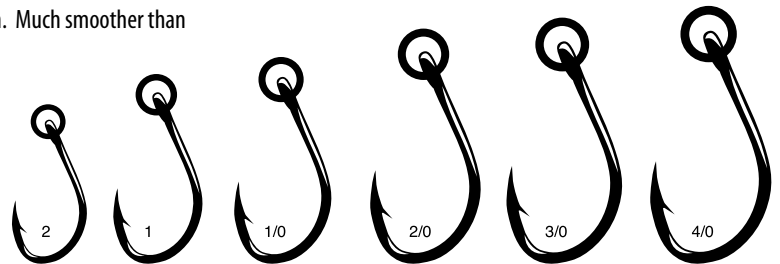

Live Bait Light Wire

| SIZES | | 6 | 4 | 2 | 1 | 1/0 | 2/0 | 3/0 |
|----------|----|-----------|-----------|-----------|-----------|-----------|-----------|-----------|
| NS Black | LS | 220407(8) | 220408(7) | 220409(7) | 220410(6) | 220411(6) | 220412(5) | 220413(5) |

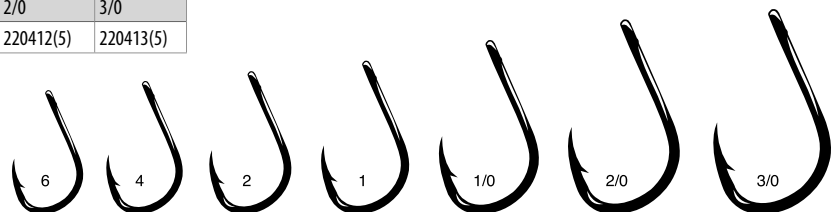

Live Bait Light Wire with Solid Ring

Super smooth solid one piece ring attached to the Light Wire Live Bait hook. The perfect hook for small live baits and delicate presentations.

| SIZES | | 6 | 4 | 2 | 1 |
|----------|----|------------|------------|------------|------------|
| NS Black | LS | 220407R(7) | 220408R(6) | 220409R(6) | 220410R(6) |
| | 25 | 220407R-25 | 220408R-25 | 220409R-25 | 220410R-25 |

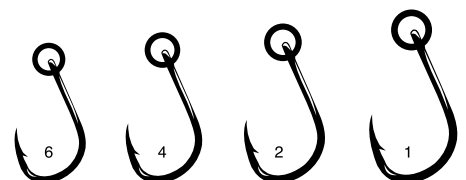

Live Bait Heavy Duty

Heavy wire and forged for extra strength, this hook is the go to hook for big fish on big baits.

| SIZES | | 1/0 | 2/0 | 3/0 | 4/0 | 5/0 | 6/0 | 7/0 | 8/0 | 9/0 | 10/0 | 11/0 |
|----------|------|-----------|-----------|-----------|-----------|-----------|-----------|-----------|----------|----------|----------|----------|
| NS Black | LS | 00411(8) | 00412(7) | 00413(7) | 00414(6) | 00415(6) | 00416(5) | 00417(5) | 00418(4) | 00419(4) | 00420(3) | 00421(3) |
| | 25 | 00411-25 | 00412-25 | 00413-25 | 00414-25 | 00415-25 | 00416-25 | 00417-25 | 00418-25 | 00419-25 | 00420-25 | 00421-25 |
| | Bulk | 00411-100 | 00412-100 | 00413-100 | 00414-100 | 00415-100 | 00416-100 | 00417-100 | 00418-50 | 00419-50 | 00420-50 | 00421-50 |

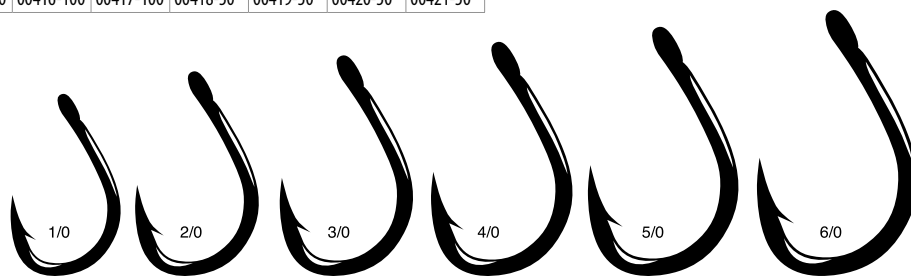

Live Bait Heavy Duty with Solid Ring

A heavier Live Bait hook with a ring. Designed for bigger baits and heavier lines.

| SIZES | | 1/0 | 2/0 | 3/0 | 4/0 | 5/0 | 6/0 |
|----------|----|-----------|-----------|-----------|-----------|-----------|-----------|
| NS Black | LS | 00411R(5) | 00412R(5) | 00413R(5) | 00414R(4) | 00415R(4) | 00416R(4) |
| | 25 | 00411R-25 | 00412R-25 | 00413R-25 | 00414R-25 | 00415R-25 | 00416R-25 |



Live Bait Heavy Duty Circle, **TOURNAMENT LEGAL**

Same design as the Live Bait Heavy Duty, but with a non-offset circle hook point. The perfect hook for giant fish on big chunk baits.

| SIZES | | 6/0 | 7/0 |
|----------|----|-----------|-----------|
| NS Black | LS | 210416(5) | 210417(5) |

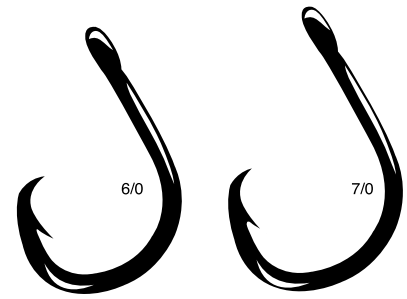

Nautilus Circle

One of the meanest circle hook designs around. The Nautilus grabs its prey and simply doesn't let go. This hook can be used for live bait or chunk bait presentations and has proven its strength many times.

| SIZES | | 4 | 2 | 1 | 1/0 | 2/0 | 3/0 | 4/0 | 5/0 | 6/0 |
|----------|----|----------|----------|----------|----------|----------|----------|----------|----------|----------|
| NS Black | LS | 42408(8) | 42409(8) | 42410(8) | 42411(7) | 42412(7) | 42413(6) | 42414(6) | 42415(5) | 42416(5) |
| | 25 | | | 42410-25 | 42411-25 | 42412-25 | 42413-25 | 42414-25 | 42415-25 | 42416-25 |

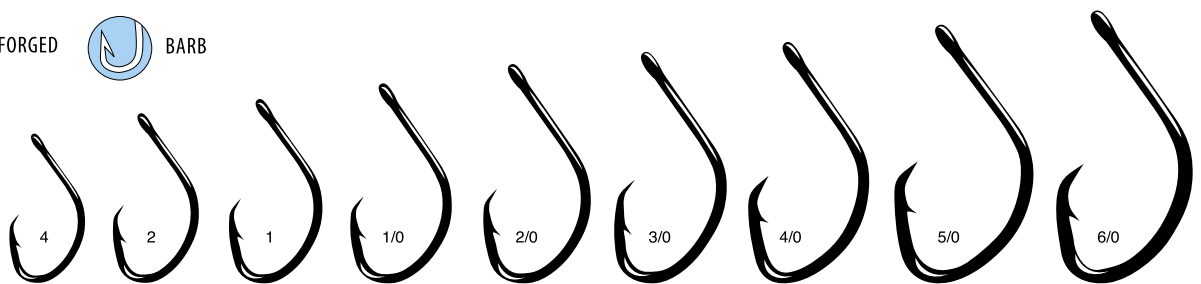
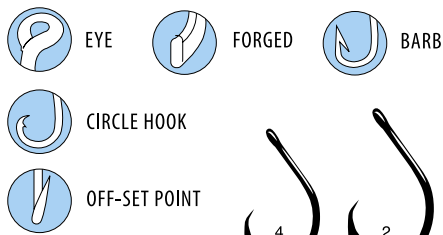

Nautilus Circle with Solid Ring

The most popular circle hook with solid ring, grabs its prey and simply does not let go.

| SIZES | | 4 | 2 | 1 | 1/0 | 2/0 | 3/0 | 4/0 | 5/0 | 6/0 |
|----------|----|-----------|-----------|-----------|-----------|-----------|-----------|-----------|-----------|-----------|
| NS Black | LS | 42408R(5) | 42409R(5) | 42410R(5) | 42411R(5) | 42412R(5) | 42413R(5) | 42414R(4) | 42415R(4) | 42416R(4) |
| | 25 | | | | | 42412R-25 | 42413R-25 | 42414R-25 | 42415R-25 | 42416R-25 |

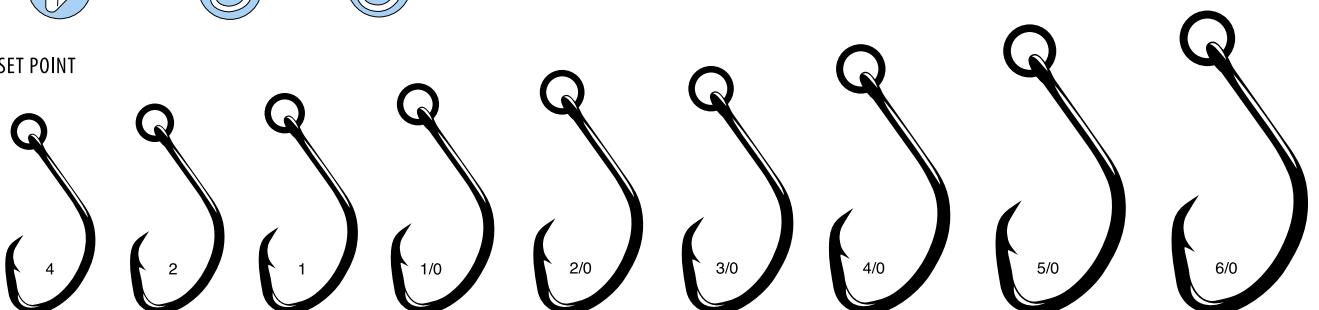
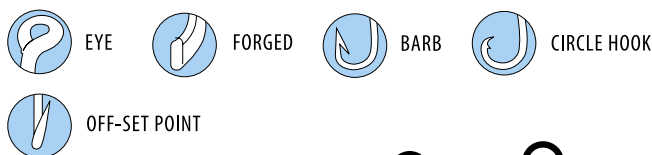

Nautilus Light

A light wire hook that was developed for fishing fragile live baits. Produced from forged high carbon steel, it features a straight eye and offset point for superior hooking performance. The unique circle hook shape is designed to hook and hold which is precisely why more saltwater anglers make Gamakatsu their hook-of-choice. Superior strength, sharpness and design add-up to make a sure bet for live bait and chunk bait anglers from coast-to-coast.

| Sizes | 2 | 1 | 1/0 | 2/0 | 3/0 | 4/0 | 5/0 |
|----------|--------------|-----------|-----------|-----------|-----------|-----------|-----------|
| NS Black | LS 332409(8) | 332410(8) | 332411(7) | 332412(6) | 332413(5) | 332414(5) | 332415(4) |

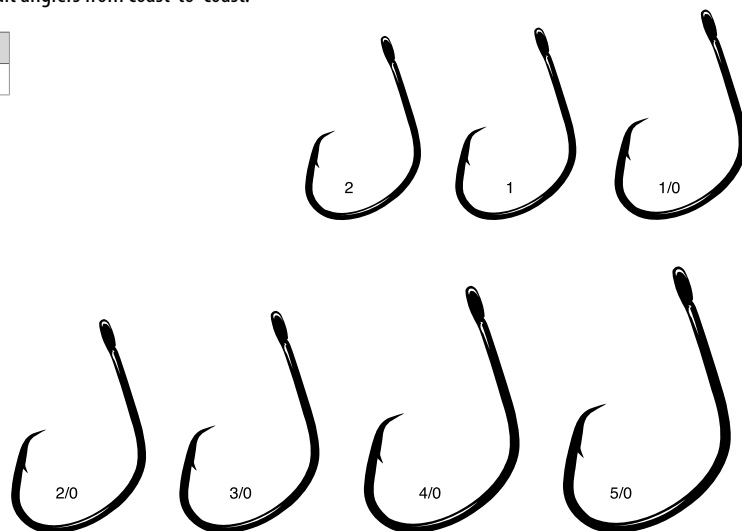
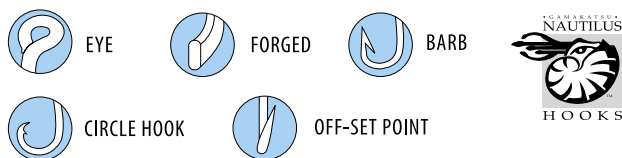

Nautilus Circle Heavy Duty

To go ringed or not to go ringed... that is the question! And we've got the answer, whichever you prefer. The standard Nautilus HD hook features a ringless eye and 30% heavier wire than the regular Nautilus. (Roughly 50% less heavy than the Super Nautilus.) Whether you simply prefer the stealthiness of having less metal in the water or just have great confidence in the loop knots you've tied for years, the standard Nautilus HD hook will do the trick. You can feel the superiority by just holding it in your hand. Be careful when checking the sharpness; it doesn't differentiate between fish or fingers.

| SIZES | 2/0 | 3/0 | 4/0 | 5/0 | 6/0 |
|----------|--------------|-----------|-----------|-----------|-----------|
| NS Black | LS 377412(7) | 377413(6) | 377414(6) | 377415(5) | 377416(5) |
| | 25 377412-25 | 377413-25 | 377414-25 | 377415-25 | 377416-25 |

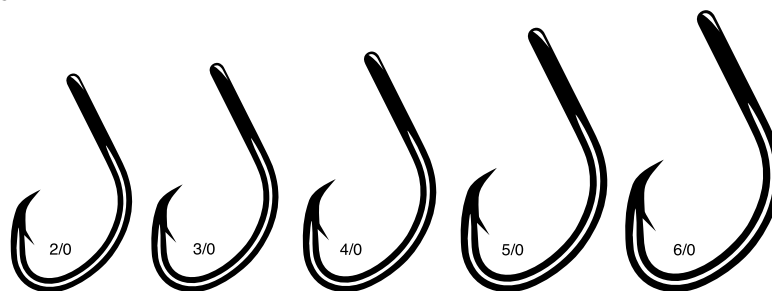
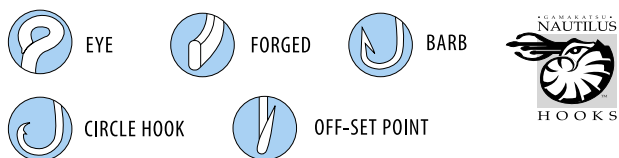

Nautilus Circle Heavy Duty With Solid Ring

The new solid, one-piece ringed version of the Nautilus HD hook allows live bait to swim more freely, keeping it alive longer and enticing more prey to engulf its goodness. At that point, the finest high carbon steel penetrates deep and locks in tight for the battle ahead. The Ringed Nautilus HD features 30% heavier wire than the regular Nautilus and 50% less than the Super Nautilus. While its core credibility has been proven in the southern California Bluefin Tuna fisheries, there is absolute evidence of its prowess in many other heavyweight bouts with monster gamefish worldwide. Therefore, you owe it to yourself to try the Nautilus HD Ringed for all live bait techniques and bottomfish applications. Big blues and channel cats? Absolutely! Sturgeon? Oh yeah. Halibut? It's a no-brainer. Tie one on without a single regret.

| SIZES | 2/0 | 3/0 | 4/0 | 5/0 | 6/0 |
|----------|---------------|------------|------------|------------|------------|
| NS Black | LS 377412R(5) | 377413R(5) | 377414R(4) | 377415R(4) | 377416R(4) |
| | 25 377412R-25 | 377413R-25 | 377414R-25 | 377415R-25 | 377416R-25 |

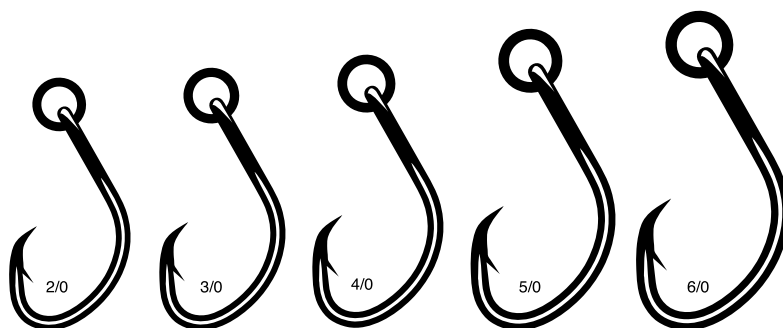
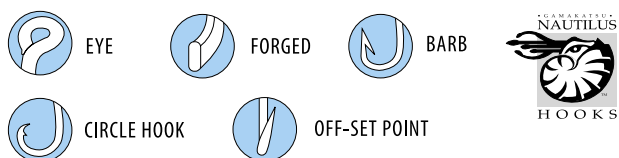

Super Nautilus Circle

Made of high carbon steel, it's a heavier wire hook than our standard "Nautilus" and forged for quality and added strength. This hook has become a favorite amongst demanding saltwater fishermen.

| SIZES | 10/0 | 11/0 |
|----------|--------------|-----------|
| NS Black | LS 272420(3) | 272421(2) |

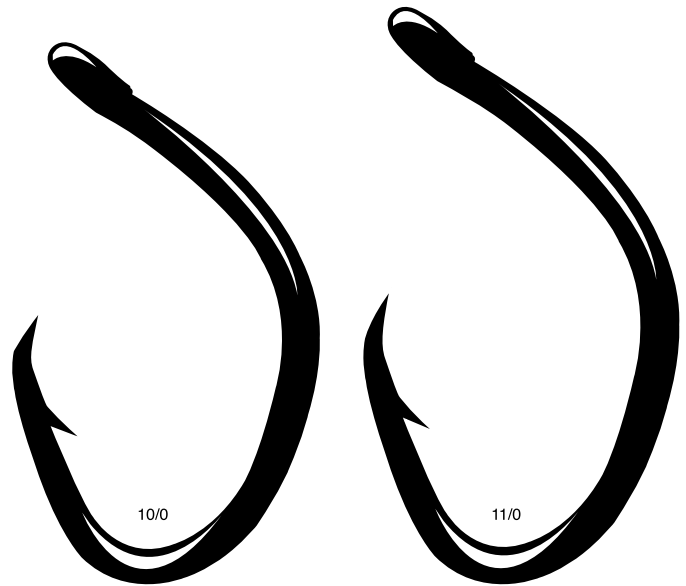
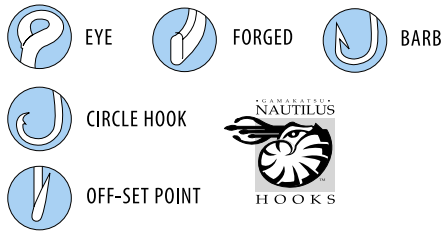

Kraken Outbarb Circle (Inline-point) **TOURNAMENT LEGAL**

The Kraken Outbarb Circle's distinctive outside barb provides several advantages when targeting giant sized fish. One is straight holding power, because the outbarb cannot back out like a traditional barbed hook, and hook damage typically occurs on the opposite side of the hook, further reducing potential pull-out. Another is better, easier penetration because the barb is opposite the side of the hook doing most of the work. It's also less likely anglers' line will catch on the barb if it wraps around the hook on the drop or cast.

| SIZES | 1/0 | 2/0 | 3/0 | 4/0 | 5/0 | 6/0 | 7/0 | 8/0 | 9/0 | 10/0 |
|----------|--------------|-----------|-----------|-----------|-----------|-----------|-----------|-----------|-----------|-----------|
| NS Black | LS 438411(7) | 438412(7) | 438413(7) | 438414(6) | 438415(6) | 438416(6) | 438417(5) | 438418(4) | 438419(4) | 438420(3) |

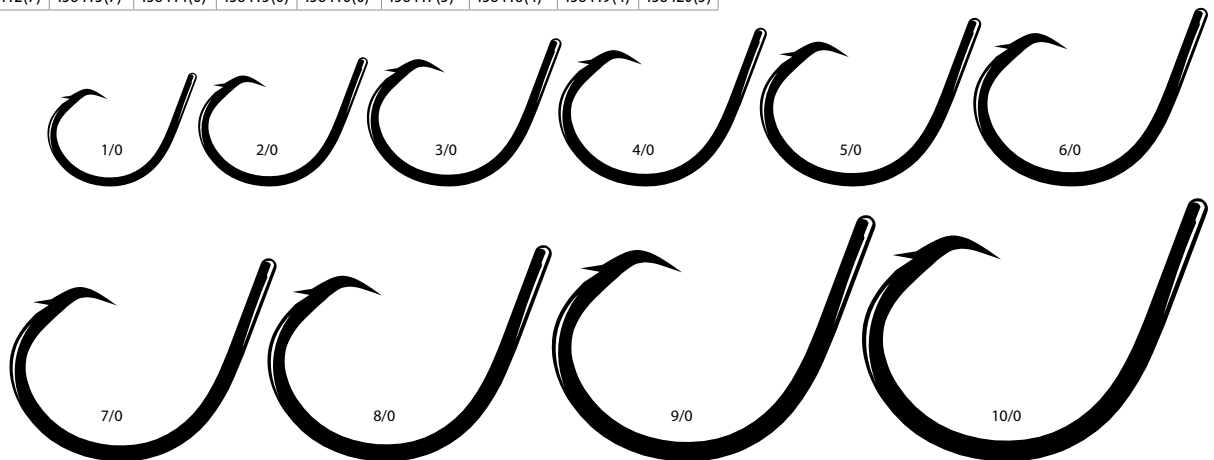
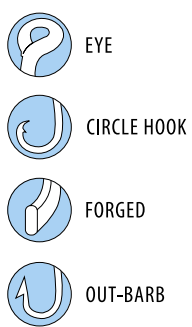

Kraken Circle Monster (Inline-point) **TOURNAMENT LEGAL**

The Kraken Circle Monster was developed for use with larger chunk baits and provides the strength and size to target giant fish. The circle hook is a time-tested and proven design, and the wide gap ensures reliable hook-ups even with the largest jawed fish. Their monster-sized eye provides anglers a range of rigging options including heavy tuna cord, mono, fluoro and even wire. The straight eye design offers the option of snelling or crimping.

| SIZES | 14/0 | 16/0 |
|----------|--------------|-----------|
| NS Black | LS 436424(2) | 436426(2) |

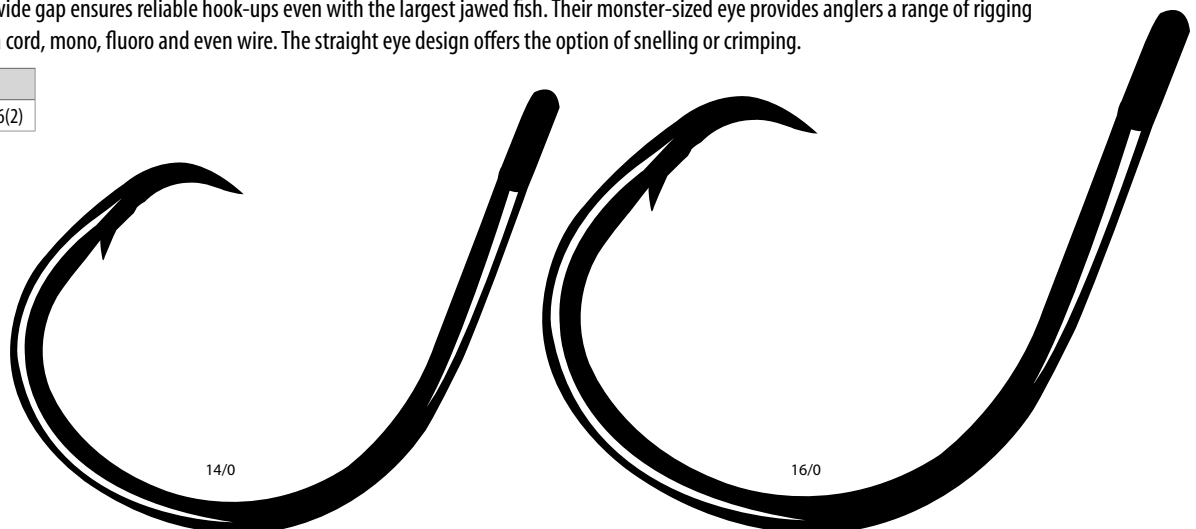
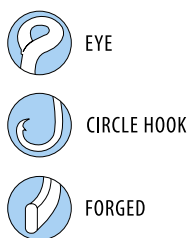

Octopus Circle, 4x Strong, Straight Eye (Offset-point)

This hook is designed for heavier lines and bigger fish. The offset point makes it a good choice for many chunk bait situations.

| SIZES | | 1/0 | 2/0 | 3/0 | 4/0 | 5/0 | 6/0 | 7/0 | 8/0 |
|------------|----|-----------|-----------|-----------|-----------|-----------|-----------|-----------|-----------|
| NS Black | LS | 209411(6) | 209412(6) | 209413(6) | 209414(6) | 209415(6) | 209416(6) | 209417(6) | 209418(6) |
| | 25 | | | | | 209415-25 | 209416-25 | 209417-25 | 209418-25 |
| Nano Alpha | LS | 209211(6) | 209212(6) | 209213(6) | 209214(6) | 209215(6) | | | |

 EYE
  FORGED
  BARB
 NANO ALPHA

 CIRCLE HOOK

 OFF-SET POINT

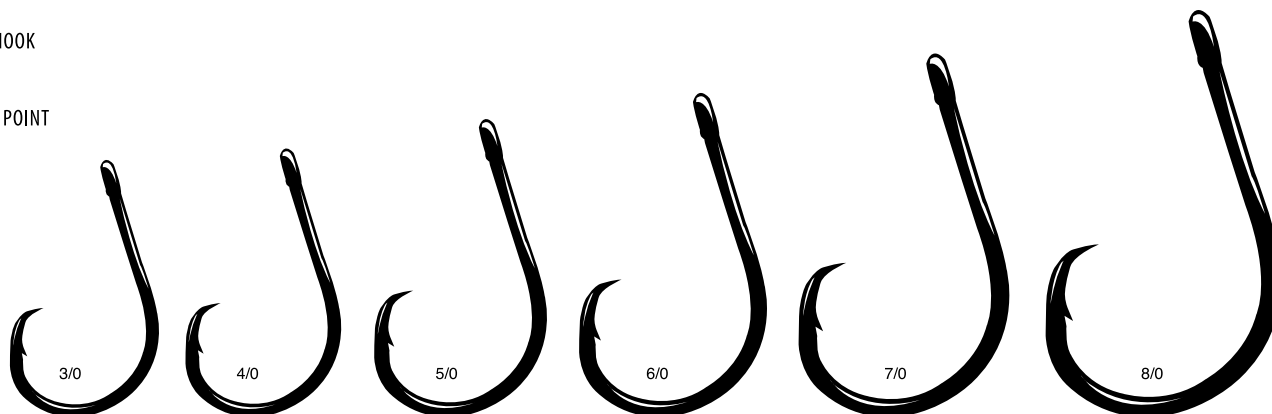
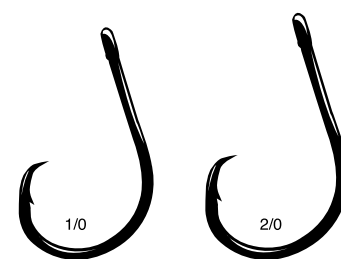

Octopus Circle, 4x Strong, Straight Eye (Inline-point) **TOURNAMENT LEGAL**

To comply with new angling regulations in the Gulf of Mexico, we've redesigned and reinforced our most popular circle hook. The new 4X Strong Circle Hook is built for the toughest battles in the deep sea. The straight eye, NS Black finish and inline point (not offset) complies with the new rules, but doesn't reduce the hook's effectiveness. This is the new "go-to" hook charter captains and professional anglers are using for deep dropping and reef and wreck fishing. Heavy up your rods, reels and line, because the 4X Strong Circle Hook will never give up when it comes to pulling snapper and monster grouper out of their fortified hangouts.

| SIZES | | 1/0 | 2/0 | 3/0 | 4/0 | 5/0 | 6/0 | 7/0 | 8/0 | 9/0 |
|------------|----|-----------|-----------|-----------|-----------|-----------|-----------|-----------|-----------|-----------|
| NS Black | LS | 360411(6) | 360412(6) | 360413(6) | 360414(6) | 360415(6) | 360416(6) | 360417(6) | 360418(6) | 360419(5) |
| Nano Alpha | LS | | | | 360214(6) | 360215(6) | 360216(6) | 360217(6) | 360218(6) | 360219(6) |

 EYE
  FORGED
  BARB
  CIRCLE HOOK

NANO ALPHA

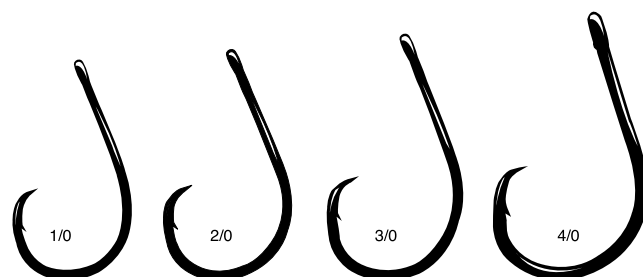

O'Shaughnessy

Traditional saltwater style for trolling or general purpose bait fishing.

| SIZES | | 1/0 | 2/0 | 3/0 | 4/0 | 5/0 | 6/0 | 7/0 | 8/0 | 9/0 | 10/0 |
|-------|-----|-----------|-----------|-----------|-----------|-----------|----------|----------|----------|----------|----------|
| Tin | LS | 13011(6) | 13012(5) | 13013(5) | 13014(4) | 13015(4) | 13016(3) | 13017(3) | 13018(2) | 13019(2) | 13020(2) |
| | 100 | 13011-100 | 13012-100 | 13013-100 | 13014-100 | 13015-100 | 13016-50 | 13017-50 | 13018-30 | 13019-30 | 13020-20 |

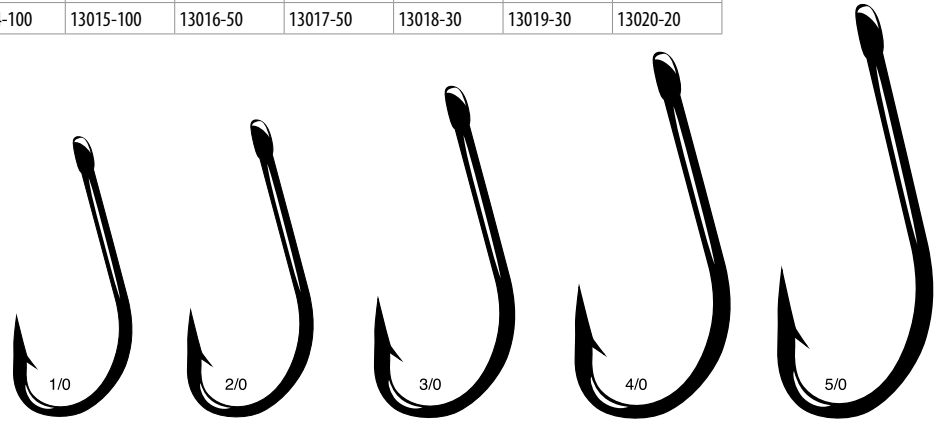

Single Hook 53 Salt

Purpose built for saltwater plug applications, the Single Hook 53 Salt incorporates a large inline eye designed to fit seamlessly onto split rings. The Magic Eye ensures easy attachment and removal, while Hyper Shield coating increases corrosion resistance and maintains sharp hook points longer. The inline configuration helps maintain proper lure tracking and consistent hookups in harsh saltwater conditions.

| SIZES | | 8 | 6 | 4 | 2 | 1 | 1/0 | 2/0 |
|-------|----|------------|------------|------------|------------|------------|------------|------------|
| Tin | LS | 489806(10) | 489807(10) | 489808(10) | 489809(10) | 489810(10) | 489811(10) | 489812(10) |

NEW

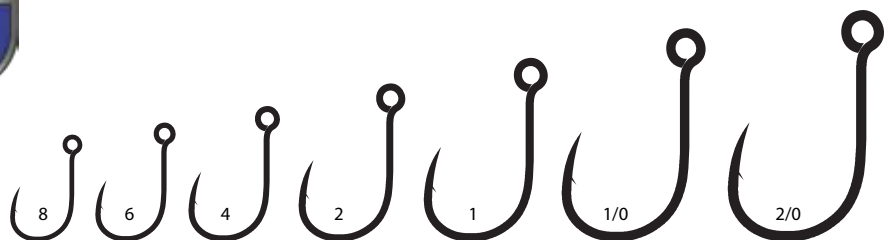

Magic Eye Pluggin Hook HD

Finding the right replacement hook for your favorite lure just got easier. The Magic Eye Pluggin Hook HD is the perfect choice when looking for a heavy-duty hook to replace the factory trebles on your best plugs. The Magic Eye's beveled hook eye makes it easier to attach on the split ring without needing special pliers or tools. Using two single point hooks versus treble hooks will increase hookup ratios and make it much easier to release the fish. Simply attach to your lure with the hook points opposed and get ready to battle.

| SIZES | | 10/0 | 11/0 | 12/0 |
|-------|----|-----------|-----------|-----------|
| TIN | LS | 418520(2) | 418521(2) | 418522(2) |

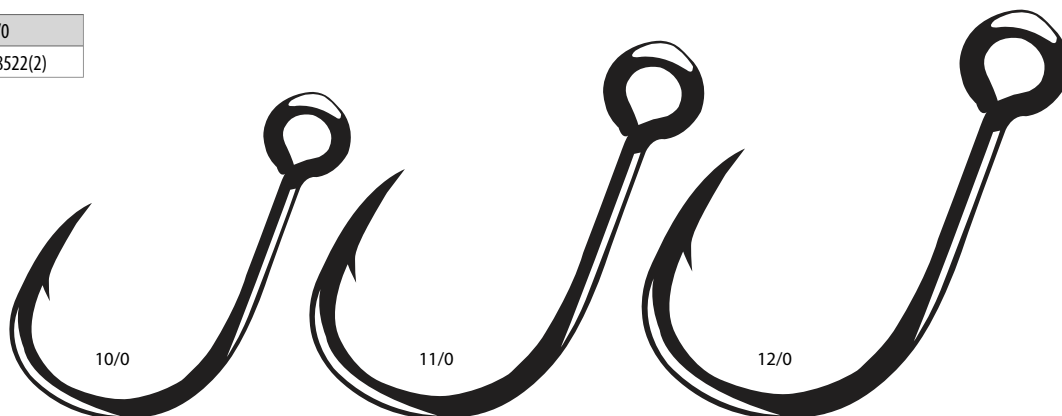

Magic Eye Tuna Plug 3X

You've likely heard about the advantages of using tandem Gamakatsu double, single-point hooks instead of factory trebles on your favorite tuna plugs. Hookup ratios increase and releases are far kinder to our finned friends. Magic Eye Tuna Plug 3X Hooks make rigging the system dramatically easier because the hook eyes are beveled so they slide right on a split ring without needing special pliers or tools. It's faster, easier and foolproof. Attach with hook points opposed.

| SIZES | | 3/0 | 4/0 | 5/0 | 6/0 | 7/0 |
|-------|----|-----------|-----------|-----------|-----------|-----------|
| TIN | LS | 365513(5) | 365514(5) | 365515(5) | 365516(4) | 365517(4) |

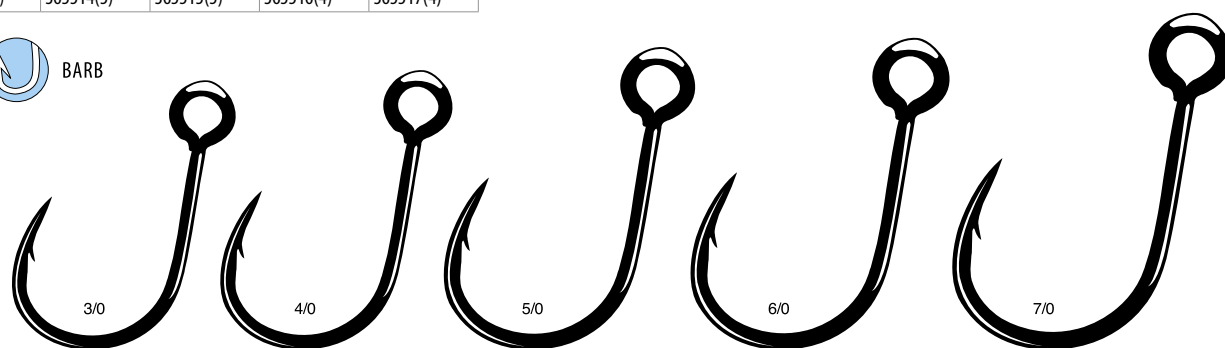

Tuned Tuna Plug with Ring

Angler preferences can differ on whether to use a ringed hooked or not. And that's just fine with us because we manufacture both. Our Tuned Tuna Plug hook is now available with a welded ring. The ring provides more freedom for the hook(s) to swing unencumbered. Anglers have also found success using the ringed Tuned Tuna Plug hook for stiff rigs, thus eliminating the need for a shackle. Without reservation, they're ready for battle.

| SIZES | | 10/0 | 11/0 | 12/0 |
|-------|----|-----------|-----------|-----------|
| TIN | LS | 379520(2) | 379521(2) | 379522(2) |

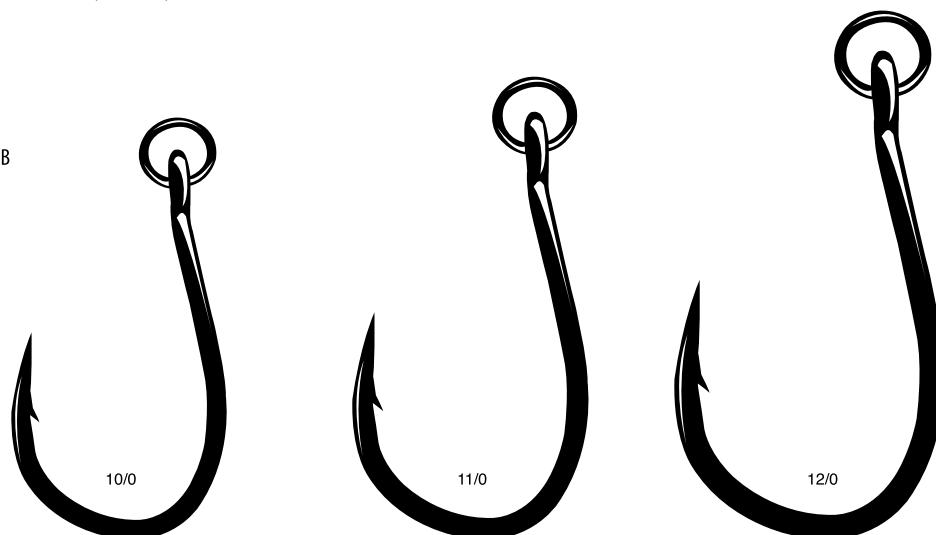

Pluggin' Single HD - Ringed

Built for anglers upgrading their favorite plugs, the Gamakatsu Pluggin' Single HD – Ringed delivers heavy-duty strength and refined performance in a streamlined single-hook design. Featuring a solid ring connection for enhanced freedom of movement and more natural lure action, this hook reduces leverage during the fight while improving hook retention and fish handling. Forged from high-carbon steel with a needle-sharp point, it's engineered to handle powerful saltwater species and aggressive strikes with confidence, making it an ideal replacement for traditional trebles when strength, penetration, and control matter most.

| SIZES | | 7/0 | 8/0 | 9/0 | 10/0 | 11/0 |
|-------|----|------------|------------|------------|------------|------------|
| Tin | LS | 486517 (2) | 486518 (2) | 486519 (2) | 486520 (2) | 486521 (2) |

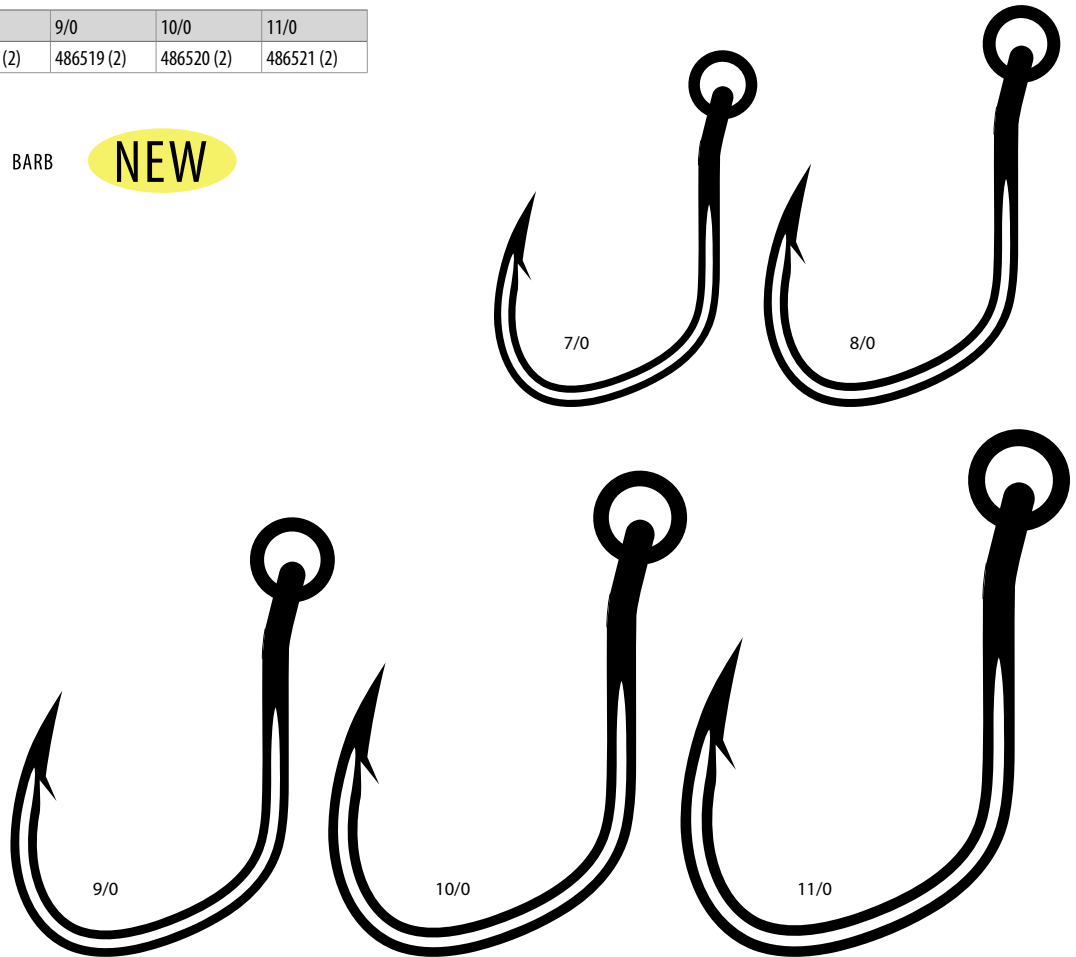

Single 620 HD

The 620 HD is designed for the DIY (Do It Yourself) anglers that want to make and use their own assist hooks. These hooks offer anglers the ability to customize the length of the dropper lines and their hook configuration. The 620 HD hook is designed to target tuna, giving anglers a heavy-duty hook option with a greater capacity to easily handle larger fish. The surface of each 620 HD hook has a Hypershield coating that dramatically increases corrosion resistance allowing anglers to spend more time fishing and less time changing out rusty hooks.

| SIZES | | 5/0 | 6/0 | 7/0 |
|-------------|----|------------|------------|------------|
| HYPERSHIELD | LS | 455515 (2) | 455516 (2) | 455517 (2) |

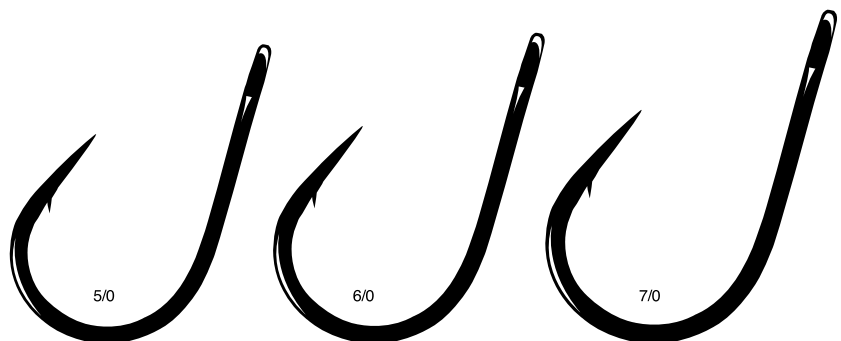

Grouper Hook

The Grouper hook was designed to hold large baits or bait chunks when fishing for groupers or other large predators. This hook is built with an oversize eye to accommodate large lb test line choices including heavy mono, tuna cord or wire. The Grouper hook is also excellent for large bait chunks used for tuna fishing. It has the strength to hold and handle the largest saltwater fish.

| SIZES | | 10/0 | 12/0 | 14/0 |
|-------|----|------------|------------|------------|
| TIN | LS | 458520 (2) | 458522 (2) | 458524 (2) |

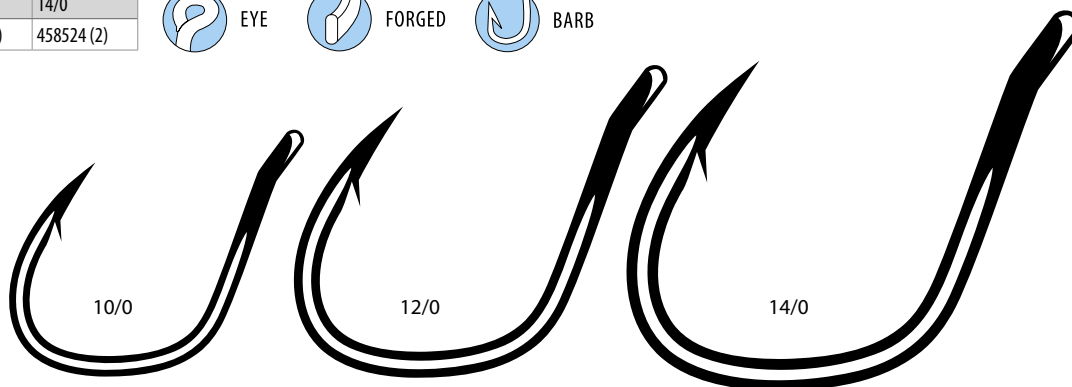

Big Eye Circle **TOURNAMENT LEGAL**

Our standard circle hook designed with a big eye for rigging heavier monos or dacrons. Also good for chunking for tuna and halibut.

| SIZES | | 6/0 | 7/0 | 8/0 | 9/0 | 10/0 | 11/0 |
|-------|----|----------|----------|----------|----------|----------|----------|
| TIN | LS | 12050(5) | 12051(4) | 12052(4) | 12053(3) | 12054(3) | 12055(2) |



Tuned Tuna With Welded Eye

A great hook for Stiff Rigs and other trolling applications. The forged needle point helps ensure a solid hook set. New welded eye will not open or flex.

| SIZES | | 8/0 | 9/0 | 10/0 | 11/0 |
|-------|----|-----------|-----------|-----------|-----------|
| TIN | LS | 369018(3) | 369019(3) | 369020(2) | 369021(2) |

-  WELDED EYE
-  FORGED
-  BARB

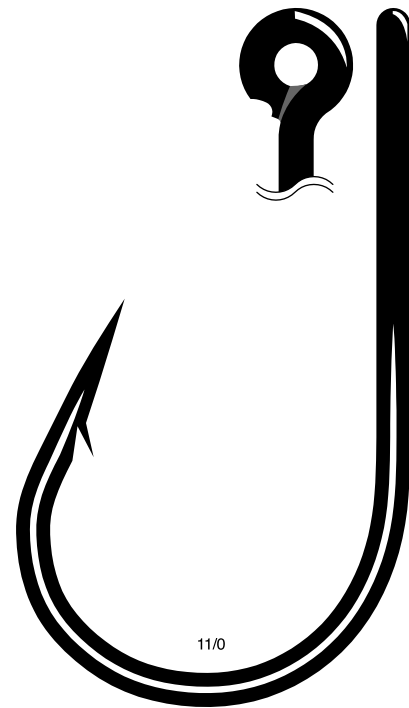
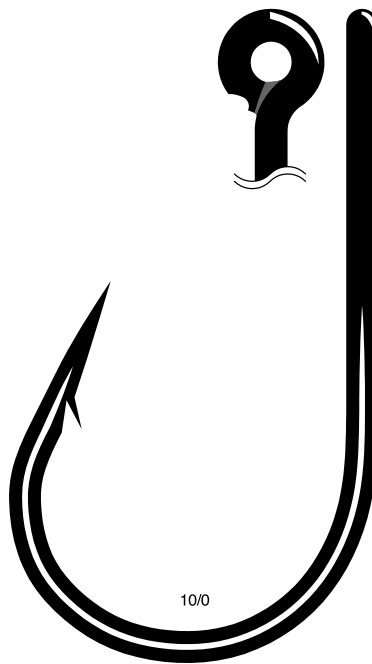
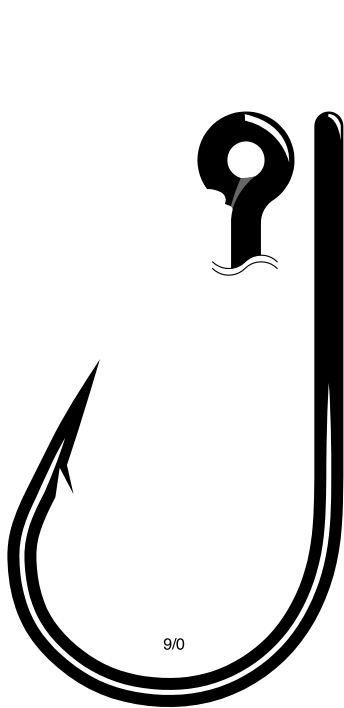
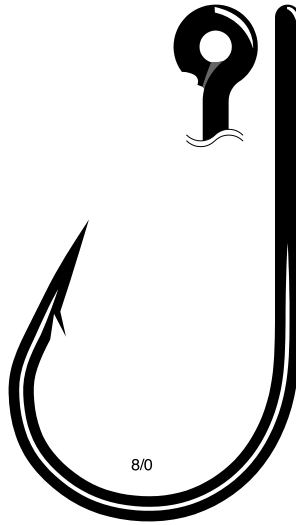



ASSIST HOOKS

Spinnakatsu[®]

Double Assist 520

New vertical jigging techniques like “slow pitch” and “shore” jigging are gaining attention at a rapid rate. Many of the top anglers are using two assist hooks instead of one. Think about it, you’re doubling your odds of hooking short or soft biters. Gamakatsu’s Double Assist hooks are designed for fast and easy replacement on all types of butterfly, flat fall and “iron” jigs. The 6” super strong braided line loop can be adjusted to position each hook at the exact desired length, even or offset. Red heat shrink tubing on the hook shank is an added attractor and prevents chafing and bite-offs. And there’s no concern of knots coming undone. Hooks are forged and barbed. Available in 2/0 and 4/0 in packages of two.

| SIZES | | 2/0 | 4/0 |
|-------|----|-----------|-----------|
| Tin | LS | 368512(2) | 368514(2) |

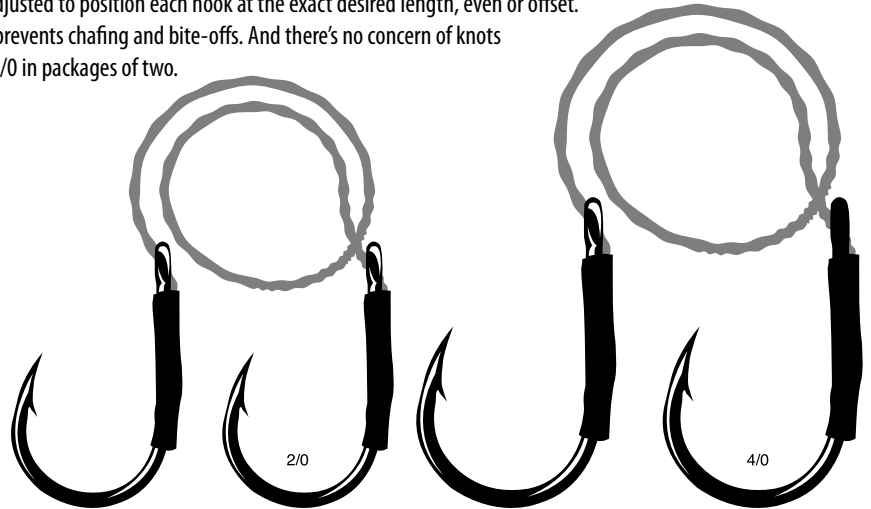
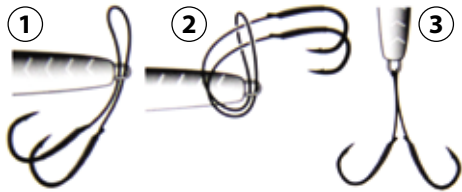

Assist 560 Double

If fishing smaller profile jigs is your thing, check out the new Assist 560 Double. The smaller size minimizes fouling on light tackle and micro jigging applications. When the bass go deep, rig up your favorite jig with the 560 Double to up the catch rates with lethargic biters.

| SIZES | | 2 | 1 | 1/0 |
|-------|----|-----------|-----------|-----------|
| Tin | LS | 428509(2) | 428510(2) | 428511(2) |

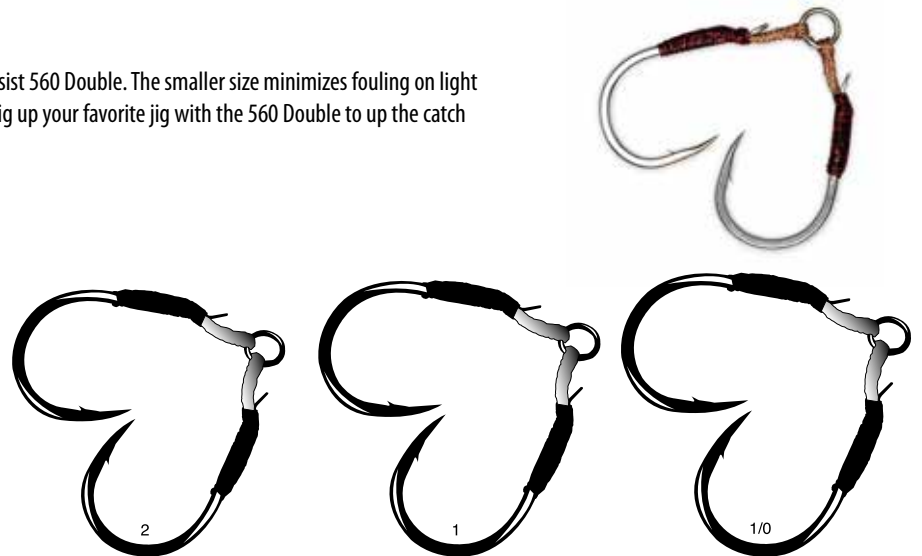

Assist 540 Double Bait Plus

For light tackle, micro jigging in saltwater, and vertical jig fishing for bass, Gamakatsu developed the new Assist 540 Double Bait Plus. For added attraction, Gamakatsu utilized a fish skin dressing. Each flashes just like your favorite sabiki rig, drawing strikes from the most reluctant fish. The leader is shorter on one side to increase visibility of each hook for maximum drawing power. This also further decreases the possibility of tangles, even with the most vigorous jigging techniques.

| SIZES | | 2 | 1 | 1/0 |
|-------|----|-----------|-----------|-----------|
| Tin | LS | 427509(2) | 427510(2) | 427511(2) |

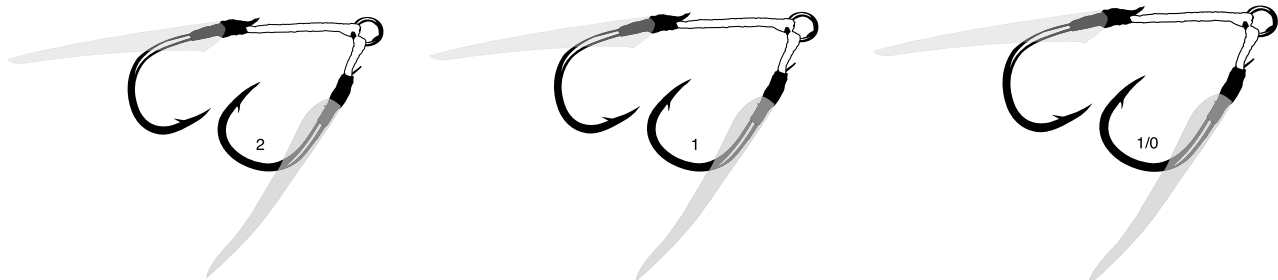

Assist 700 Double NSC

If you're targeting larger fish, outfit your jigs with the Assist 700 Double. This rig doubles up on the standard slow pitch assist hooks to maximize hookups. Gamakatsu also applied their Nano Smooth Coat to the hooks; this super slick coating reduces resistance for deeper penetration.

| SIZES | | 3/0 | 4/0 | 5/0 |
|------------------|----|-----------|-----------|-----------|
| Nano Smooth Coat | LS | 425213(2) | 425214(2) | 425215(2) |



FORGED



BARB

NANO SMOOTH COAT



Assist 530 Double Short and Double Long

The new Assist 530 Double comes in both long and short versions to suit various jig lengths. The polyethylene braided line features a fluorocarbon core making it stiffer, which reduces tangles and promotes deeper penetration when a fish is hooked.

| SIZES | | 1/0 | 2/0 | 3/0 |
|-----------|----|-------------|-------------|-------------|
| Tin SHORT | LS | 426511-S(2) | 426512-S(2) | 426513-S(2) |

Short Braided Line Length - 1 inch

| SIZES | | 1/0 | 2/0 | 3/0 |
|----------|----|-------------|-------------|-------------|
| Tin LONG | LS | 426511-L(2) | 426512-L(2) | 426513-L(2) |

Long Braided Line Length - 1.375 inch

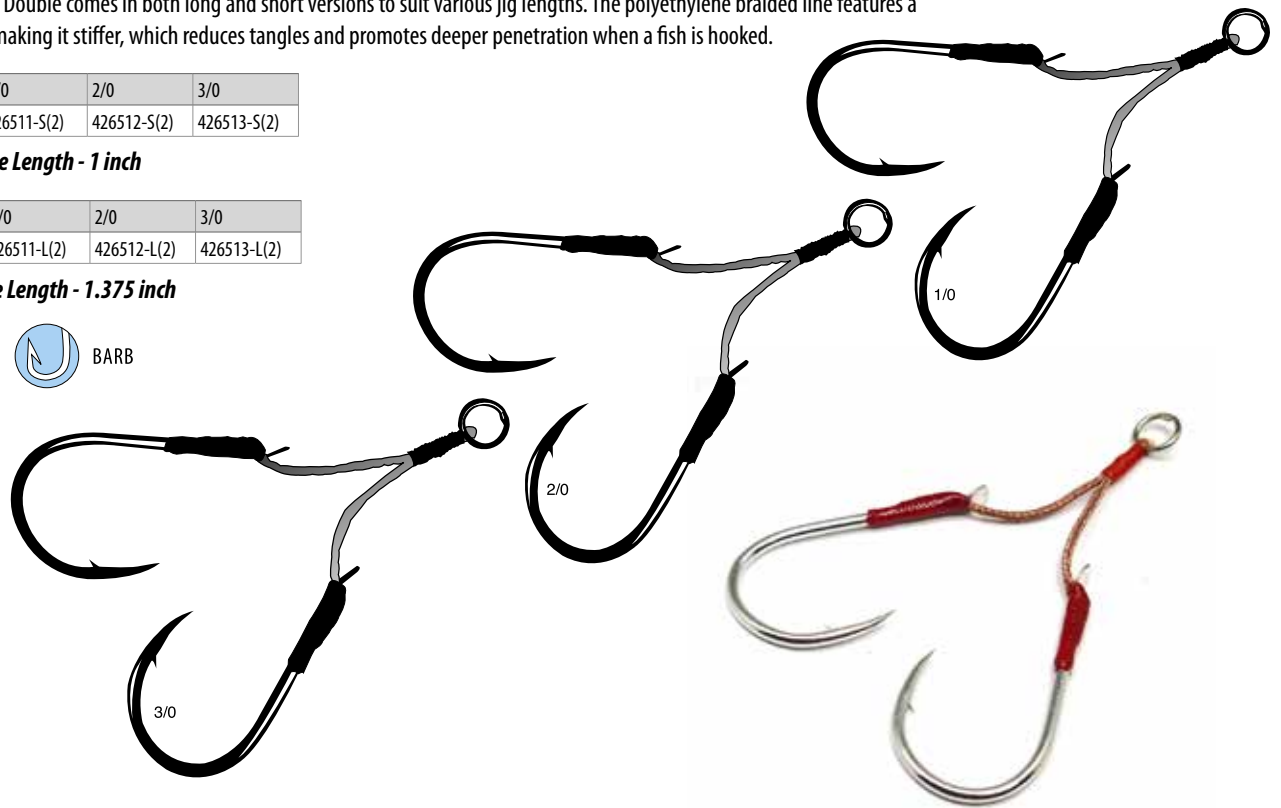

Assist Kinkai MS-Neo Double Short and Double Long

Compact and dependable, the Kinkai MS-Neo Double Short features a standard jigging hook with a long shank and inward-facing tip for maximum penetration. The “partial flat strike” preserves a round profile on the shaft’s contact point for solid hooksets. Reinforced with shrink tube and paired with high-visibility Blue Assist Line 480, it’s ideal for coastal jigging applications.

| Sizes | | 6/0 | 7/0 |
|-----------|----|-------------|-------------|
| Tin SHORT | LS | 477516-S(2) | 477517-S(2) |

Short Braided Line Length - 1 inch

PE Line Test: 100# (6/0), 120# (7/0)

| SIZES | | 6/0 | 7/0 |
|----------|----|-------------|-------------|
| Tin LONG | LS | 477516-L(2) | 477517-L(2) |

Long Braided Line Length - 1.25 inch

PE Line Test: 100# (6/0), 120# (7/0)



Assist Vertical Limit Short and Vertical Limit Long

Built for serious offshore jigging, the Assist Vertical Limit Short and Vertical Limite Long features a wide-gap, solid ring design paired with an extra-long needle point for superior hook-up rates. Finished with a corrosion-resistant tin coating and a micro-shrink tube at the base, this assist hook is built to withstand heavy use. Rigged with Blue Assist Line 480—a unique color-tuned line visible in the 480nm underwater spectrum—it enhances the overall silhouette for greater fish attraction. Ideal for flat fall or metal jigs targeting species like Yellowfin Tuna.

| Sizes | | 5/0 | 6/0 | 7/0 |
|-----------|----|-------------|-------------|-------------|
| Tin SHORT | LS | 479515-S(3) | 479516-S(2) | 479517-S(2) |

Short Braided Line Length - 1.37 inch

PE Line Test: 175#

| SIZES | | 5/0 | 6/0 | 7/0 |
|----------|----|-------------|-------------|-------------|
| Tin LONG | LS | 479515-L(3) | 479516-L(2) | 479517-L(2) |

Long Braided Line Length - 1.57 inch

PE Line Test: 175#



Assist Tsuranuki

Designed for power jigging and long, hard fights, the Assist Tsuranuki is built around a custom retainer-bend hook based on the classic Tuned Tuna style. A beak point wide gap design with micro barb provides excellent penetration, this assist hook excels in both deep water and repetitive hookset situations. Finished with tin coating, a solid ring, and Blue Assist Line 480, it's a rugged solution for nearshore and offshore species like Yellowfin Tuna.

| Sizes | | 5/0 | 6/0 |
|-----------|----|-----------|-----------|
| Tin SHORT | LS | 480515(2) | 480516(2) |

Braided Line Length - 1.50 inch

PE Line Test: 175#



Pluggin' Single HD- Assist

Built for serious saltwater plugging, the Gamakatsu Pluggin' Single HD-Assist delivers heavy-duty strength and maximum hookup efficiency in a streamlined assist configuration. Featuring a premium braided assist cord and solid ring connection for enhanced freedom of movement, it reduces leverage during the fight while improving hook retention and lure action. Finished with a razor-sharp, forged point and corrosion-resistant construction, it's designed to handle powerful gamefish and serve as a high-performance alternative to traditional trebles.

| SIZES | | 7/0 | 8/0 | 9/0 | 10/0 | 11/0 |
|-------|----|-----------|-----------|-----------|-----------|-----------|
| Tin | LS | 492517(2) | 492518(2) | 492519(2) | 492520(2) | 492521(2) |



FORGED



BARB

NEW

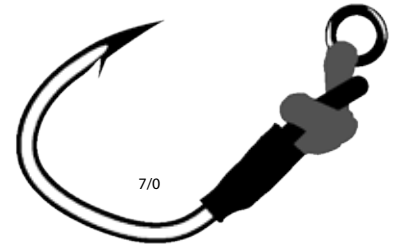

7/0

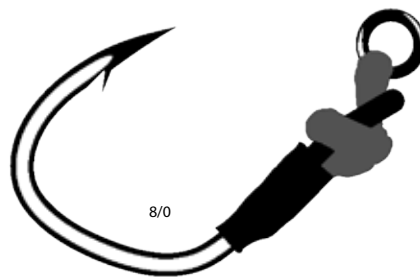

8/0

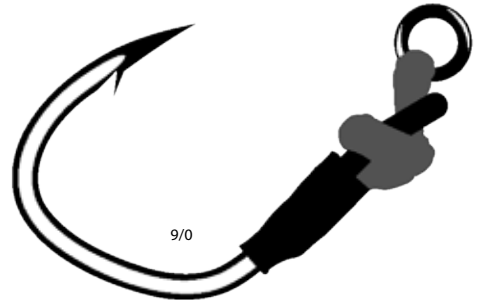

9/0

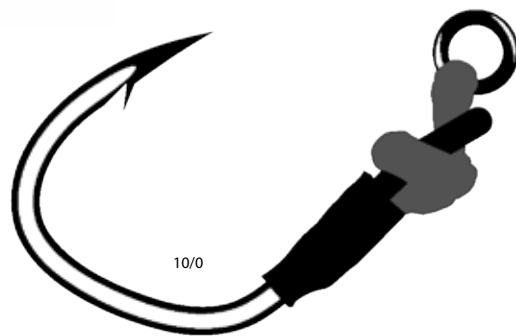

10/0

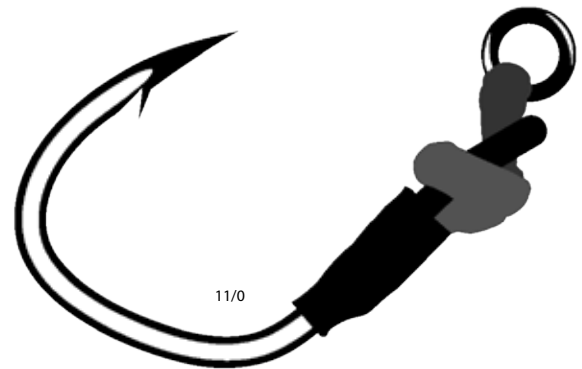

11/0

Assist 510

The Assist 510 features a curved point with an outbarb that will not nick the leader if it were to catch the line. No vertical jig should be fished without one. The super strong braided line loop easily attaches to any jig. One of the first Assist hooks introduced in this country and still the best designed.

| SIZES | | 1/0 | 2/0 | 3/0 | 4/0 |
|-------|----|-----------|-----------|-----------|-----------|
| Tin | LS | 219511(4) | 219512(3) | 219513(3) | 219514(2) |



FORGED



OUT-BARB

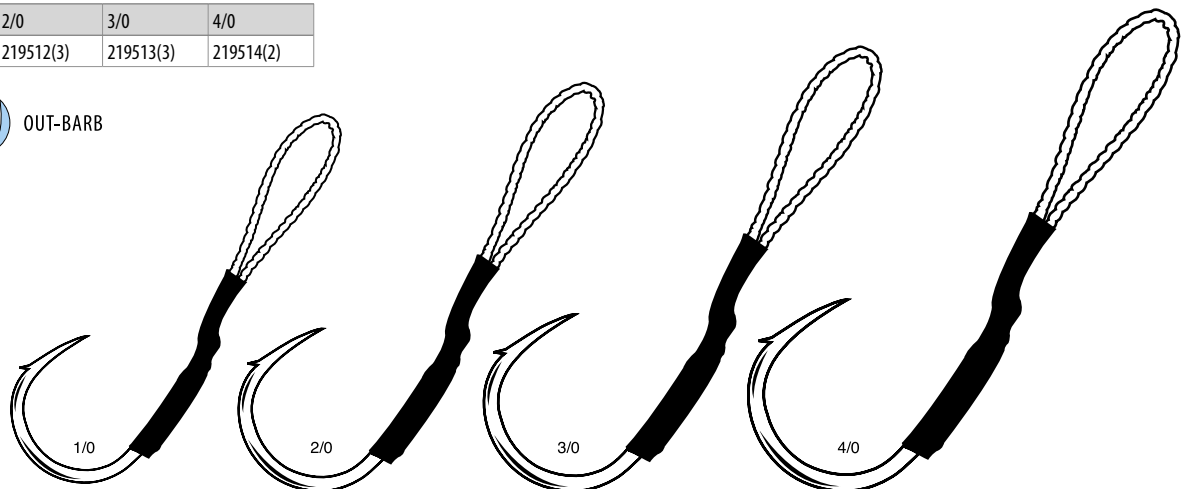

1/0

2/0

3/0

4/0

Assist 550 Short

The new Assist 550 Short provides the brawn needed to land pelagic gamefish on lures typically reserved for inshore species. Unlike the long metal shanks on treble hooks, the flexible leader doesn't act like a lever to give fish a mechanical advantage that can defeat even the stoutest hook hangers. You can replace light-wire trebles with the heavier duty Assist 550 Short and retain the action that makes your favorite plug so effective

| SIZES | | 1 | 1/0 | 2/0 |
|-------|----|-----------|-----------|-----------|
| Tin | LS | 429510(2) | 429511(2) | 429512(2) |

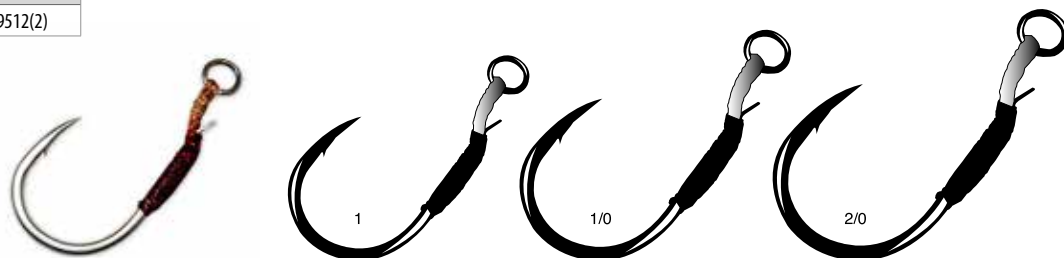

Tuned Assist HD

This addition to our Assist hook line up is for deep jigging and big fish. These heavy duty assist hooks come in two sizes, 8/0 and 10/0 with 270lb braided line. Both feature a solid ring at the top for easy and secure attachment to the jig.

| SIZES | | 8/0 | 10/0 |
|-------|----|-----------|-----------|
| Tin | LS | 270518(1) | 270520(1) |

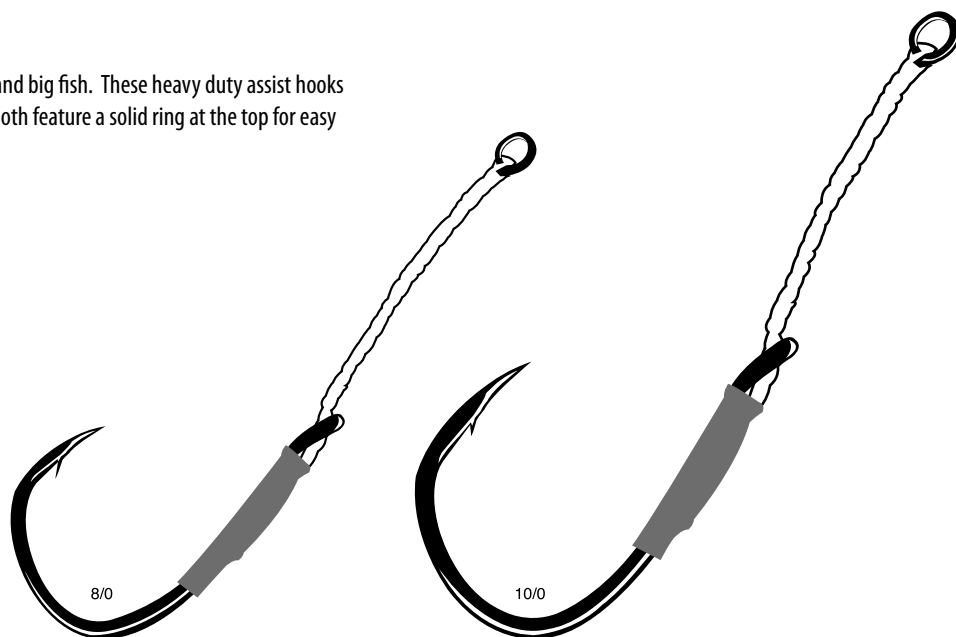

Magnum Assist

Featuring a 200lb. braided line loop and our 4x Strong Octopus hook in 8/0 and 10/0, the Magnum Assist is perfect for larger Halibut jigs and deep drop speed jigs.

| SIZES | | 8/0 | 10/0 |
|----------|----|-----------|-----------|
| NS Black | LS | 256418(2) | 256420(2) |

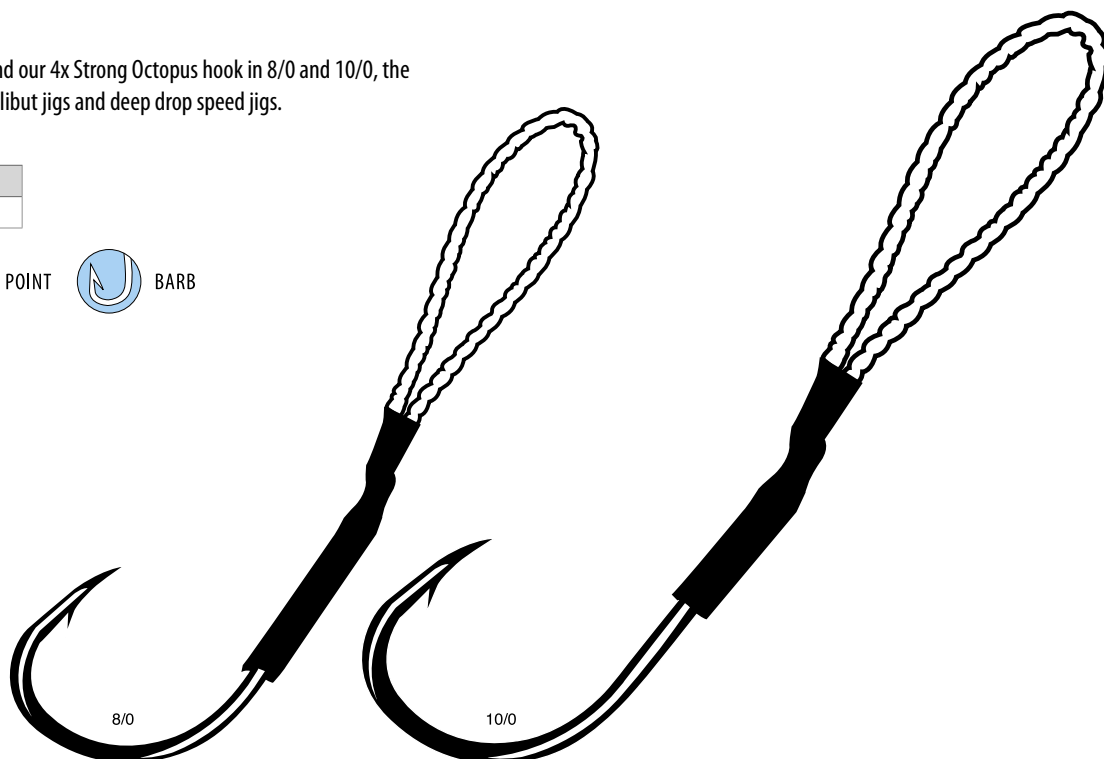
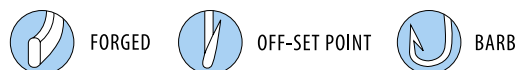

Steel Assist with Magic Eye Swivel

Don't sacrifice your favorite jig to toothy fish like Wahoo and Mackerel. This Assist Hook features our Magic Eye Swivel for fast and easy attachment to the split ring on any jig. No pliers needed. 90lb. wire and a 4x Strong Straight Eye Octopus hook make this the ultimate big game, toothy fish Assist hook. Comes in a 3/0 short version and 5/0 long version for bigger jigs.

| SIZES | | 3/0 | 5/0 |
|----------|----|-----------|-----------|
| NS Black | LS | 269413(2) | 269415(2) |

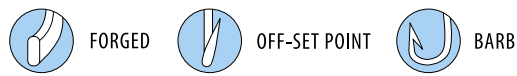

Assist 520, Ringed

In our relentless pursuit of perfection, and simplicity, we added a welded ring to our tournament-winning Assist 520 hook. The constant jigging motion is tough on looped monofilament, fluorocarbon, and braid. We took every nuance of uncertainty out of the technique by adding a welded ring. Not only is it nearly unbreakable, but the ring is also much faster and easier to connect to the jig eye using a split ring. *Rigged with 160 lb. (3/0, 4/0) and 220 lb. (5/0, 6/0) braided line.*

| SIZES | | 4/0 | 5/0 | 6/0 |
|-------|----|-----------|-----------|-----------|
| Tin | LS | 380514(2) | 380515(2) | 380516(2) |

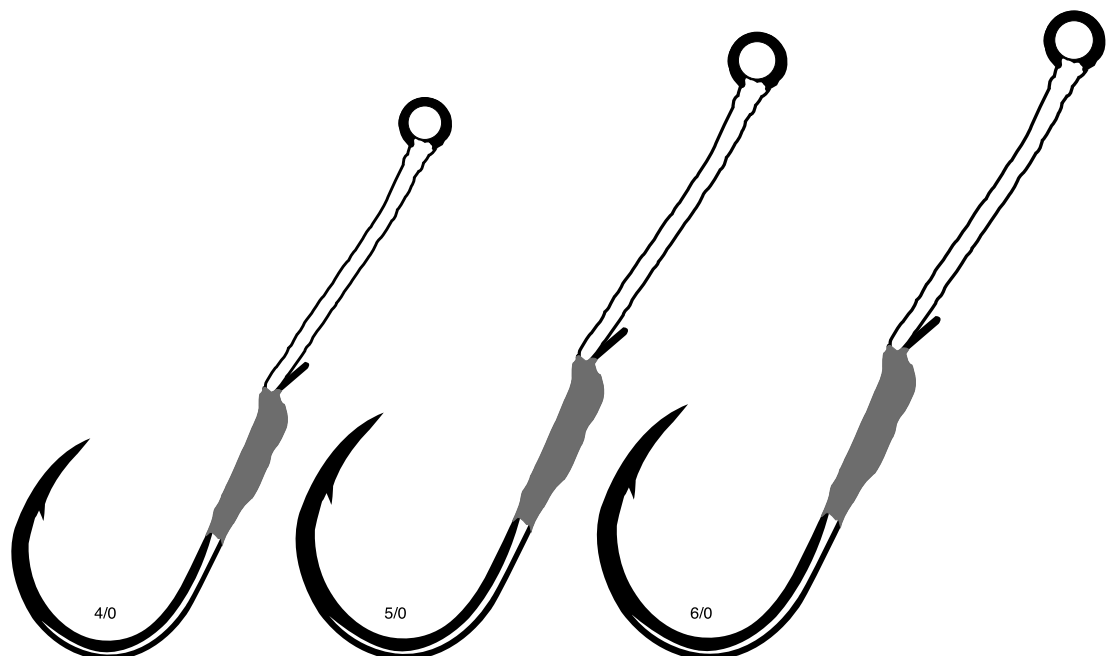

Assist 620 Heavy Duty with Solid Ring

When you pursue the fish of a lifetime, chances are it's going to be really, really big; and have really, really, really sharp teeth. Take no chances! We call these "heavy-duty" Assist 620 hooks but they'll live up to tenacious-duty, gargantuan-duty or leviathan-duty equally as well. There's nothing stronger. One-piece solid rings make connections easy. Rigged with 270 lb. (5/0, 6/0) and 400 lb. (7/0, 8/0) braided line.

| SIZES | | 5/0 | 6/0 | 7/0 |
|-------------|----|-----------|-----------|-----------|
| Hypershield | LS | 381515(1) | 381516(1) | 381517(1) |

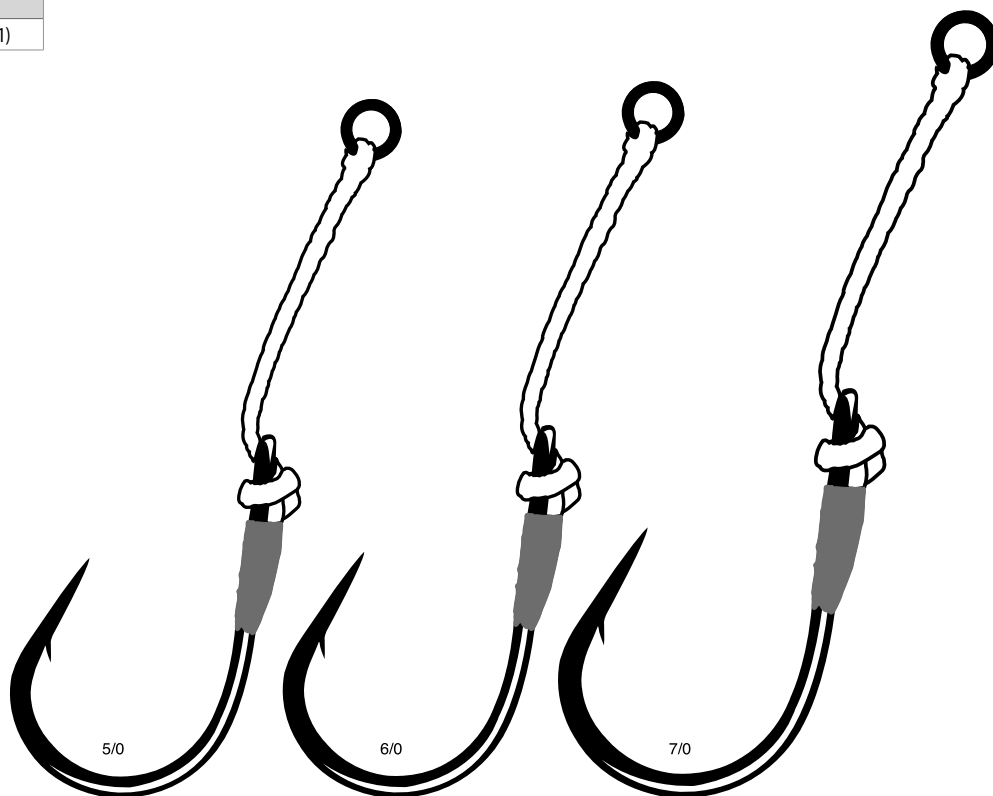

Assist 720 Heavy Duty

Gamakatsu calls the Assist 720 hooks "heavy-duty," but that's an understatement with these bruisers! Gamakatsu's Assist 720 Heavy Duty is the ultimate in big game fish rigging and uses an ultra-strong, incredibly sharp Gamakatsu saltwater hook. A four-strand braid of abrasion-resistant polyethylene cord provides a whopping 880-lb combined test strength, while the ring makes it fast and easy to connect the assist hook to the jig eye using a split ring.

| SIZES | | 10/0 | 11/0 | 12/0 |
|-------|----|-----------|-----------|-----------|
| Tin | LS | 395520(1) | 395521(1) | 395522(1) |

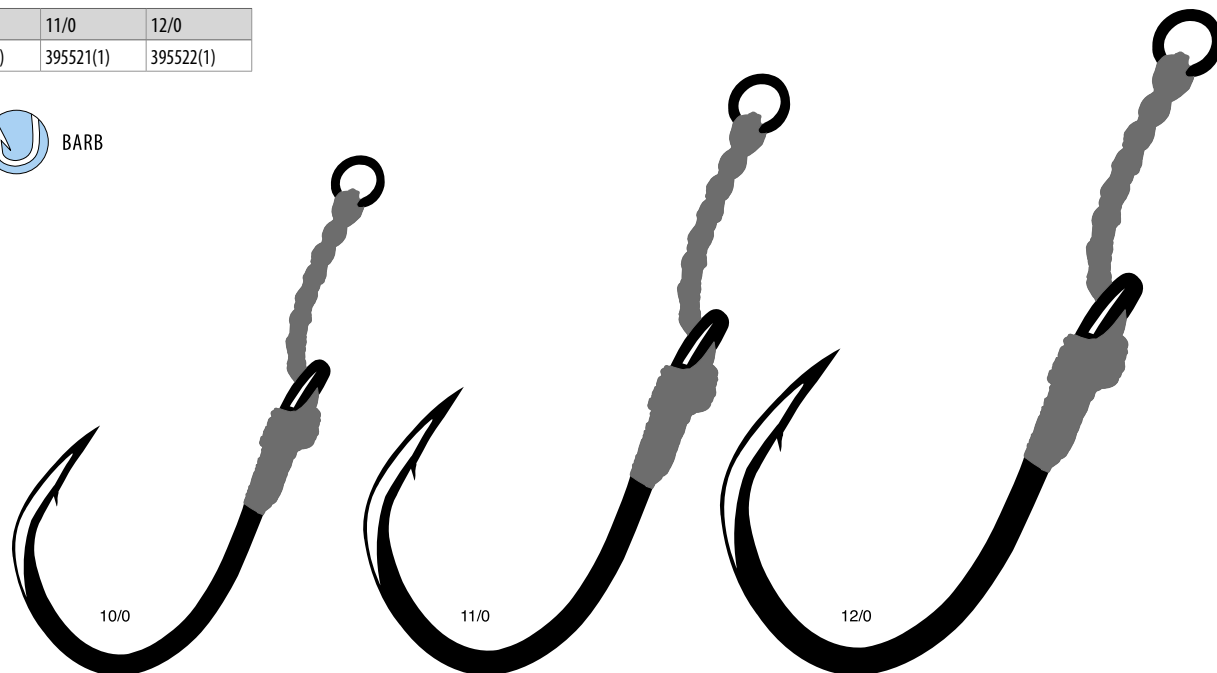





RIGS AND SNELLS

Spinnakätsu[®]

Drop Shot Rig

Each leader is 6' long with the hook tied in the middle using high quality clear monofilament.

| | | | |
|-----------|--------------|--------------|--------------|
| Hook Size | 4 | 2 | 1 |
| Line Size | 6 | 8 | 8 |
| NS Black | 214408-06(3) | 214409-08(3) | 214410-08(3) |

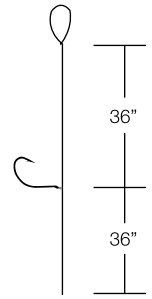

Single Egg Hooks, Barb On Shank Snell

A premier bait hook for salmon eggs. Also great for floating dough baits.

| SIZES | | 14 | 12 | 10 | 8 | 6 |
|-------|-----|-----------|-----------|-----------|-----------|-----------|
| Red | LS | 04303(10) | 04304(10) | 04305(10) | 04306(10) | 04307(10) |
| | SNL | 04803(10) | 04804(10) | 04805(10) | 04806(10) | 04807(10) |
| Gold | LS | 04203(10) | 04204(10) | 04205(10) | 04206(10) | 04207(10) |
| | SNL | | 04704(10) | 04705(10) | 04706(10) | 04707(10) |

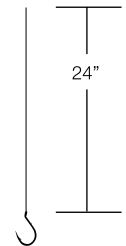

Baitholder Snell

The ever popular Baitholder hook available in pre packed snells.

| SIZES | | 14 | 12 | 10 | 8 | 6 | 4 | 2 | 1 |
|--------|-----|-----------|-----------|-----------|-----------|-----------|-----------|-----------|-----------|
| Bronze | LS | | 05104(10) | 05105(10) | 05106(10) | 05107(10) | 05108(10) | 05109(8) | 05110(8) |
| | 100 | | 05104-100 | 05105-100 | 05106-100 | 05107-100 | 05108-100 | 05109-100 | 05110-100 |
| | SNL | 05603(10) | 05604(10) | 05605(10) | 05606(10) | 05607(10) | 05608(10) | 05609(8) | 05610(8) |

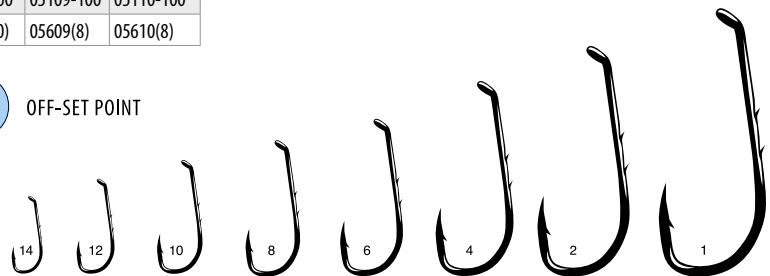

Kokanee Two Hook Snell

The Kokanee Two Hook Snell rigs are geared for chasing kokanee and other freshwater species like walleye and trout. The fluorescent colored octopus hooks used on the rigs add an attractant and are pre-tied on 6' of premium Japanese monofilament. Anglers can use these pre-tied rigs straight out of the package and customize as desired with blades and beads or your favorite hoochie rig combinations.

| Color | Hook Size | Line(LB) | Stock# |
|--------------|-----------|----------|--------------|
| Red | 4 | 12 | 415308(3) |
| F-Red | 4 | 12 | 415608-FR(3) |
| Chartreuse | 4 | 12 | 415608-C(3) |
| F-Pink | 4 | 12 | 415608-P(3) |
| F-Orange | 4 | 12 | 415608-OR(3) |
| F-Purple | 4 | 12 | 415608-PU(3) |
| Ultra Violet | 4 | 12 | 415608-UV(3) |
| Glow | 4 | 12 | 415608-GL(3) |



EWG Walleye Snell

Red wide gap baitholder hook with 7 feet of premium clear 8 lb. monofilament. A molded glow bead secures and covers the snell for extra knot strength and added attraction. *Three rigs per pack.*

| Hook Size | Line (LB) | Stock # |
|-----------|-----------|--------------|
| 6 | 8 | 228307-08(3) |
| 4 | 8 | 228308-08(3) |
| 2 | 8 | 228309-08(3) |



Walleye Snell with Glowbead

Our Walleye Snell blends all of the premium components walleye anglers have come to expect from the premium hook leader. Featuring our sticky sharp Octopus hook in the most popular walleye catching colors. All tied on a 7' premium Japanese 8 lb. monofilament.

| SIZES | 6-08 | 4-08 | 2-08 |
|------------|-----------------|-----------------|-----------------|
| F-Red | 297607-FR-08(5) | 297608-FR-08(5) | 297609-FR-08(5) |
| Chartreuse | 297607-C-08(5) | 297608-C-08(5) | 297609-C-08(5) |
| F-Pink | 297607-P-08(5) | 297608-P-08(5) | 297609-P-08(5) |
| F-Orange | 297607-OR-08(5) | 297608-OR-08(5) | 297609-OR-08(5) |
| Glow | 297607-GL-08(5) | 297608-GL-08(5) | 297609-GL-08(5) |
| Red | 297607-R-08(5) | 297608-R-08(5) | 297609-R-08(5) |



Walleye LG Two Hook Rig

Two hook rig with adjustable top hook. Includes glowbead and tube.

| Hook Size | 6 | 4 |
|-----------|------------------|---------------|
| Line Size | 8 | 5 |
| Red | LS 278307-08(10) | 278308-10(10) |

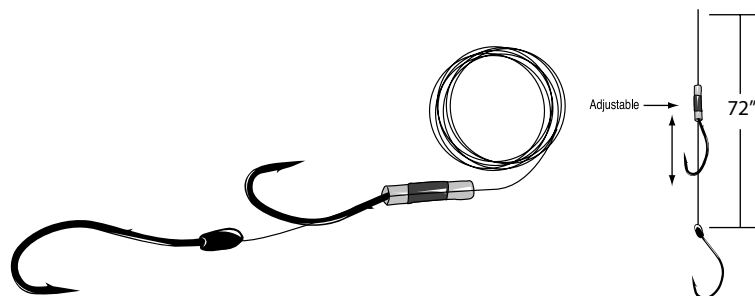

Treble Stinger Rig, Wire Leader

It's widely known that trailing stinger rigs are the ticket for catching short-biting walleyes when jigging in cold water conditions. For years, seasoned anglers have painstakingly tied their own stinger rigs using premium Gamakatsu hooks. Now, we've done all the work for you. Gamakatsu Treble Hook Stinger Rigs are 100% ready to use and will outlast most others on the market. A coated steel wire is machine crimped and then dipped in a durable rubberized coating; allowing it to hang perfectly behind your jig or bait. And since they're connected to a premium Gamakatsu treble hook, they'll stay sticky sharp, fish after fish, after fish. Save time. Save money. Keep fishing longer with Gamakatsu Treble Hook Stinger Rigs.

| Hook Size | 12 | 10 | 8 | 6 |
|-----------|-----------|-----------|-----------|-----------|
| NS Black | 364404(3) | 364405(3) | 364406(3) | 364407(3) |



Treble Stinger Rig, Fluorocarbon Leader

Bass and walleye will certainly grab hold of this stealthier version of our trailing stinger rig. We've pre-tied two inches of premium, 16-pound test fluorocarbon line instead of the coated steel wire. It works well with a wide variety of baits; however, it is most suited for trolling baits or any scenarios where fish are coming from behind and just striking the tail of the bait. Many anglers consider it mandatory for cold weather angling when fish are sluggish.

| Hook Size | 12 | 10 | 8 |
|-----------|-----------|-----------|-----------|
| Red | 378304(3) | 378305(3) | 378306(3) |

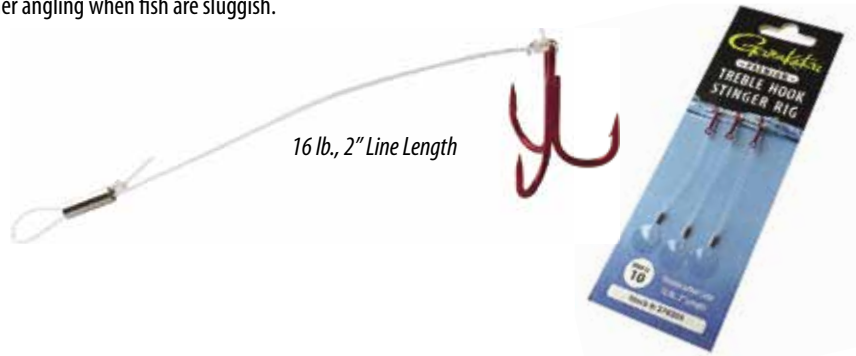

Catfish Rig

The new Catfish Rigs are pre-tied and ready to fish. Both rigs are tied with 28" of 50 lb. premium Japanese monofilament and a SPRO Power Swivel.

| SIZES | 5/0 | 6/0 | 7/0 | 8/0 |
|----------|--------------|--------------|--------------|--------------|
| NS Black | 299415-50(2) | 299416-50(2) | 299417-50(2) | 299418-50(2) |

- EYE
- FORGED
- BARB
- OFF-SET POINT

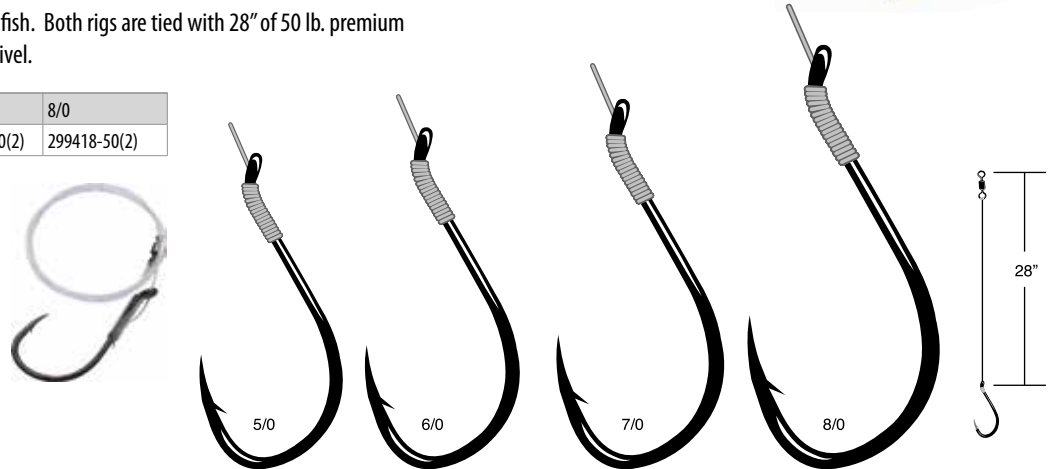

Catfish Rig Circle

| SIZES | 5/0 | 6/0 | 7/0 | 8/0 |
|----------|--------------|--------------|--------------|--------------|
| NS Black | 300415-50(2) | 300416-50(2) | 300417-50(2) | 300418-50(2) |

- EYE
- FORGED
- BARB
- OFF-SET POINT
- CIRCLE HOOK

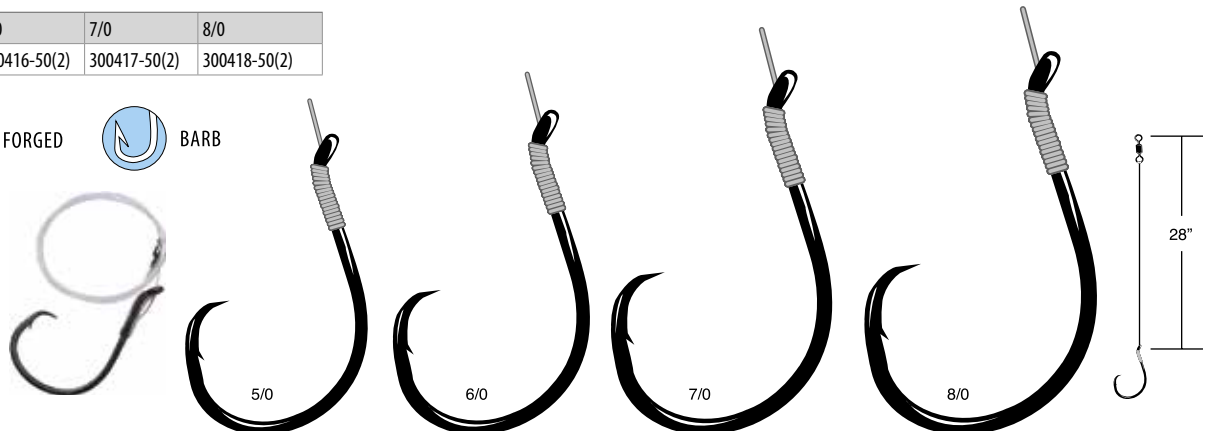

Mooching Rig (Slip Tie) "3 individually packed leaders, 6 ft. rig."

| Line (LB.) | Hook Size | Nickel |
|------------|-----------|--------------|
| 20 | 2/0, 3/0 | 215023-20(3) |
| 20 | 3/0, 4/0 | 215034-20(3) |
| 25 | 2/0, 3/0 | 215023-25(3) |
| 25 | 3/0, 4/0 | 215034-25(3) |
| 30 | 3/0, 4/0 | 215034-30(3) |
| 30 | 4/0, 5/0 | 215045-30(3) |
| 30 | 5/0, 6/0 | 215056-30(3) |
| 40 | 4/0, 5/0 | 215045-40(3) |
| 40 | 5/0, 6/0 | 215056-40(3) |

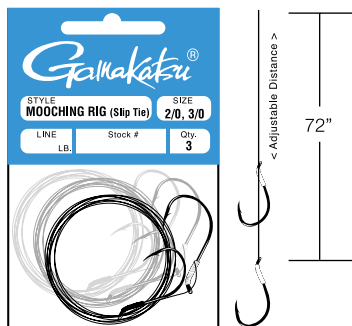

Mooching Rig (Solid Tie) "3 individually packed leaders, 6 ft. rig."

| Line (LB.) | Hook Size | Stock# |
|------------|-----------|--------------|
| 15 | 3/0, 4/0 | 218034-15(3) |
| 20 | 2/0, 3/0 | 218023-20(3) |
| 20 | 3/0, 4/0 | 218034-20(3) |
| 25 | 2/0, 3/0 | 218023-25(3) |
| 25 | 3/0, 4/0 | 218034-25(3) |
| 30 | 3/0, 4/0 | 218034-30(3) |
| 30 | 4/0, 5/0 | 218045-30(3) |
| 30 | 5/0, 6/0 | 218056-30(3) |
| 40 | 4/0, 5/0 | 218045-40(3) |
| 40 | 5/0, 6/0 | 218056-40(3) |

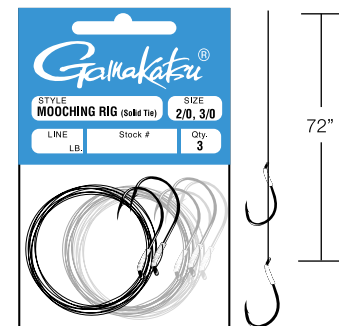

Mooching Rig (Slip Tie) Barbless

As barbless hook regulations expand, Gamakatsu has met the challenge with a better designed, sharper and stronger Barbless Octopus hook. Designed expressly for the application, Gamakatsu's Barbless Octopus hooks feature a slightly wider gap that provides better fish-holding benefits than traditional barbed Octopus hooks. These hooks comply with state regulations requiring "barbless hooks". Proven effective for a variety of species, Gamakatsu's Barbless hooks are now available in pre-tied mooching rigs. Tied on premium monofilament line with 6 foot leaders, Gamakatsu Barbless Mooching Rigs are packaged individually. "3 individually packed leaders, 6 ft. rig!"

| Line (LB) | Hook Size | Nickel |
|-----------|-----------|--------------|
| 25 | 3/0, 4/0 | 337034-25(3) |
| 30 | 3/0, 4/0 | 337034-30(3) |
| 30 | 4/0, 5/0 | 337045-30(3) |
| 30 | 5/0, 6/0 | 337056-30(3) |
| 40 | 4/0, 5/0 | 337045-40(3) |
| 40 | 5/0, 6/0 | 337056-40(3) |



Mooching Rig Big River Bait (Slip Tie)

The innovative design of the Big River Hook has gained popularity from coast to coast. It's unique acute bend is designed to hold fish tight once hooked. The rigs are slip tied to adjust to various sized baits and are pre-tied on 6' of premium Japanese monofilament. Anglers can use these pre-tied rigs straight out of the package for all mooching and trolling applications.

| Line (LB.) | Hook Size | Stock# |
|------------|-----------|--------------|
| 30 | 3/0 | 414413-30(3) |
| 30 | 4/0 | 414414-30(3) |
| 40 | 4/0 | 414414-40(3) |
| 40 | 5/0 | 414415-40(3) |

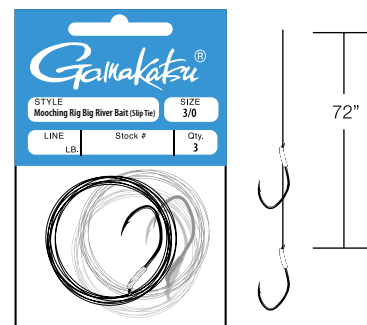

Two Hook Bait Rig

Two red hooks snelled about 1 inch apart to 6 ft piece of premium monofilament. Perfect for fishing salmon egg clusters. "3 rigs per pack!"

| Hook Size | Line (LB) | Stock # |
|-----------|-----------|--------------|
| 3/0, 4/0 | 25 | 233334-25(3) |
| 3/0, 4/0 | 30 | 233334-30(3) |
| 4/0, 5/0 | 30 | 233345-30(3) |
| 5/0, 6/0 | 30 | 233356-30(3) |
| 4/0, 5/0 | 40 | 233345-40(3) |
| 5/0, 6/0 | 40 | 233356-40(3) |
| 6/0, 7/0 | 40 | 233367-40(3) |



Salmon/Steelhead Leader

"3 individually packed leaders, 6 ft rig!"

| Line (LB.) | Hook Size | Stock# |
|------------|-----------|--------------|
| 8 | 2 | 217309-08(3) |
| 8 | 1 | 217310-08(3) |
| 10 | 1 | 217310-10(3) |
| 10 | 1/0 | 217311-10(3) |
| 12 | 1/0 | 217311-12(3) |
| 12 | 2/0 | 217312-12(3) |
| 15 | 2/0 | 217312-15(3) |
| 20 | 3/0 | 217313-20(3) |
| 30 | 3/0 | 217313-30(3) |
| 30 | 4/0 | 217314-30(3) |
| 40 | 4/0 | 217314-40(3) |
| 30 | 5/0 | 217315-30(3) |
| 40 | 5/0 | 217315-40(3) |

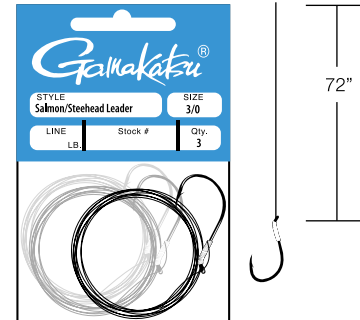

Sockeye Rig

When the sockeye start running, you better be ready to get in the game fast. With our Sockeye Rigs, you are geared up in seconds. Tied on 30 lbs. leaders with sticky sharp 3/0 red Octopus hooks, available in 2 colors - chartreuse or flame red. Nothing is easier or faster, except maybe your limit. We've done the work for you to maximize your time on the water.

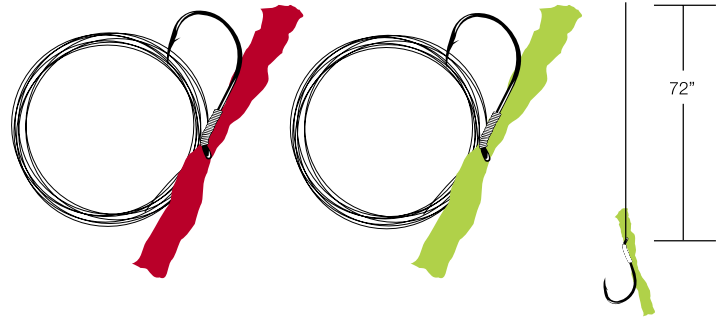

| Hook Size | Line (lb) | Stock # |
|----------------|-----------|-----------------|
| 3/0 Chartreuse | 30 | 372313-C-30(3) |
| 3/0 Flame Red | 30 | 372313-FR-30(3) |

French Hook Snell

The Gamakatsu French Hook Snell comes in red or bronze color, to add a little bit of extra attraction to any bait. Each of the five hook sizes are pre-tied to 24 inches of high-quality Japanese monofilament line of a suitable pound test for the hook size. As anglers would expect, these are rigged with premium Gamakatsu hooks. The Gamakatsu French Snell Rig will work for anything from trout to walleye, with a variety of live or artificial baits.

| SIZES | | 10 (6 lb) | 8 (6 lb) | 6 (8 lb) | 4 (8 lb) | 2 (10 lb) |
|--------|-----|-------------|-------------|-------------|-------------|-------------|
| Bronze | SNL | 413605 (10) | 413606 (10) | 413607 (10) | 413608 (10) | 413609 (10) |
| Red | SNL | 413805 (10) | 413806 (10) | 413807 (10) | 413808 (10) | 413809 (10) |

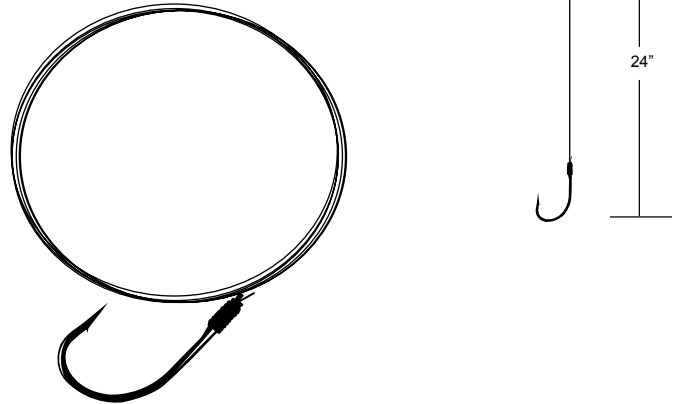

Top And Bottom Rig

Designed primarily for bottom fishing, this rig uses two size 2 NS Black Baitholder hooks attached to a 40lb. leader so they stick out about 4" from the main line and are spaced about 10" apart. It includes a barrel swivel at the top of the rig and a cross lock for easy weight attachment at the bottom.

| Hook Size | Line (lb) | Stock # |
|-----------|-----------|-----------|
| 2 | 30 | 238409(1) |

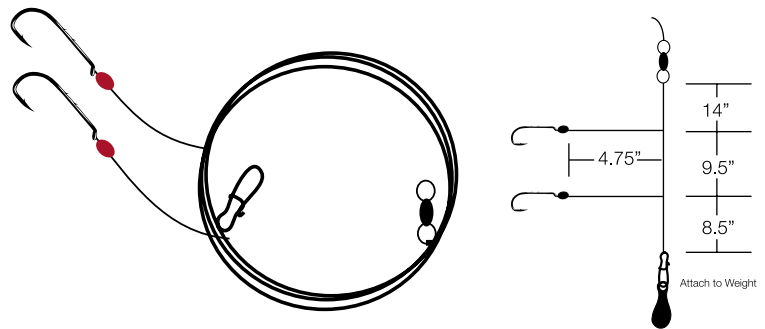

Striper Rig

Striper fishermen are a demanding group. Striper anglers have asked for a dependable pre-tied rig to meet their needs and Gamakatsu has answered. The Striper Rig features a proven Octopus hook, tied on 28" of premium 40 lb. monofilament. The rig also includes a high quality #4 Gamakatsu barrel swivel rated at 130 lb. This rig is sure to give any striper fisherman the confidence they need to catch that trophy of a lifetime.

| Hook Sizes | 4/0 | 5/0 | 6/0 | 7/0 | 8/0 |
|------------|--------------|--------------|--------------|--------------|--------------|
| NS Black | 305414-40(2) | 305415-40(2) | 305416-40(2) | 305417-40(2) | 305418-40(2) |



Striper Rig With Sliding Sinker Lock

This rig features a 5/0 NS Black Baitholder hook snelled to a 80 lb. clear leader with a 100 lb. barrel swivel and a sliding sinker lock that goes on the main line above the swivel.

| Hook Size | Line (lb) | Stock # |
|-----------|-----------|-----------|
| 5/0 | 80 | 241415(2) |

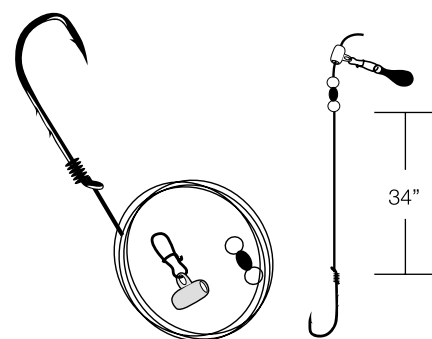

Jigging Rig, Gold

| SIZES | | 8 | 6 | 4 |
|-----------|-----|----------|----------|----------|
| Fish Skin | Rig | 64306(1) | 64307(1) | 64308(1) |

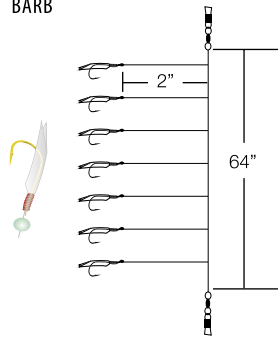

Jigging Rig, Nickel, Smelt/Herring

| SIZES | | 5 | 4 |
|-----------|-----|----------|----------|
| Fish Skin | Rig | 58108(1) | 58109(1) |

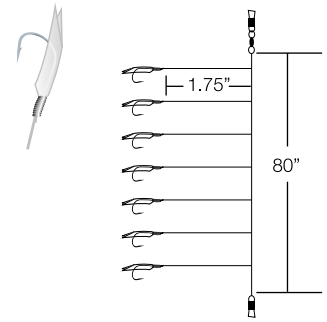

Jigging Rig, Special Assorted Hook

| SIZES | | 5 |
|-----------|-----|--------------------------------------|
| Fish Skin | Rig | 207307 (Gold, Nickel, Red, Green)(1) |

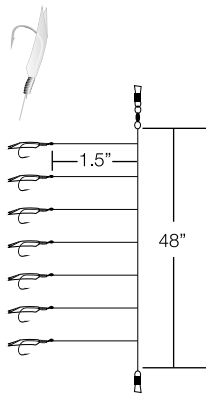

Jigging Rig, Special Weighted Assorted Hook

| SIZES | | 5 |
|-----------|-----|--------------------------|
| Fish Skin | Rig | 206307 (Gold, Nickel)(1) |

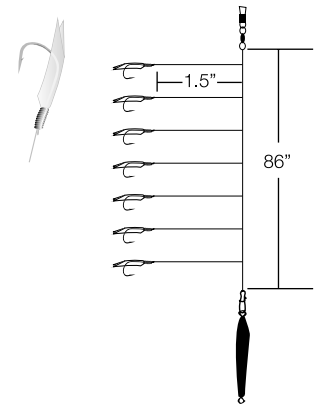



FLY HOOKS

Galakatsa[®]

FLY HOOK REPRESENTATIVES

Skip Gibson

5145 Bigelow Rd, Bozeman, MT. 59718
 Ph: 406-556-0822 Fx: 406-556-0823
 skipflyh20@aol.com
ID, WY, MT

Dan Marshall - Northwest Outdoor Sales

3409 140th St Ct NW, Gig Harbor, WA
 Ph: 800-445-8150 Fx: 253-445-8153
 flymandan1@yahoo.com
OR, WA, AK

Marty Holding - L H French Co

Ph: 801-302-8448 Cl: 801-580-7290
 Fx: 801-302-8449 mholding@lhfrench.com
UT, MT, Southern Idaho

Len Vinci - L H French Co

Ph: 916-543-8690 Cl: 916-718-3926
 Fx: 916-543-8698 lvinci@lhfrench.com
Northern CA, Northern NV

Peter Jordan - Grand Slam Group LLC

26343 Montelucia Way, Daphne, AL 36526
 Cl: 251-520-8975
AL, FL, GA, NC, SC

Tom Jindra - Grand Slam Group LLC

2501 Prancer St, New Orleans, LA 70131
 Ph: 504-392-7511 Fx: 504-324-1889
 tomjindra@cox.net | www.tomjindra.com
AR, LA, MS, TN, TX, OK

Tom Timmerberg

6604 Devonshire Ave 1 So, St Louis, MO 63109
 Ph: 314-255-3692 tomtimmerberg@hotmail.com
MO, KS, IL, MN, WI, IA

Ben Hunting

6777 Old Darby Trail NE, Ada, MI 49301
 Ph: 616-901-1926 benhunting@comcast.net
OH, MI, IN, KY

Gamakatsu has been making premium quality hooks since 1955. Every hook is made using Gamakatsu's own high quality, high carbon steel and is meticulously crafted to the highest of standards. Unlike other hook manufacturers, Gamakatsu hooks are made in their own facility which is one of the most technologically advanced in the world and their consistency is unmatched. What you'll find in this catalog are super sharp, super strong fly hooks made for the serious fly tyer and fly angler who will settle for nothing but the best. While an investment in a good fly rod, fly reel, fly line and the knowledge on how to properly use them can enhance the fly fishing experience, the hook is the one piece of equipment at the end of it all that has to hang on to the object of pursuit. Don't settle for anything less than Gamakatsu quality.

The Executive Series - The most advanced fly hook available.

Executive Series fly hooks offer some very unique designs like the R10B Retainer Bend and the C13U Keel Balance. Hooks like the S10 series of hooks have beak points that allow for effortless penetration, especially with light tippets and a slightly wider gap. They also have a shank length just a little longer than standard dry fly hooks. While the R10B and C13U are matte black, the B10S Stinger hooks and the rest of the Executive series have a beautiful NS Black finish that not only looks good, but is also very corrosion resistant. There's no other hook series like it.

- Corrosion Resistant NS Black Finish
- Beak Points
- Unique Designs



By Drew Chicone

Traditional Series - A necessity for patterns of time honored tradition.

The Traditional Series hooks are mostly all Bronze finished, have needle points, and are designed to match up in style and size with other popular hook brands. The key difference being the quality of the steel used in them and the sharpness of the hook. The Traditional Series hooks also feature the traditional Salmon/Steelhead tapered loop up eye hooks, but in non-traditional finishes like Red in addition to the traditional NS Black finish. The styles all match, but the quality is unmatched.

- Traditional Sizing
- Traditional Bronze Finish
- Gamakatsu Strength and Sharpness

**Saltwater Series - The most complete line of saltwater fly hooks.**

By far and away the finest selection of Saltwater fly hooks available. Multiple styles featuring our most popular SC15 and other hooks ranging in sizes from 18 to 10/0. The SC15 is used for many different patterns but is also a great hook for tube flies. The SP11-3L3H makes a great popper hook. There's a hook style for every saltwater application imaginable. Every Saltwater Series fly hook is made from the highest quality high carbon steel and has a durable tin plating or NS Black finish for corrosion resistance. Because of the steel used, even the 3x strong hooks are surprisingly light for their size and their strength is unparalleled. These hooks will hold a point much better than stainless steel hooks and are sticky sharp right out of the bag. No sharpening is ever needed before fishing with a Gamakatsu hook and because they're not stainless, they will eventually corrode out of a fish's mouth if the hook is taken deep and cannot be removed. From the flats to blue water, there's no hook selection better than this.

- Corrosion Resistant Tin Finish
- Multiple styles to choose from
- Innovative designs



By Drew Chicone

R17-B

Retainer Bend Barbless

Multi-use. Unique Bend holds fish firm
25 pk & 100 pk: Color: MB

NANO SMOOTH COAT

22  335299-20

R18-B

Barbless 2x Strong

Multi-use. Unique Bend holds fish firm
Nano Smooth Coat
20 pk: Color:

NANO SMOOTH COAT

14  346203-20

R19-B

Retainer Bend Barbless 3x Fine

Multi-use. Unique Bend holds fish firm
Nano Smooth Coat
20 pk: Color:

NANO SMOOTH COAT

10  373205-20

12  373204-20

14  373203-20

16  373202-20

18  373201-20

This new hook utilizes a customized bend that holds fish tight and offers a revolutionary advancement in true barbless hook design. Combined with a nano smooth coating and razor sharp hook point, reduce resistance, creating more penetrating power and a seriously effective hookset.

Jig Nymph - J20

Beads and Slotted Beads
20 pk: Color: MB

10  354405-20

12  354404-20

14  354403-20

16  354402-20

Jig Nymph - J20

Barbless

Beads and Slotted Beads
20 pk: Color: MB

10  355405-20

12  355404-20

14  355403-20

16  355402-20

Trout Stinger - S25S

Multi-use, Streamers, Large Nymphs,
Bead Heads
Color: NSB

8  478206-20

10  478205-20

12  478204-20

14  478203-20

S25S Trout Stinger Hook is an incredible offering for anglers tying and presenting flies with a straight eye.

Built with durability, sharpness and presentation in mind, the S25S is ideal for various patterns, including streamers, large nymphs and bead heads to name a few. The no-shine black finish blends into most designs, drawing attention to the fly and not the hook.

S10

Standard Down Eye

Multi-use Dries and Wets
25 pk & 100 pk: Color: NSB

6  08407-25
08407-100

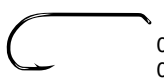
8  08406-25
08406-100

10  08405-25
08405-100

12  08404-25
08404-100

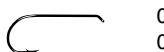
14  08403-25
08403-100

16  08402-25
08402-100

18  08401-25
08401-100

S10-B

Standard Down Eye Barbless

Multi-use Dries and Wets
25 pk & 100 pk: Color: NSB

6  41407-25
41407-100

8  41406-25
41406-100

10  41405-25
41405-100

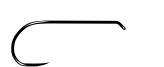
12  41404-25
41404-100

14  41403-25
41403-100

16  41402-25
41402-100

Numbering System

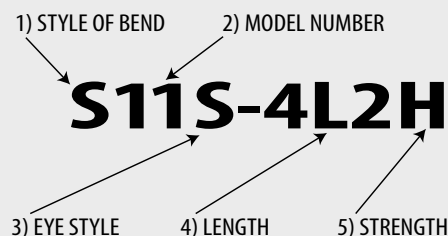

- 1) **STYLE OF BEND**
(S) Sproat (L) Limerick (P) Perfect (T) Tapered (C) Curve
(R) Retainer (B) Bend

- 2) **MODEL NUMBER**
- 3) **EYE STYLE**
(S) Straight (U) Up

- 4) **LENGTH**
(L) Long (S) Short

- 5) **STRENGTH**
(F) Fine (H) Hard/Strong

Examples:
2H = 2x Hard/Strong
1F = 1x Fine

S11S-4L2H = Sproat Bend, Model 11, Straight Eye, 4X Long and 2X Strong

B10S

Stinger, 1x Strong Forged

Hair Bugs, Streamers

25 pk & 100 pk: Color: NSB

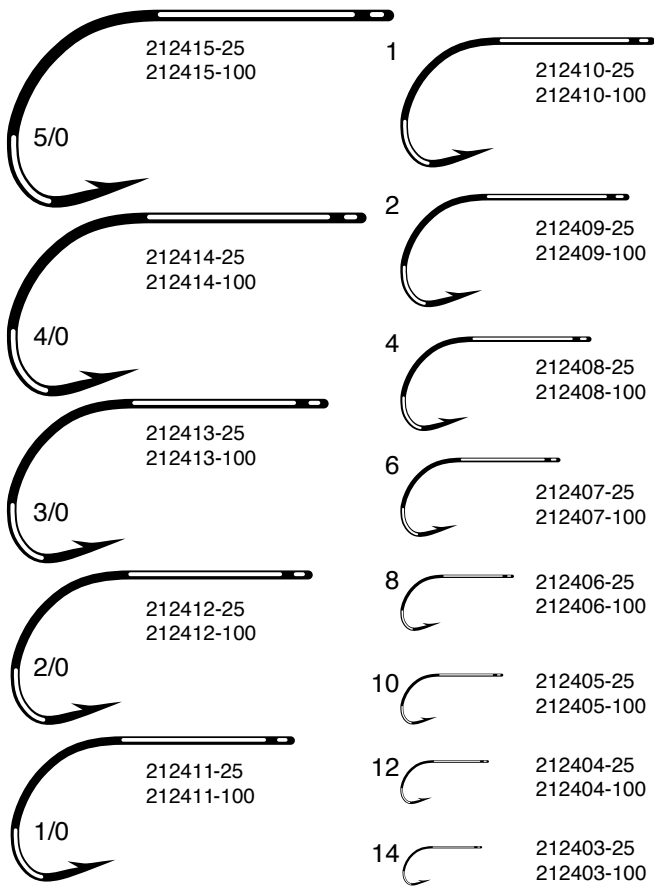

B10S Stinger

Tournament Grade Wire,

Nano Smooth Coat

Hair Bugs, Streamers • 20 pk:



Tournament Grade Wire

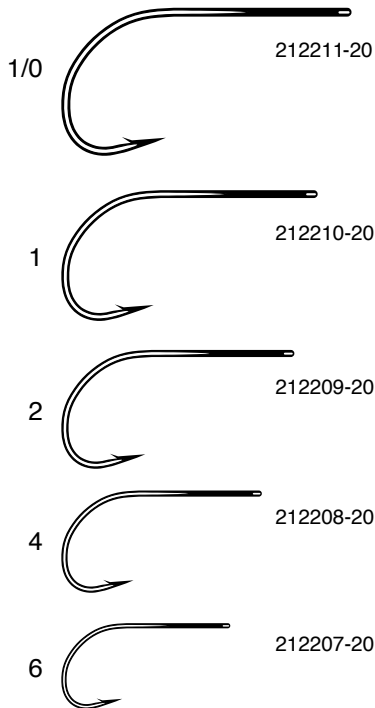

C14S

Glo Bug

Glo Bugs and other Egg Patterns

25 pk & 100 pk: Color: NSB

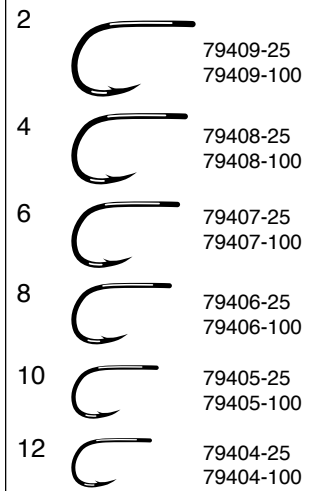

C16-B

Crippled Emerger

Emerger Patterns, Multi-use

25 pk & 100 pk: Color: NSB



SBB26 Bend Back

The Gamakatsu SBB26 Bend Back hook features a specially designed bend on the shank, allowing the fly to ride upside down in the water with the hook point in an upright or weedless position. This design helps the fly navigate cover smoothly, making it ideal for tying deceiver and baitfish patterns.

| SIZES | 4 | 2 | 1 | 1/0 | 2/0 |
|----------|-----------|-----------|-----------|-----------|-----------|
| NS Black | 464408-20 | 464409-20 | 464410-20 | 464411-20 | 464412-20 |

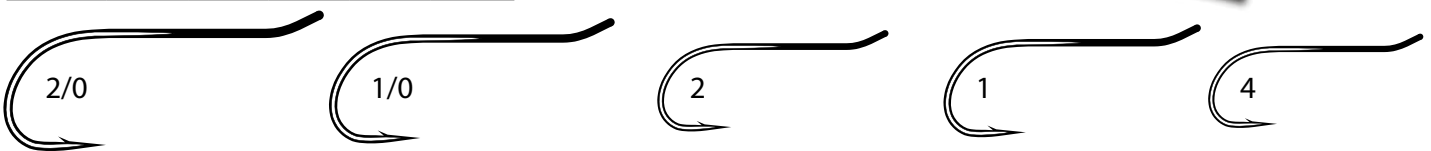

B10S Stinger • Fluorescent

Stinger, 1x Strong Forged Hair Bugs, Streamers

The B10S Stinger is one of Gamakatsu's most popular fly hooks and it just got better with the addition of fluorescent colors. The fluorescent UV coating provides a subtle glow which has been scientifically proven to attract fish and provides a focal point when they decide to eat.

The B10S Stinger is beneficial in both freshwater and saltwater fly patterns and the 1X strong wire gives you that extra confidence when a trophy fish is on the line.



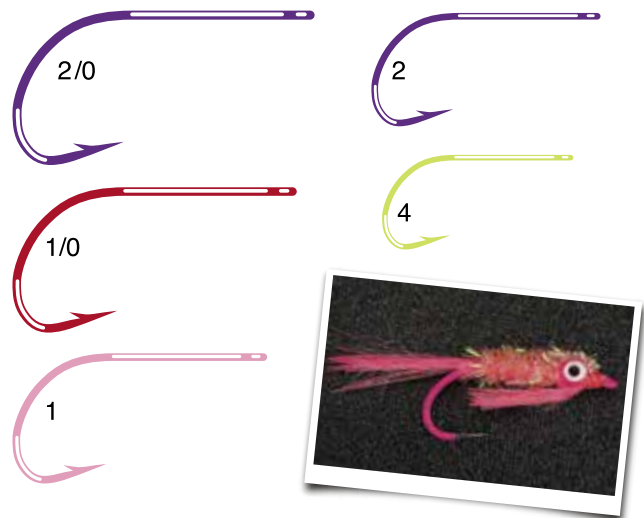



| SIZES | 4 | 2 | 1 | 1/0 | 2/0 |
|--------------|--------------|--------------|--------------|--------------|--------------|
| Ultra Violet | 212408-UV-20 | 212409-UV-20 | 212410-UV-20 | 212411-UV-20 | 212412-UV-20 |
| F-Red | 212408-FR-20 | 212409-FR-20 | 212410-FR-20 | 212411-FR-20 | 212412-FR-20 |
| F-Pink | 212408-P-20 | 212409-P-20 | 212410-P-20 | 212411-P-20 | 212412-P-20 |
| Chartreuse | 212408-C-20 | 212409-C-20 | 212410-C-20 | 212411-C-20 | 212412-C-20 |



C13U

Keel Balance

Multi-use and Keel Style dry Flies
25 pk & 100 pk: Color: MB

- 10  90405-25
90405-100
- 12  90404-25
90404-100
- 14  90403-25
90403-100
- 16  90402-25
90402-100
- 18  90401-25
90401-100
- 20  90400-25
90400-100

C15-BV

**Vertical Eye, Emerger,
Barbless**



25 pk & 100 pk: Color: NSB

- 18  267401-25
267401-100

C12-BM

Barbless Midge, Large Eye

25 pk & 100 pk: Color: NSB

- 26  277497-25
277497-100
- 28  277496-25
277496-100
- 30  277495-25
277495-100

S11-4L2H

Streamer, 4x long, 2x strong



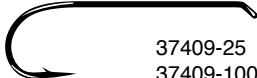
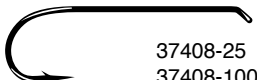
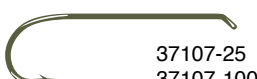
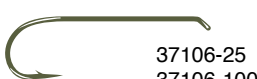

Streamers and Large Wet Flies
25 pk & 100 pk: Color: BR, NSB

- 2  37409-25
37409-100
- 4  37408-25
37408-100
- 6  37107-25
37107-100
- 8  37106-25
37106-100

C12

Down Eye Scud

Scud and Shrimp Patterns
25 pk & 100 pk: Color: BR

- 10  87105-25
87105-100
- 12  87104-25
87104-100
- 14  87103-25
87103-100
- 16  87102-25
87102-100

S11S-4L2H

Straight Eye Streamer,



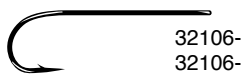
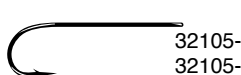

4x long, 2x strong
Woolly Buggers, Streamers and Large
Wet Flies
25 pk & 100 pk: Color: BR

- 6  32107-25
32107-100
- 8  32106-25
32106-100
- 10  32105-25
32105-100

C12U

Caddis



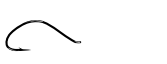

Caddis and other Pupae Patterns
25 pk & 100 pk: Color: BR

- 6  34107-25
34107-100
- 8  34106-25
34106-100
- 10  34105-25
34105-100
- 12  34104-25
34104-100
- 14  34103-25
34103-100
- 16  34102-25
34102-100

L11S-3H

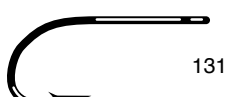
Salmon & Steelhead 3x strong



Heavy Salmon/Steelhead Flies
and tube fly trailer
20 pk: Color: NSB

- 2  13109-20
- 4  13108-20
- 6  13107-20
- 8  13106-20
- 10  13105-20

C12-B

Down Eye Scud

Barbless, Red
Scud and Shrimp patterns
25 pk & 100 pk: Color: RD

- 14  268303-25
268303-100
- 16  268302-25
268302-100
- 20  268300-25
268300-100

T10-3H

Salmon Dry 1x Fine
Salmon/Steelhead Dry Flies
20 pk: Color: NSB

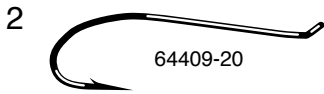

T10-6H

Salmon Tapered Loop Up-eye
Salmon/Steelhead Wet Flies

10 pk: Color: NSB, RD
Sizes: 1/0, 2/0

20 pk: Colors: NSB, RD
Sizes: 8 - 1

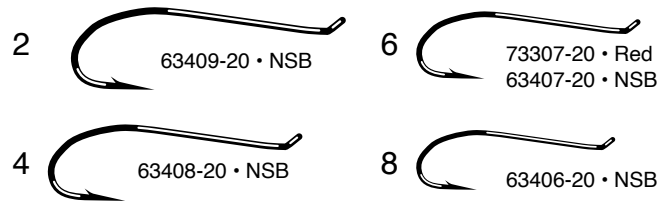

Russian River Fly

Streamers
Meets Russian River Regulations
25 pk, 100 pk: Color: BR, RD



Double 22 Medium Shank

Medium shank length designed with a straight eye manufactured in durable Nickel Silver Black.

| | | |
|----------|----|------------|
| SIZES | | 10 |
| NS Black | LS | 302405(12) |



FLY HOOKS - SALTWATER SERIES

SL12-S 1X Short

Big Game • Wide Gap
Tarpon and Billfish Flies • Loose pk,

100 pk: Color: NSB

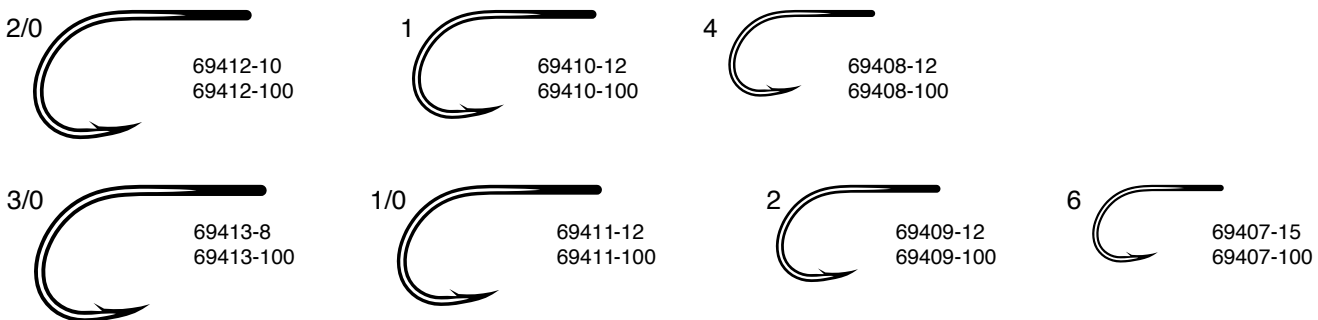

J60 Crab Pattern

The J60 Crab pattern hook was designed with a 60-degree eye, wide gap for better hookups, and straight hook point for quick penetration. Those features makes this the ideal hook for fly patterns that require the hook point to ride in the up position. Essentially making it the best choice for crab or shrimp patterns and perfect for redfish fly patterns.

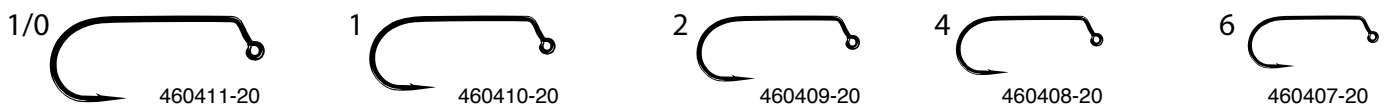

SL12S

Big Game • Wide Gap

Tarpon and Billfish Flies

Loose: Color: TN Sizes: 2, 1/0, 2/0, 4/0, 6/0, 8/0, 10/0

50 pk: Color: TN Sizes: 8/0, 10/0

100 pk: Color: TN Sizes: 2, 1/0, 2/0, 4/0, 6/0

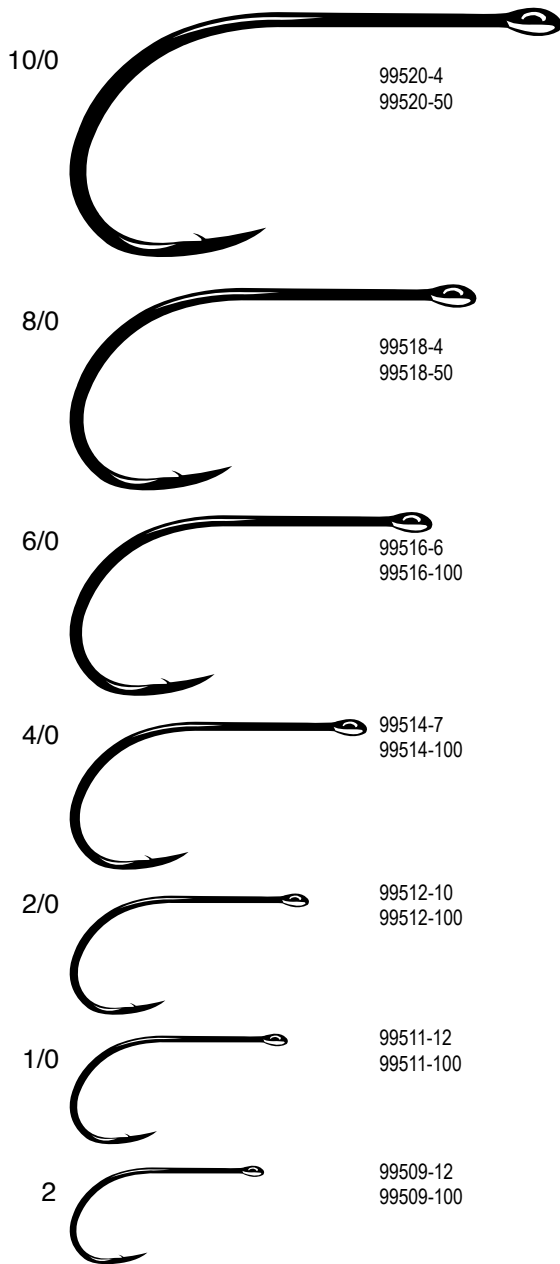

SL45

Bonefish

Small Bonefish Flies

Loose: Color: MB Sizes: 10-4

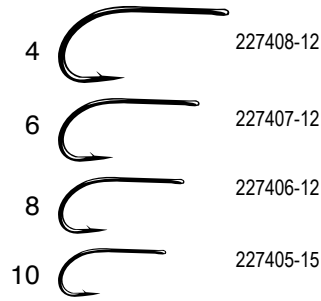

SC15-2H

Wide Gap • 2x Strong

Tarpon and Billfish Flies

Loose: Color: TN Sizes: 3/0 - 5/0

100 pk: Color: TN Sizes: 3/0 - 5/0

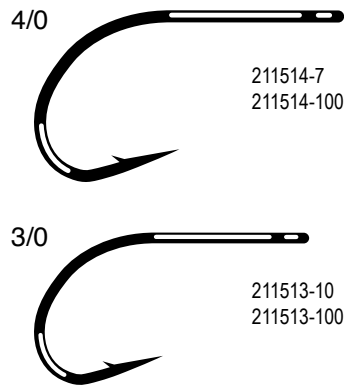

SL11-3H

3x strong

Standard Bonefish/Tarpon Flies and Billfish Flies

Loose: Color: TN Sizes: 8 - 4/0

100 pk: Color: TN Sizes: 8 - 4/0

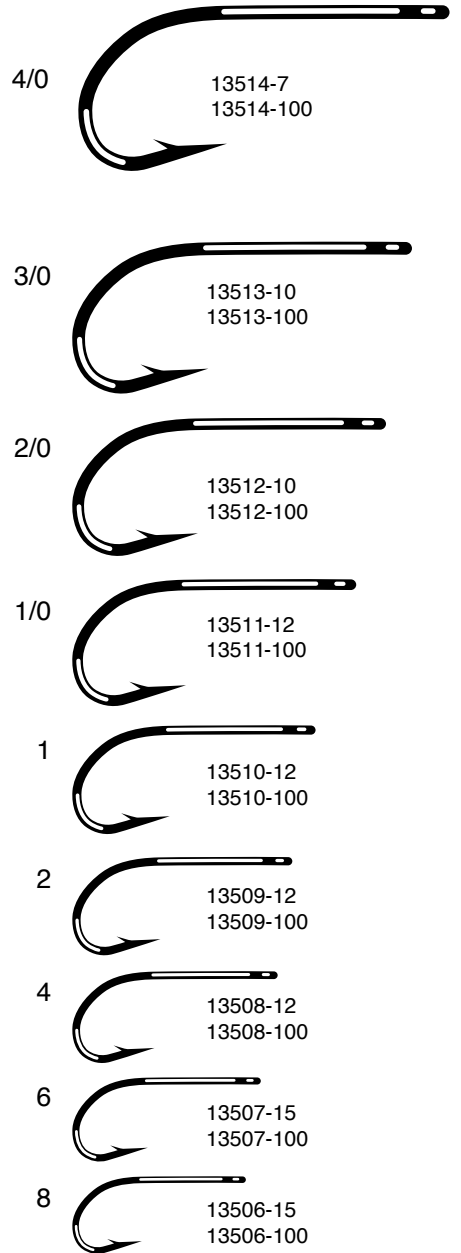

SS15

Standard

Standard Inshore Flies and

Surface Patterns

Loose: Color: TN Sizes: 10 - 2/0

100 pk: Color: TN Sizes: 10 - 2/0

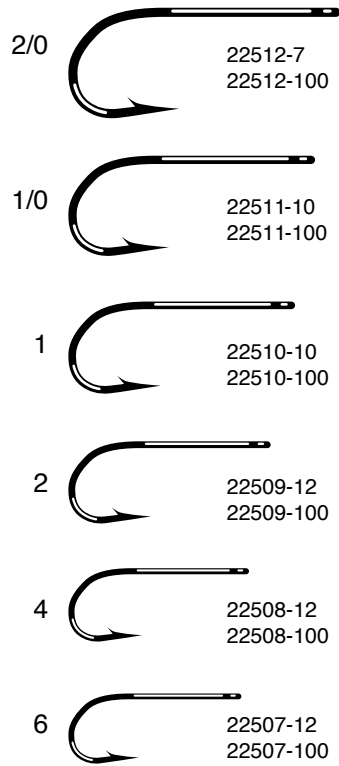

SP11-3L3H

Perfect Bend

Longer Saltwater Streamers, Poppers and Billfish Flies

Loose: Color: TN Sizes: 8 - 3/0

100 pk: Color: TN Sizes: 8 - 3/0

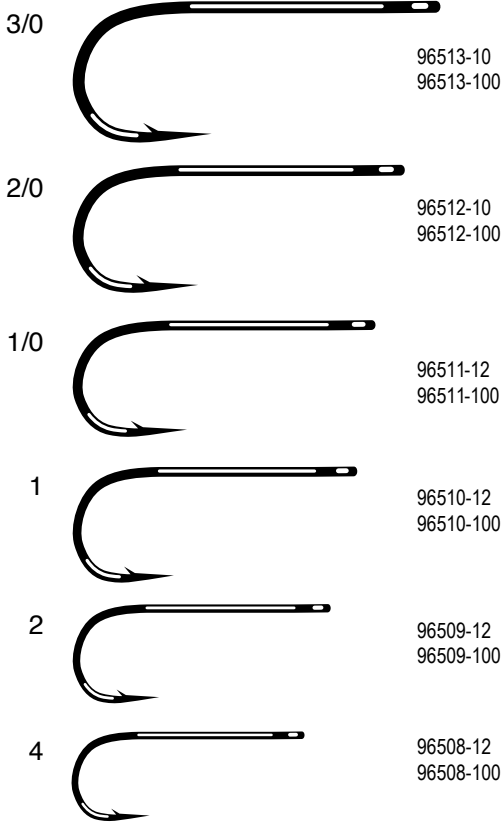

SC15

Wide Gap

Shrimp, Small Tarpon Flies,

Tube Fly Trailer

Loose: Color: TN Sizes: 8 - 3/0

100 pk: Color: TN Sizes: 8 - 3/0

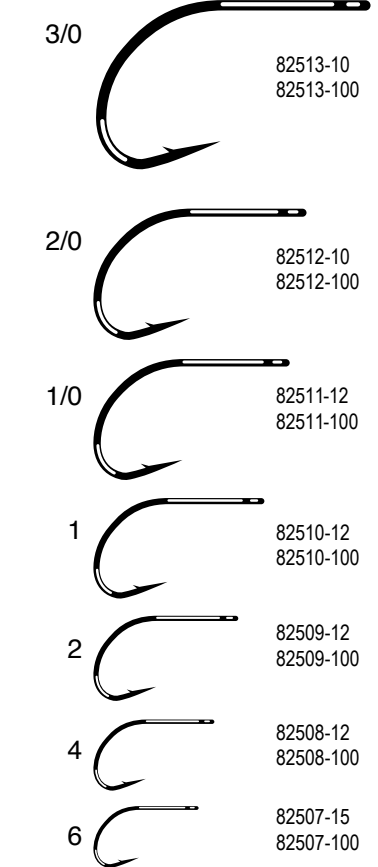









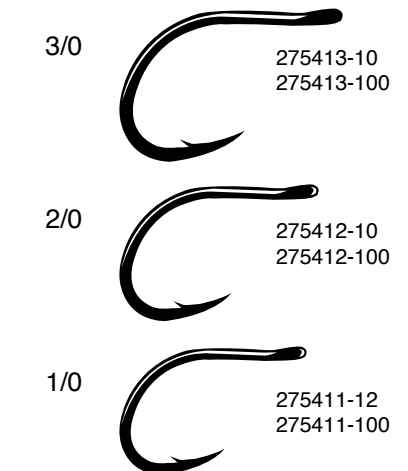



























SC17

Tarpon Fly

Tarpon Flies

Loose pk & 100 pk: Color: NB



| DESCRIPTION | GAMAKATSU Model # | MUSTAD | TIEMCO | DAIICHI | DAI-RIKI |
|--|-------------------|--------|--------|---------|----------|
|  Standard Down Eye | S10 | 94840 | 5210 | 1170 | 300 |
|  Standard Down Eye Barbless | S10B | 94845 | 900BL | 1190 | |
|  Straight Eye Dry | S10S | 94859 | 101 | 1110 | 310 |
|  Retainer Bend Barbless | R10-B | | | | |
|  Retainer Bend Barbless 3X Fine | R17B | | | | |
|  Retainer Bend Barbless 2X Strong | R18B | | | | |
|  Retainer Bend Barbless | R19-B | | | | |
|  Stinger 1x Strong Forged | B10S | 37187 | | 2720 | |
|  TGW / Nano Smooth | B10S | | | | |
|  Stinger Fluorescent | B10S | | | | |
|  Glo Bug | C14S | 9479 | 105 | 1510 | |
|  Keel Balance | C13U | | | | |
|  Vertical Eye Emerger Barbless | C15-BV | | | | |
|  Emerger Patterns Multi Use | C16-B | | | | |
|  Barbless Midge Large Eye | C12-BM | | | | |
|  Jig Nymph Barbed | J-20 | | | | |
|  Jig Nymph Barbless | J-20 | | C403BL | | |
|  Salmon Steelhead 3x Strong | L11S-3H | 3406 | 800 | 2451 | |
|  Streamer 4x Long 2x Strong | S11-4L2H | 79580 | 9395 | 2220 | 700 |
|  Streamer 4x Long 2x Strong SE | S11S-4L2H | 9674 | 9395 | 2220 | |
|  Scud | C12 | 80250 | 2487 | 1130 | |
|  Caddis | C12U | 37160 | 205BL | 1140 | |
|  Scud, Barbless | C12-B | | 2487BL | | |
|  Salmon Steelhead Dry 1x Fine | T10-3H | 90240 | 7989 | 2421 | |
|  Salmon Steelhead Wet | T10-6H | 36890 | 7999 | 2161 | 899 |
|  Russian River Fly | Russian River | 36717 | | | |
|  Double Hook Medium Shank | Double 22 | | | | |
|  Saltwater Big Game | SL12S | | | | |
|  Bonefish | SL45 | | | | |
|  Saltwater 3x Strong | SL11-3H | | | | |
|  Standard Saltwater | SS15 | 34007 | 8115 | 2546 | 930 |
|  Saltwater Perfect Bend | SP11-3L3H | | | | |
|  Saltwater Wide Gap | SC15 | | | | |
|  Saltwater Wide Gap 2x Strong | SC15-2H | | | | |
|  Tarpon Fly | SC17 | | | | |
|  Saltwater | SL12-S 1X Short | | | | |





TERMINAL

Spinnaker[®]

Spring Lock

The new Gamakatsu Spring Lock makes rigging plastics easy with the stress relieved stainless steel center point. The center point makes it easy to find the exact midpoint of the bait. It's then just a simple matter of twisting the plastic on to the Spring Lock where it stays fastened and secure. Lures stay centered and run straight and true.

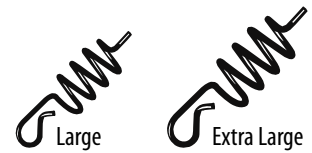

| SIZES | Large | Extra Large |
|-----------------|-------------|--------------|
| Stainless Steel | 397000-L(5) | 397000-XL(5) |

Double Down Spring Lock

The Double Down Spring Lock features not one but two retaining wires wound in parallel, so soft plastics stay rigged as intended. Add the simple-to-rig double wire rig to a favorite Gamakatsu hook and holding power is maximized. Simply twist on your favorite soft plastic bait and know that it will stay locked on allowing it to run straight and true cast after cast.

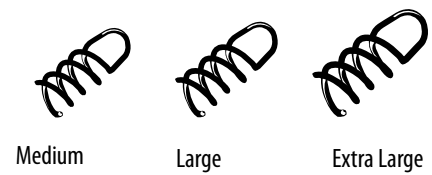

| SIZES | Medium | Large | Extra Large |
|-----------------|-------------|-------------|--------------|
| Stainless Steel | 431000-M(8) | 431000-L(8) | 431000-XL(8) |



Silicone Stopper

The premium quality Silicone Stopper aids in keeping a trailer hook from getting tangled in the skirt when fishing spinnerbaits and buzzbaits. It prevents the hook from sliding up and down the hook shank, and ensures that when bass bite, they get hooked. Although designed for spinnerbaits and buzzbaits, the Silicone Stopper can be used with Texas-rigged worms, too. The only limit to their application is your imagination.



| SIZES | Medium | Large | Extra Large | X Extra Large |
|-------|--------------|--------------|---------------|----------------|
| Black | 393000-M(12) | 393000-L(12) | 393000-XL(10) | 393000-XXL(10) |



Superline Swivel

The Superline Swivel is manufactured from premium components offering a superior strength to size ratio and an NS Black (nickel silver black) coating is applied for a stealthy finish that resists corrosion. Swivels are available in sizes 10 to 1, with break strengths of 35 to 330 pounds. Whether you chase Bluegill or Bigeye, Gamakatsu has a swivel for you.

| SIZES | 10 (35 lb) | 8 (50 lb) | 7 (75 lb) | 6 (80 lb) | 5 (120 lb) | 4 (130 lb) | 2 (230 lb) | 1 (330 lb) |
|----------|---------------|-------------|-------------|-------------|-------------|-------------|-------------|-------------|
| NS Black | 405400-10(10) | 405400-8(8) | 405400-7(8) | 405400-6(8) | 405400-5(8) | 405400-4(8) | 405400-2(6) | 405400-1(5) |

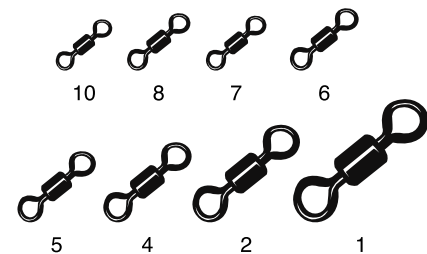

Duo Lock Snap with Superline Swivel

Freshwater anglers, and those employing light tackle out in saltwater will gravitate toward the lightweight Duo Lock Snap with Superline Swivel, rated from 35- to 120-pound test, in sizes from 12 to 5. Featuring an NS Black (nickel silver black) coating that provides stealth and corrosion resistance with strength beyond its size.

| SIZES | 12 (35 lb) | 10 (35 lb) | 8 (50 lb) | 7 (75 lb) | 5 (120 lb) |
|----------|--------------|--------------|-------------|-------------|-------------|
| NS Black | 406400-12(5) | 406400-10(5) | 406400-8(5) | 406400-7(5) | 406400-5(5) |

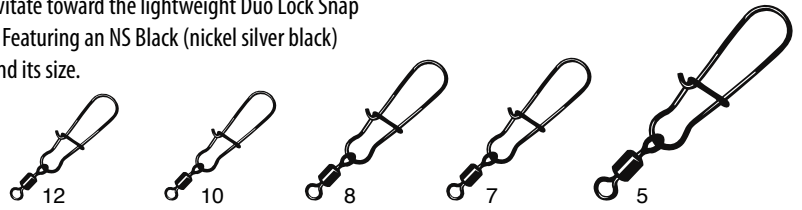

Cross Lock Snap with Superline Swivel

The Cross Lock Snap with Superline Swivel was designed for anglers chasing larger quarry and is offered in sizes 7 through 2 rated from 75 to 230 pounds. This heavy-duty version offers superior strength to size ratio and features an NS Black (nickel silver black) coating providing a stealthy presentation.

| SIZES | 7(75 lb) | 6(80 lb) | 4(130 lb) | 2(230 lb) |
|----------|-------------|-------------|-------------|-------------|
| NS Black | 407400-7(4) | 407400-6(4) | 407400-4(4) | 407400-2(4) |

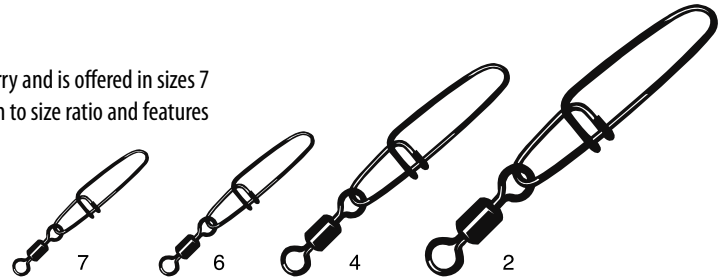

Superline Split Ring

The new Superline Split Ring is available in sizes to outfit everything from panfish spinners to baits intended for hard-chargers such as roosterfish. The Japanese-made split ring is constructed of high strength stainless steel giving you confidence that it can handle that trophy catch. All of the edges are rounded, preventing wear on your line during the most intense battle.

| SIZES | 1 (10 lb) | 2 (18 lb) | 3 (44 lb) | 4 (48 lb) | 5 (97 lb) | 6 (130 lb) | 7 (180 lb) | 8 (255 lb) |
|-----------------|--------------|--------------|--------------|--------------|-------------|-------------|-------------|-------------|
| Stainless Steel | 408000-1(12) | 408000-2(12) | 408000-3(12) | 408000-4(10) | 408000-5(9) | 408000-6(8) | 408000-7(7) | 408000-8(5) |

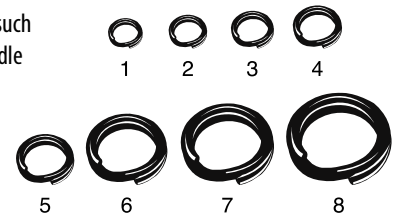

Superline Solid Ring

Gamakatsu's new Superline Solid Ring is the perfect complement to their line of assist hooks, providing a solid connection that even the most headstrong tuna can't bust. The solid ring is completely rounded to keep your line in good shape as the battle enters extra innings. When you need to apply extra pressure on that fish of a lifetime, the welded high strength stainless steel construction won't let you down.

| SIZES | 4 (200 lb) | 5 (350 lb) | 6 (400 lb) | 7 (700 lb) |
|-----------------|--------------|-------------|-------------|-------------|
| Stainless Steel | 409000-4(10) | 409000-5(8) | 409000-6(7) | 409000-7(6) |

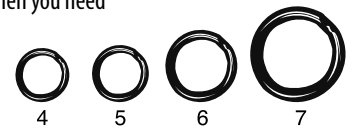

One Touch Blade

Add instant flash and vibration to any lure with the One Touch Blade. Featuring both Nickel and Gold-finished Willow Leaf (#2) and Colorado (#1) blades, this easy-to-use trailer instantly upgrades spinnerbaits, buzz baits, and more. The integrated glow cap makes attachment quick—attach it to your lure to boost visibility and action. For even more versatility, remove the glow cap and use the high-quality snap swivel to connect directly to a lure’s eye.

- Dual-blade setup: Willow (#2) & Colorado (#1)
- Nickel and Gold finishes
- Glow cap attachment or snap swivel option
- Instantly adds flash and attraction to any lure

| SIZES | One Size |
|-----------------|---------------|
| Colorado Gold | 19387-M-EN(2) |
| Colorado Nickel | 19388-M-EN(2) |
| Willow Gold | 19389-L-EN(2) |
| Willow Nickel | 19390-L-EN(2) |



One Touch Blade (for Treble Hooks)

Give your crankbaits and plugs a serious visual upgrade with the One Touch Blade for Treble Hooks. Designed to attach directly to a treble hook, this system uses a unique bead-locking mechanism to stay secure and in-line during retrieves. Available in Small, Medium, and Large, each size comes in two different blade styles: a Gold/Nickel Willow Leaf (#1.5 or #2) or a Colorado (#1) blade. Whether you’re after finesse or full flash, this attachment brings life to any hard bait.

- Sizes: Small (fits #10–8 treble), Medium (#8–6), Large (#6–4)
- Willow Blade Sizes: Small & Medium #1.5, Large #2
- Colorado Blade Size: #1 (all sizes)
- Attaches directly to treble hook with innovative bead-lock system
- Includes replacement beads

| SIZES | S | M | L |
|-----------------|---------------|---------------|---------------|
| Colorado Gold | 19383-S-EN(2) | 19383-M-EN(2) | 19383-L-EN(2) |
| Colorado Nickel | 19384-S-EN(2) | 19384-M-EN(2) | 19384-L-EN(2) |
| Willow Gold | 19385-S-EN(2) | 19385-M-EN(2) | 19385-L-EN(2) |
| Willow Nickel | 19386-S-EN(2) | 19386-M-EN(2) | 19386-L-EN(2) |

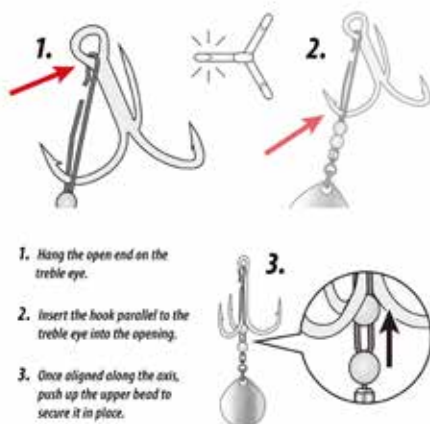



TACKLE STORAGE

Spinnaker[®]

G-Box Tuning and Terminal Utility Case

Built for maximum efficiency on the water, the G-Box Tuning & Terminal Utility Case delivers smart, customizable storage for hooks, split rings, and tuning essentials. Featuring adjustable dividers that let anglers fine-tune each compartment, it keeps terminal tackle organized, visible, and ready for quick changes. Designed with the durability and secure closure the G-Box system is known for, it helps eliminate clutter and wasted space so you can stay focused and fish more efficiently.

- Size 10" x 7.5" x 1"
 - Ideal for hooks, split rings, and tuning components
 - Adjustable dividers for customized storage
 - Keeps small terminal tackle organized and visible
 - Durable construction with secure closure
 - Efficient layout for quick access on the water
- Item #G3600TT

NEW



G-Box Quatro Joint Loc Case 250

The Quatro Joint Loc Case 250 features a Joint Loc system that securely connects two boxes into one cohesive unit for streamlined storage. A micro rib adjustable divider system keeps terminal tackle separated and secure, making it perfect for day use, backpacking anglers, or fishermen on the go.

- Size 6.9" x 4.1" x 0.7"
 - Four-panel design for maximum organization
 - Independent sections for easy access
 - Slide-to-lock system for secure closure
 - Ideal for small terminal tackle and components
 - Durable construction for long-lasting use
- Item #G250QT

NEW



G-Box Adjustable Lure Case 3200

Built for anglers who want clean, tangle-free storage, the G-Box Adjustable Lure Case 3200 features a smart layout designed to secure rigged lures and terminal setups in place. The customizable divider system lets you fine-tune compartments to fit a variety of lure sizes, while the durable construction and secure latch keep contents protected in transit. With dedicated channels that help keep hooks separated and organized, it's an efficient, no-nonsense solution for keeping your go-to rigs ready and easy to access on the water.

- Size 8.1" x 5.7" x 0.9"
 - Designed for rigged lures and terminal setups
 - Adjustable dividers for customized storage
 - Hook-separating channels reduce tangles
 - Secure latch keeps contents protected
 - Slim profile fits easily in tackle storage
- Item #G3200SS

NEW



G-Box 3200, Utility Case

- Size 8.1" x 5.7" x 1.6".
- Great for terminal tackle and small lures.
- Micro Rib System- Micro Adjustable Dividers.
- Easily opened with one hand.
- Does not open when dropped.
- Tackle stays in place and does not go to other compartments.
- Rounded corners easy to get out of tackle bags or boat compartments.

Item #G3200

Micro Rib System - Micro Adjustable Dividers

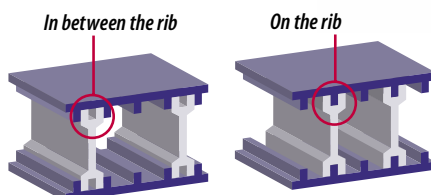

G-Box 3200D Deep Utility Case

The G-Box 3200D Deep Utility Case features the single-hand, easy-open lid clasp and offers adjustable storage with micro-slit compartmental dividers. This feature allows the angler to adjust each bin size to fit specific gear. Tight tolerances ensure that small terminal tackle doesn't jump from one compartment to the other. The 3200D is made in Japan and is an excellent storage solution for both terminal tackle and lures.

- Size 8.1" x 5.7" X 2.4"
- Great for terminal tackle and small lures.
- Micro Rib System- Micro Adjustable Dividers.
- Easily opened with one hand.
- Does not open when dropped.
- Tackle stays in place and does not go to other compartments.
- Rounded corners easy to get out of tackle bags or boat compartments.

Item #G3200D



G-Box Reversible 3200 Utility Case

Gamakatsu takes tackle storage to the next level with the new G-Box 3200 Reversible Utility Case. The innovative design places a lid on both sides of the box, effectively creating two separate containers in one unit. Each side of the G-Box 3200 Reversible Utility Case has its own lid, doubling tangle-free storage space in each container. The new design features V-shaped dividers that keep saltwater jigs, crankbaits and other favorites organized and ready to go. Stash a different type of lure on each side and switch fishing styles with a flip of a box. Wide, locking latches keep the boxes securely shut even if they bounce along in the boat or your bag.

- Size 8.1" x 5.7" X 2"
- Opens on both sides of the box
- Easily opened with one hand.
- Does not open when dropped.
- Rounded corners easy to get out of tackle bags or boat compartments.

Item #G3200RV



G-Box 3500D Deep Utility Case

The G-Box 3500 is nearly 2.4" deep, so big-lipped and fat-bodied, baits fit with ease. It's 7.4" wide to accommodate stick baits, long spinners and spinner blades. The clear top lets you see what's inside and the one-handed, easy-opening design makes access exceptionally convenient. Of course, the dividers are fully adjustable too

- Size 10" x 7.4" x 2.4".
- Great for plastic baits and hardbaits.
- Micro Rib System- Micro Adjustable Dividers.
- Easily opened with one hand.
- Does not open when dropped.
- Adjustable Layout Vertically and Horizontally.
- Tackle stays in place and does not go to other compartments.
- Rounded corners easy to get out of tackle bags or boat compartments.

Item #G3500D

**G-Box 3600, Utility Case**

- Size 10.8" x 7.4" x 1.7".
- Great for plastic baits and hardbaits.
- Micro Rib System- Micro Adjustable Dividers.
- Easily opened with one hand.
- Does not open when dropped.
- Adjustable Layout Vertically and Horizontally.
- Tackle stays in place and does not go to other compartments.
- Rounded corners easy to get out of tackle bags or boat compartments.

Item #G3600

**G-Box Reversible 3600 Utility Case**

Gamakatsu takes tackle storage to the next level with the new G-Box 3600 Reversible Utility Case. The innovative design places a lid on both sides of the box, effectively creating two separate containers in one unit. Each side of the G-Box 3600 Reversible Utility Case has its own lid, doubling tangle-free storage space in each container. The new design features V-shaped dividers that keep saltwater jigs, crankbaits and other favorites organized and ready to go. Stash a different type of lure on each side and switch fishing styles with a flip of a box. Wide, locking latches keep the boxes securely shut even if they bounce along in the boat or your bag.

- Size 10" x 7.5" x 2.4"
- Opens on both sides of the box
- Easily opened with one hand.
- Does not open when dropped.
- Rounded corners easy to get out of tackle bags or boat compartments.

Item #G3600RV



G-Box 3700, Utility Case

- Size 14" x 9" x 2".
- Great for terminal tackle and small lures.
- Micro Rib System- Micro Adjustable Dividers.
- Easily opened with one hand.
- Does not open when dropped.
- Tackle stays in place and does not go to other compartments.
- Rounded corners easy to get out of tackle bags or boat compartments.

Item #G3700

**G-Box 3700D Deep Utility Case**

The G-Box 3700D Deep Utility Case is perfect for those larger bulky lures and features the single-hand, easy-open lid clasp. Adjustable storage with micro-slit compartmental dividers allows the angler to adjust each bin size to fit specific gear. Tight tolerances ensure that small terminal tackle doesn't jump from one compartment to the other. The 3700D is made in Japan and is an excellent storage solution for a variety of larger tackle.

- 14" x 9" x 3.2"
- Great for terminal tackle and small lures.
- Micro Rib System- Micro Adjustable Dividers.
- Easily opened with one hand.
- Does not open when dropped.
- Tackle stays in place and does not go to other compartments.
- Rounded corners easy to get out of tackle bags or boat compartments.

Item #G3700D

**G-Box 3700D2 Deep Utility Case**

The G-Box 3700D2 Deep Utility Case features an open box layout with no dividers so anglers can easily stash bulky items like pliers, de-hooking tools, or bulk soft plastics. The hard shell keeps items protected, while the single-hand, easy-open lid clasp allows for easy access. In addition, the lid's tight tolerances ensure even small items can't work their way out when the boat encounters some chop or the road turns rough.

- 14" x 9" x 3.2"
- Great for large bulky items.
- Easily opened with one hand.
- Does not open when dropped.
- Rounded corners easy to get out of tackle bags or boat compartments.

Item #G3700D2



G-Box 250, Duo Side Slit Foam Utility Case

- Size 7" x 4.2" x 1.6"
- Great for Rigs, Hooks, Flies and Jig Heads.
- Easy to See Slit Foam on one side.
- Micro Rib System- Micro Adjustable Dividers on other side.
- Easily opened with one hand.
- Product stays in place and organized.
- Rounded corners easy to get out of tackle bags or boat compartments.

Item #G250DS

**G-Box 3200, Slit Foam Utility Case**

- Size 8.1" x 5.7" x 1.6"
- Great for Rigs, Hooks, Flies and Jig Heads.
- Easy to See Slits.
- Easily opened with one hand.
- Product stays in place and organized.
- Rounded corners easy to get out of tackle bags or boat compartments.

Item #G3200SF

**G-Box 3600, Slit Foam Utility Case**

- Size 10" x 7.5" x 1.1"
- Great for Rigs, Hooks, Flies and Jig Heads.
- Easy to See Slits.
- Easily opened with one hand.
- Product stays in place and organized.
- Rounded corners easy to get out of tackle bags or boat compartments.

Item #G3600SF

**G-Box 3200 and 3600 Double Sided Slit Foam Utility Case**

Say goodbye to tangled tackle and hello to streamlined storage with the Gamakatsu G-Box Double Slit Foam Utility Case. Designed with double-sided precision-cut slit foam, this compact utility box securely holds hooks, jigs, flies, all while maximizing storage space.

The clever layout makes organizing small tackle effortless, keeping everything right where you need it and tangle-free. Built for convenience, the case features a one-handed opening design for quick access and rounded corners that make it easy to retrieve from a packed tackle bag or boat compartment.

G-Box 3200 (8.1" x 5.7" x 1.6") • Item #G3200SFD

G-Box 3600 (10.8" x 7.4" x 1.7") • Item #G3600SFD



G-Box 318SD Pocket Utility Case

The G-Box 318SD Pocket Utility Case is made for anglers on the move. The 318SD is designed for adventurous anglers who walk the shorelines of lakes and rivers in search of secret spots and untouched fish. The G318SD features adjustable dividers one side allowing anglers to customize their terminal tackle storage. Carry the essentials and always have critical terminal tackle and spare lures at your fingertips without hauling a heavy pack.

- Size 4.8 x 3.4 x 1.3
- Great for Hooks, Flies and Jig Heads.
- Easily opened with one hand.
- Product stays in place and organized.
- Rounded corners easy to get out of tackle bags or boat compartments.

Item #G318SD



G-Box 388DD Pocket Utility Case

The G-Box 388DD Pocket Utility Case is made for anglers on the move. The 388DD is designed for adventurous anglers who walk the shorelines of lakes and rivers in search of secret spots and untouched fish. The G388DD compartments are not adjustable but have multiple compartments that are designed to carry a wide variety of terminal tackle. Carry the essentials and always have critical terminal tackle and spare lures at your fingertips without hauling a heavy pack.

- Size 4.8" x 3.8" x 1.3"
- Great for Hooks, Flies and Jig Heads.
- Easily opened with one hand.
- Product stays in place and organized.
- Rounded corners easy to get out of tackle bags or boat compartments.

Item #G388DD



G-Case 3000

Gamakatsu®, the world's leading manufacturer and innovator of fishing hooks and terminal tackle introduces the newest addition to the G-Box series, the G-Case 3000. The G-Case 3000 solves all your tackle solutions in a premium way. Equally effective in freshwater or saltwater, the G-Case 3000 is manufactured in Japan from strong and durable plastic for years of reliable use. The box starts with a large and comfortable handle that has a locking feature when in the upright position to keep the contents secure. The handle allows for easy transport in the boat or on the shore. The hinged lid flips back to create a surface work area table that can be used for lure rigging. Storage abounds in this unique box with two different customizable storage compartments. Opening the olive-colored lid reveals a quick grab section that has six removeable dividers that an angler can customize to their own preferences. The main inside storage area has two customizable, removeable dividers that allow a user to easily create custom configurations to meet their personal needs. The overall dimensions of the box are 17.1" x 9.2" x 10.7." Item #GC3000



G-Case 7000

The G-Case 7000 is an ultra-durable, hard-sided tackle storage case that is compatible with G-Boxes in all sizes, creating a flexible system that has endless storage configuration possibilities. The G-Case 7000 utilizes a strong, sturdy handle and the lid can be opened from either side, allowing for quick access. The interior has an open tray for loose items like line spools and tools. Add the optional rod stand, jig compartment, and shoulder strap to transform the G-Case 7000 into a real-time fishing asset.

- Size 19" x 13" x 13"

Item #G7000

**G-Case 7000 Jig Compartment**

Anglers are always changing lures and cycling through gear, and the optional exterior side mounted jig compartment attaches securely to the G-Case 7000 and offers an open, top-slotted compartment for quick access to your go-to lures. Store and dry them after use as well before moving lures back into permanent G-Box utility cases. This exterior storage option is a time saver when quick changes are needed in the field.

- Size 10 x 5.7 x 2.2

Item #G7000-JC

**G-Case 7000 Rod Stand**

The G-Case 7000 has three different positions on either side to attach the optional rod stand. A simple mounting bracket makes a firm connection, transforming the case into a rod holder with a permanent locking mechanism. The rod stand offers rod height adjustments to hold a variety of rod types. In addition, the rod stand features an adjustable foot, making it a sturdy base for the G-Case.

- Size 2.6 x 2.8 x 13

Item #G7000-RS

**G-Case 7000 Shoulder Strap**

If you need to free up your hands while trying to carry all your gear simply add the optional shoulder strap to make carrying the G-Case 7000 a breeze.

- Size 1.5" x 79"

Item #G7000-SS



G-Bag EWM 5000 H Tackle Bag

The G-Bag EWM 5000 H Tackle Bag features an Extra Wide Mouth (EWM) opening for easy access. An internal wire frame keeps the main compartment in the open position allowing anglers to sort through their tackle and find that perfect bait with ease. Anglers can fit up to five Gamakatsu G-Box 3700 or eight 3600 utility cases inside. A quick-access magnetic front pocket flap also stays in an open position, letting anglers effortlessly grab often needed items from the handy pocket. The durable, 1680 denier polyester construction stands up to a rough life on the water, with a water- and slip-resistant EVA molded base that protects the contents against moisture.

16" x 11" x 13.25" • Item #GB-EWM-5000H



G-Bag EWM 300 Tackle Bag

The G-Bag EWM 300 is the largest size in the lineup and is designed to carry a variety of tackle comfortably, thanks to the adjustable, padded removable shoulder strap. The generous 13 x 8.5 x 11-inch bag lets anglers stockpile all of their finesse baits and power fishing lures in the same place so they can be prepared for anything. Stuff up to four Gamakatsu G-Box 3600 or eight 3200 utility cases into the G-Bag EWM 300 using the innovative Extra Wide Mouth opening. 13 x 8.5 x 11 • Item #GB-EWM-300



Durable 600D water resistant polyester with PVC backing.



G-Bag EWM 200 Tackle Bag

The G-Bag EWM 200 Tackle Bag stows more gear using the same innovative easy-access stay-open top. The 9.5 x 5 x 7-inch size easily accommodates magnum packs of soft plastics and oversized bulk bags, so that anglers can stash their largest swimbaits or enough tubes for the season in one convenient location. In addition, there's enough space to store a wide variety of tackle and gear, so anglers can keep rigging tools and other essentials handy as well. 9.5 x 5 x 7 • Item #GB-EWM-200



Durable 600D water resistant polyester with PVC backing.

**G-Bag EWM 100 Tackle Bag**

The G-Bag EWM 100, is the perfect size for holding a variety of soft plastic packs. The Extra Wide Mouth (EWM) provides easy access to the interior, and the internal wire frame keeps the top open while finding the right bait. The 8 x 4 x 6-inch size stows easily in other bags, and anglers can take as many as needed while remaining organized. Pick up a few and keep all smaller items organized and ready.

8 x 4 x 6 • Item #GB-EWM-100



Durable 600D water resistant polyester with PVC backing.



Shoulder Bag Tackle Storage

The perfect mobile storage solution when you're on the go and need fast, easy access to your gear. Designed for over-the-shoulder carrying: Swing bag to your chest for access, swing around to your back when walking, casting or battling fish. Includes two (2) G3200 G-Boxes in the main compartment and features multiple, heavy-duty zippered pockets to store everything else. The 1680 denier ballistic nylon is tough so it will hold up for years of use and the padded shoulder strap is adjustable for length.

Item #BAG006



Backpack Tackle Storage

When you need to carry enough tackle for wherever your angling adventure may lead you, strap on our Backpack Tackle Storage solution. Made from 1680 Denier Ballistic Nylon, it's tough, light and easy to carry. The interior pouch can be adjusted from one large compartment to two smaller ones. Exterior carry pockets on both sides are designed to hold fishing rods or water bottles. Includes two (2) G3600 and one (1) G3500D G-Boxes.

- Dimensions: 17" x 12" x 8".
- Backpack design with adjustable waist strap.
- Comfortable 3d mesh padding.

Item #BAG005



Gear Duffel 30L

When anglers don't have a ton of stuff to tote around, Gamakatsu's water-resistant 30-liter Gear Duffel would be the best to pack up. The large main opening is secured with heavy-duty zippers for easy access, with an external zippered pocket that keeps oft-needed items at the ready. A separate, outer zippered access compartment for dirty clothes or gear keeps anglers clean stuff clean. An adjustable, padded removable shoulder strap lets anglers carry stuff hands-free, though the hook and loop fastener on the main carrying handles works as well.

Item #GB-DF-30





**GSPECX
PRECISION
OPTICS**

Qpalkakatsu®

GSPECX - GENKAI

Inspired by the fast-moving waters of Japan's Genkai region, this line of sunglasses is built for clarity, control, and all-day performance. Polarized lenses cut glare, enhance contrast, and provide full UV protection, while the lightweight wrap frame delivers a secure, comfortable fit that stays locked in through every cast. Designed for anglers who value precision and clean, modern style, Genkai brings focus to every moment on the water.

Available in regular and wide.



GSPECX™
GAMAKATSU® | PRECISION OPTICS



Genkai Green
GG310-R-GREEN
GG310-W-GREEN



Genkai Copper
GG310-R-COPPER
GG310-W-COPPER



Genkai Brown
GG310-R-BROWN
GG310-W-BROWN



Genkai Dark
Gray Mirror
GG310-R-DGRAY-M
GG310-W-DGRAY-M



Genkai Light
Gray Mirror
GG310-R-LGRAY-M
GG310-W-LGRAY-M



Genkai Yellow
Mirror
GG310-R-YELLOW-M
GG310-W-YELLOW-M

GSPECX - BIWA

Inspired by the depth and clarity of Japan's legendary Lake Biwa, this line of sunglasses is designed for steady vision in changing conditions. Premium polarized lenses filter glare while maintaining natural color and reducing eye fatigue, and the ergonomic wrap frame offers a secure, comfortable fit for long days outdoors. Built for anglers who rely on consistency and control, Biwa delivers dependable clarity from first light to last cast. *Available in regular and wide.*



Biwa Green
GG300-R-GREEN
GG300-W-GREEN



Biwa Copper
GG300-R-COPPER
GG300-W-COPPER



Biwa Brown
GG300-R-BROWN
GG300-W-BROWN



**Biwa Dark
Gray Mirror**
GG300-R-DGRAY-M
GG300-W-DGRAY-M



**Biwa Light
Gray Mirror**
GG300-R-LGRAY-M
GG300-W-LGRAY-M



**Biwa Yellow
Mirror**
GG300-R-YELLOW-M
GG300-W-YELLOW-M





**TOOLS AND
ACCESSORIES**

Galvakatsa[®]

Fishing Pliers 6"

Made of stainless steel to ward off corrosion and rust, Gamakatsu's heavy-duty pliers will become the tool you reach for whether you're an avid salt or freshwater angler. The Gamakatsu Stainless Steel Pliers have precise crimping jaws to fit various sizes of sleeves. The precision split ring feature on the needle nose tool makes changing or replacing split rings easy. The multi-tasking jaws on the pliers are able to cut braid, mono or fluorocarbon, and also feature a PTFE coating to aid against corrosion and rust. The handles feature a non-slip grip that helps you hold on during wet conditions. Included is a lanyard and sheath so the pliers are right where you need them. Item #P002



Fishing Pliers 7"

Made of stainless steel to ward off corrosion and rust, Gamakatsu's heavy-duty pliers will become the tool you reach for whether you're an avid salt or freshwater angler. The Gamakatsu Stainless Steel Pliers have precise crimping jaws to fit various sizes of sleeves. The precision split ring feature on the needle nose tool makes changing or replacing split rings easy. The multi-tasking jaws on the pliers utilize an outside cutter and are able to cut braid, mono or fluorocarbon, and also feature a PTFE coating to aid against corrosion and rust. The handles feature a non-slip grip that helps you hold on during wet conditions. Included is a lanyard and sheath so the pliers are right where you need them. Item #P003



Fishing Pliers 9" 45 Degree

Gamakatsu introduces the longest-length pliers to join the lineup, the 9-inch pliers. These pliers are similar to the popular 6 and 7-inch pliers, but Gamakatsu added a 45-degree angle to provide a comfortable position for various tasks. Say goodbye to awkward angles and hello to an ergonomic, reliable tool. The precision split ring feature on the needle nose tool makes changing or replacing split rings easy. The multi-tasking jaws on the pliers utilize an outside cutter and are able to cut braid, mono or fluorocarbon, and also feature a PTFE coating to aid against corrosion and rust. The handles feature a non-slip grip that helps you hold on during wet conditions. Included is a lanyard and sheath so the pliers are right where you need them. Item #P005



Micro Split Ring Plier

The 5-inch long pliers are made from stainless steel and feature a premium non-slip grip giving anglers a secure hold for fine operations like manipulating split rings. A spring in the handle holds the pliers open during use, and a corresponding lock keeps them closed for storage. Its precision micro-tip grips and opens super small split rings, and it is just as effective on large ones, too. A built-in braided line cutter cleanly shears tough fishing line. Item #P004



Ceramic Braid Scissors

The 4.75" Ceramic Braid Scissors are a great option for the serious or casual angler. These compact scissors feature ceramic serrated blades that cut braided and other fishing lines with ease. The ceramic blades incorporate a cutting-edge blade design to stay sharp longer, making them the perfect choice for all your line cutting needs. The ceramic blades are also rust proof for use in salt or freshwater.

Item #SC002

**Folding Braid Scissors w/ Split Ring Opener**

The Folding Braid Scissors with Split Ring Opener is a compact multi-function fishing scissor with similar construction elements as other Gamakatsu fishing tools. Its sharp stainless-steel blades will provide years of hard use snipping mono and cutting braided fishing line. The scissor's tips feature a handy split ring opener. The blades fold safely into the tool's blue handles for safe storage. When open, the 4-inch scissors proudly display the Gamakatsu name.

Item #SC001



Gamakatsu Microfiber Towel

Gamakatsu throws in the towel on fish slime, scales and other grime that can prevent you from getting a solid grip on your rod. Keep your hands clean and ready to fish with Gamakatsu's new Microfiber Towel. The absorbent microfiber construction of the Microfiber Towel efficiently cleans and dries hands in one pass, so that you can get back to fishing quickly. 12" x 12" Item #TW30



Gamakatsu Fingertip Protector

Protects your finger from the abuse of stripping line all day. One size.
Updated with new Kevlar reinforced finger protection.
 Item #GF003(1)





FLOATS

Spalkakatsu®

Premium Lighted Firetip Floats

Experience fishing like never before with Gamakatsu's Premium Lighted Firetip Floats. These floats redefine brightness with their unmatched luminosity, making them the brightest floats you'll ever see. Crafted with exceptional design and construction, they are built to last and withstand the demands of angling. With a visual range of over 100 yards, you'll never miss a strike, even in low-light conditions. The floats can easily be lit by simple unscrewing the top and inserting the battery. The soft, durable tip is built to withstand years of trouble free use. *(Soft tip not available on the Firetip Egg Float)*

The Gamakatsu Premium Lighted Firetip Floats feature a long battery life, ensuring extended usage for those all-night fishing adventures. Made from high impact plastic, these floats are built to endure the toughest fishing conditions. Available in a range of styles, including Regular Floats, Weighted Floats, and Egg Floats, each with various sizes, they cater to every angler's needs. Whether you're night fishing or prefer a battery-free experience during the day, the Gamakatsu Premium Lighted Firetip Floats offer unmatched versatility and reliability. Elevate your fishing game and maximize your success with these exceptional floats.

Firetip Float (BR435 Battery Included)

| Sizes | Small | Medium | Large |
|--------|---------|---------|---------|
| | GF005-S | GF005-M | GF005-L |
| Length | 4.25" | 4.75" | 5" |
| Weight | 0.23 oz | 0.25 oz | 0.30 oz |



Firetip Float Weighted (BR435 Battery Included)

| Sizes | Medium | Large | Extra Large |
|--------|---------|---------|-------------|
| | GF006-M | GF006-L | GF006-XL |
| Length | 5.5" | 6" | 6.75" |
| Weight | 0.55 oz | 0.64 oz | 0.83 oz |



Firetip Egg Float (Two BR425 Batteries Included)

| Sizes | Medium | Large |
|--------|---------|---------|
| | GF007-M | GF007-L |
| Length | 1.75" | 2" |
| Weight | 0.30 oz | 0.47 oz |



Medium



Large



KNIVES



Spalkatsa®

EDC Knife GMKT2

Gamakatsu introduces their new series of Every Day Carry (EDC) Knives. The most carry-friendly Gamakatsu knife is the GMKT2 EDC knife at 2.75-inches. This knife has a drop point blade, a two-toned satin finish, and a plain edge. The handle material is stainless steel with an attractive blue-wash finish. Features a tough, highly wear resistant D2 high-carbon tool steel constructed blade with excellent edge retention. The custom-designed GMKT2 utilizes an assisted opening action with flipper mechanism for fast and easy opening.

EDC Knife GMKT2 Features:

Custom designed Gamakatsu EDC knife featuring an assisted opening action with flipper mechanism.

Blade Style: Drop Point

Lock Type: Frame Lock

Blade Length: 2.75"

Blade Finish: 2 Tone Satin

Handle Finish: Bluewash

Blade Edge: Plain

Pocketclip: Fixed/Tip Up

Blade Material: D2

Handle Material: Stainless Steel

**EDC Knife GMKT1**

The GMKT1 EDC knife is 3.25-inches, sports a drop point blade with a plain edge, stonewash finish, and a black-wash stainless steel handle. The blade is constructed of D2 high-carbon tool steel that is very wear resistant and offers excellent edge retention. The custom designed GMKT1 is comfortable to hold and the black wash finish on the handle hides hard use scratches for years of everyday use. The assisted opening action with flipper mechanism allows for fast and easy opening every time.

EDC Knife GMKT1 Features:

Custom designed Gamakatsu EDC knife featuring an assisted opening action with flipper mechanism.

Blade Style: Drop Point

Lock Type: Frame Lock

Blade Length: 3.25"

Blade Finish: Stonewash

Handle Finish: Blackwash

Blade Edge: Plain

Pocketclip: Fixed/Tip Up

Blade Material: D2

Handle Material: Stainless Steel

**EDC Knife GMKT4**

The GMKT4 features a 3.5-inch Tanto style blade made from D2 high-carbon tool steel, with a black oxide finish and a plain edge. It features a G10/carbon fiber overlay and black oxide steel handle that's extremely strong but light in weight. The custom-designed GMKT4 features an assisted opening action with flipper mechanism so it's ready for action for any task.

3.5" EDC Knife GMKT4 Features:

Custom designed Gamakatsu EDC knife featuring an assisted opening action with flipper mechanism.

Blade Style: Tanto

Lock Type: Frame Lock

Blade Length: 3.5"

Blade Finish: Black Oxide

Handle Finish: Black CF/Black Oxide Steel

Blade Edge: Plain

Pocketclip: Fixed/Tip Up

Blade Material: D2

Handle Material: G10/Carbon Fiber Overlay



EDC Knife GMKT3

The largest EDC knife in the lineup is the GMKT3, it has a 3.625-inch stonewash finish blade that is partially serrated, combining the advantages of the plain edge with those of a serrated edge for the best of both worlds. It features a G10 front handle scale and stonewash black steel back handle. The custom-designed GMKT3 features an assisted opening action with flipper mechanism. The blade is constructed of D2 high-carbon tool steel that offers excellent edge retention and is very wear resistant.

EDC Knife GMKT3 Features:

Custom designed Gamakatsu EDC knife featuring an assisted opening action with flipper mechanism.

Blade Style: Drop Point

Blade Edge: Partially Serrated

Lock Type: Frame Lock

Pocketclip: Fixed/Tip Up

Blade Length: 3.625"

Blade Material: D2

Blade Finish: Stonewash

Handle Material: G10 Front Handle Scale/Steel Back Handle

Handle Finish: Black G10/Stonewash Steel



6" Fillet Knife GMKT6F

The 6" Gamakatsu fillet knife is the smallest size in the lineup and is designed for precise handling in smaller fish. The custom-designed fillet knife features the G-Grip handle for ultimate handling and non-slip performance. The blade features a DLC coating and provides anglers with premium performance, offering high wear resistance, reduced friction and enhanced hardness. The included blade protector keeps the edge protected when the knife is stored.

6" Fillet Knife GMKT6F Features:

Custom designed Gamakatsu fillet knife featuring G-Grip designed handle for a secure grip.

Blade Style: Trailing Point/Fillet

Blade Edge: Plain

Sheath: Blade Protector

Blade Length: 6"

Blade Material: 420J2 Stainless Steel

Blade Finish: DLC Coating (Diamond-Like Carbon)

Handle Material: Glass-filled nylon, rubber overmold.



7" Fillet Knife w/ Spoon GMKT7FS

The 7" Gamakatsu fillet knife with spoon is designed for fast work of bloodline removal, thanks to the integrated stainless-steel spoon. The custom-designed fillet knife features the G-Grip handle designed for ultimate handling and non-slip performance. The DLC coating on the blade provides anglers with premium performance, offering high wear resistance, reduced friction and enhanced hardness. The included blade protector keeps the edge protected when the knife is stored.

7" Fillet Knife w/ Spoon GMKT7FS Features:

Custom designed Gamakatsu fillet knife featuring G-Grip designed handle for a secure grip.

Blade Style: Trailing Point/Fillet

Blade Edge: Plain

Sheath: Blade Protector

Blade Length: 7"

Blade Material: 420J2 Stainless Steel

Blade Finish: DLC Coating (Diamond-Like Carbon)

Handle Material: Glass-filled nylon, rubber overmold.



7.5" Fillet Knife GMKT7.5F

The 7.5" Gamakatsu fillet knife is the middle size in the lineup and is designed to be more flexible, thanks to the thin profile blade. This is the perfect size for a large variety of fish. The custom-designed fillet knife features the G-Grip handle that is extremely comfortable during extended use and offers non-slip performance and handling. The Diamond-Like Carbon (DLC) coating on the blade provides anglers with premium performance, offering high wear resistance, reduced friction and enhanced hardness. The included blade protector keeps the edge protected when the knife is stored.

7.5" Fillet Knife GMKT7.5F Features:

Custom designed Gamakatsu fillet knife featuring G-Grip designed handle for a secure grip.

Blade Style: Trailing Point/Fillet

Blade Edge: Plain

Sheath: Blade Protector

Blade Length: 7.5"

Blade Material: 420J2 Stainless Steel

Blade Finish: DLC Coating (Diamond-Like Carbon)

Handle Material: Glass-filled nylon, rubber overmold.

**9" Fillet Knife GMKT9F**

The 9" Gamakatsu curved fillet knife is the largest blade in the lineup and is the perfect size for larger freshwater fish, saltwater fish and a wide variety of game. The custom-designed fillet knife features the G-Grip handle that is extremely comfortable during extended use and offers non-slip performance. The blade features a DLC finish and provides anglers with premium performance, offering high wear resistance, reduced friction and enhanced hardness. The included blade protector keeps the edge protected when the knife is stored.

9" Fillet Knife GMKT9F Features:

Custom designed Gamakatsu fillet knife featuring G-Grip designed handle for a secure grip.

Blade Style: Trailing Point/Fillet

Blade Edge: Plain

Sheath: Blade Protector

Blade Length: 9"

Blade Material: 420J2 Stainless Steel

Blade Finish: DLC Coating (Diamond-Like Carbon)

Handle Material: Glass-filled nylon, rubber overmold.

**Knife Roll Bag**

This knife bag comes with eight rubber mesh knife pockets to accommodate multiple sizes of knives. Many anglers now carry multiple knife sizes and specialty knives for efficient cleaning of a wide range of fish. The Knife Roll Bag allows you to securely and safely store many knives in a compact and easy to use system.

The Gamakatsu Knife Roll Bag is made from a PVC material that will shed water quickly, cutting down on the risk of water being trapped and rusting your knives during storage. The roll bag measures 16.5" x 5.5" x 1" when rolled up and closed.

Please note this Knife Roll Bag does not include any knives.

Item #GMKTRB1





APPAREL AND GEAR

Gamakatsu®



The Original Richardson 112 Trucker
Mid Pro Profile. Precurved Visor.
60/40 Cotton/Polyester
Heather Gray/Black
Item #G-H021



Gamakatsu Legacy Trucker
Washed canvas crown and mesh.
Unstructured, six-panel, low profile.
Precurved Visor, Snapback closure.
65/35 Cotton/Polyester
Black/Gray. Item #G-H024



Trucker Snapback Braid Hat
Trucker mesh. Pro-stitched finish.
Pro-model, Mid-profile. Curved Visor
Snapback adjustable. Cotton Blend.
White/Navy/Panther Teal.
Item #G-H022



Richardson 5 Panel Trucker
The iconic fit of the 112
Trucker with a 5-panel pinch
front construction.
Mid Pro Profile. Precurved Visor.
47/53 Cotton/Polyester
Bark Duck Camo/Brown
Item #G-H019



Gamakatsu Richardson Trucker Hat
Mid Pro Profile.
Precurved Visor.
60/40 Cotton/Polyester
Charcoal/White
Item #G-H026



Premium Cuff Beanie
Acrylic construction.
3 inch cuff.
8 inch fitted cuff.
Olive Green
Item #G-B003



Trucker Snapback Braid Hat
Trucker mesh. Pro-stitched finish.
Pro-model, Mid-profile. Curved Visor
Snapback adjustable. Cotton Blend.
Moss Green/Light Charcoal.
Item #G-H020



Trucker Hat Mesh Blk/Charcoal
60/40 cotton/polyester. Structured,
mid-profile, six panel. Pre-curved
contrast stitched visor. Adjustable
plastic snapback. Item #H015



Flat Bill Triple Black
100% cotton material.
Embroidered logo.
Adjustable Snap Back
Closure. Triple Black.
Item #H013



NEW

Gamakatsu Trucker Hat Mesh

Ccanvas crown and mesh. Unstructured, six-panel, low profile. Precurved Visor, Snap-back closure. 65/35 Cotton/Polyester Khaki/Brown. Item #G-H027



Gamakatsu Sunshield

Lightweight and versatile, the Gamakatsu Sun Shield features seamless, breathable, speed-dry microfiber for all-day protection from sun, wind, and dust. Item #SS002 Blue Camo | Item #SS003 Gray Camo



NEW



Gamakatsu Pro Staff T-Shirt Gray

4.2 oz. 100% Airlume combed and ring-spun cotton. Pre-shrunk. Retail fit. Unisex sizing Tear away label. Athletic Heather
 Sizes S-XXXL • Item #G-T019



Gamakatsu Pro Staff T-Shirt Navy

4.2 oz. 100% Airlume combed and ring-spun cotton. Pre-shrunk. Retail fit. Unisex sizing Tear away label. Navy
 Sizes S-XXXL • Item #G-T018



Back

Front

Gamakatsu Tuna T-Shirt

4.2 oz. 100% Airlume combed and ring-spun cotton. Pre-shrunk. Retail fit. Unisex sizing Tear away label. Columbia Blue
 Sizes S-XXXL • Item #G-T017



Back

Front

Gamakatsu Bass T-Shirt

4.2 oz. 100% Airlume combed and ring-spun cotton. Pre-shrunk. Retail fit. Unisex sizing Tear away label. Military Green
 Sizes S-XXXL • Item #G-T016



Gamakatsu Trout T-Shirt

4.2 oz. 100% Airlume combed and ring-spun cotton. Pre-shrunk. Retail fit. Unisex sizing Tear away label. Athletic Gray
 Sizes S-XXXL • Item #G-T015



Back

Front

Gamakatsu G-Logo T-Shirt

4.2 oz. 100% Airlume combed and ring-spun cotton. Pre-shrunk. Retail fit. Unisex sizing Tear away label. White
 Sizes S-XXXL • Item #G-T014



Gamakatsu Simms Solarflex Hoodie

8 oz. 92/8 Polyester/Spandex.
UPF 50+ rated sun protection
Regiment Camo Neptune
Sizes S-XXL Item #G-PF006



Gamakatsu Logo Heavyweight Hoodie

10 oz. 80% Cotton/20% Poly Blend
The 3-end fleece fabric has a tight knit construction giving it a lofty handfeel
Storm Gray. Sizes S-2XL. Item #G-S010



Gamakatsu Marsh Wear Pamlico Performance Hoodie

UPF 40+ rated sun protection. Stain release.
Moisture wicking fabric. 65/35 Polyester/Rayon.
Green Mallard Camo. Sizes M-2XL.
Item #G-PF002



Gamakatsu Simms SolarFlex® Crewneck

UPF 50+ rated sun protection. Back-of-hand coverage. Simms' top solar protective knit fabric. Fast drying, odor-free tech. Extended sleeve w/ thumbholes, finger loop. Single panel under sleeves and side body for increased movement. Merrow and flat-seam construction for maximum comfort.
92/8 Polyester/Spandex . Sterling Sizes S-2XL.
Item #G-PF003



Front

Back >>



Navy



Brown



Sand

Gamakatsu Retro Sweatshirt

50/50 cotton/polyester, 2-end midweight fleece fabric, Air jet yarn for softer feel and reduced pilling, Double-needle stitching at shoulders, armholes, neck, waistband and cuff. 1x1 rib with spandex for enhanced stretch and recovery Sizes S-3XL. Item #S006, Navy • Item #S007, Brown • Item #S008, Sand



NEW

LUXXE T-Shirt

Clean, classic, and built for everyday comfort, the LUXXE T-Shirt delivers a premium look that reflects the heritage of advanced rod design. Featuring the bold LUXXE logo across the chest with subtle sleeve detailing, this tee combines soft, breathable fabric with a modern fit that wears easy on and off the water. Whether you're on the boat or off the clock, it's a straightforward staple for anglers who appreciate performance-driven style.

White. Sizes S-3L.

Item #53518



NEW

LUXXE Long Sleeve T-Shirt

Built for comfort with a bold, performance-driven look, the LUXXE Long Sleeve T-Shirt delivers everyday wearability on and off the water. Featuring the signature LUXXE logo across the chest and down the sleeves, this shirt combines soft, breathable fabric with added coverage for changing conditions. Designed with a modern fit and durable construction, it's a versatile staple for anglers who want clean style with all-day comfort.

Black. Sizes S-3L.

Item #53519



G-Finesse Decal

Yellow #21
White # 20
Solid #19



Tuna Boat Decal

9 inch - white #14
9 inch - red #18
9 inch -blue #15



Embroidered Patch

4 1/2 inch
#124



Small Boat Decal

7 inch
White #7
Blue #7-B
Lime Green #7-LG



Large Boat Decal

18 inch
Blue #1
White #2

Gamakatsu Carpet Sticker

18 Inch. Item #24





Can-Am Sales Group

6615 Grand Avenue, #295, Gurnee, IL 60031

866-220-1845

GAMAKATSU • 253-922-8373

British Columbia, Alberta, Saskatchewan, Manitoba

SPRO • 770-919-1722

Ontario, Quebec, New Brunswick, Nova Scotia, Newfoundland and Labrador



GAMAKATSU USA

P.O. Box 1797 Tacoma, WA 98401
253-922-8373 • Fax 800-223-9383

SPRO Corporation

3750 Kennesaw 75 Pkwy, Suite 100
Kennesaw, GA 30144
770-919-1722 • FAX 770-919-8141

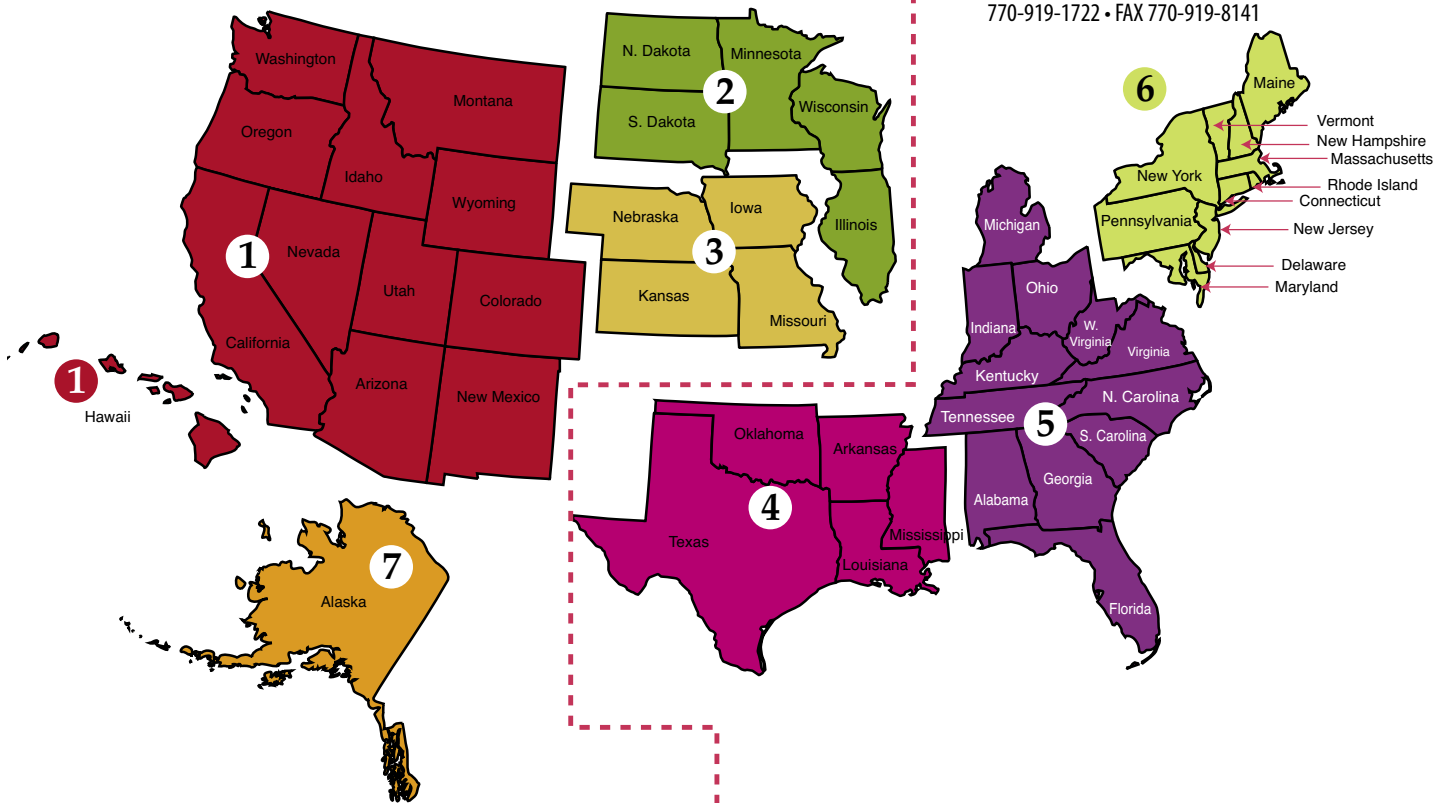

Regions 1, 2, 3, 7

Gamakatsu USA ... 253-922- 8373
or the following representatives:

REGION 1: L.H. French Company

1071 West 251st Street • Harbor City, CA 90710
310-326-6543 (Corporate Office)

17019 NE 136 Place • Redmond, WA 98052
425-869-7909 (Northwest Office)

TERRITORY: Washington, Oregon, Idaho, Montana, Wyoming, California,
Nevada, Utah, Colorado, Arizona, New Mexico, Hawaii

REGION 2: Outdoor Brand Team

645 Hwy T-14, Pella, IA 50219
641-780-2510

TERRITORY: Wisconsin, Minnesota, N. Dakota, S. Dakota, Illinois

REGION 3: Alexander and Townsend, Inc.

503 N. Mur-Len Road, Suite A • Olathe, KS 66062
913-829-3266

TERRITORY: Missouri, Iowa, Nebraska, Kansas

REGION 7: Skyline Sales & Service

20734 Crabtree St. • Chugiak, AK 99567
907-688-9993
TERRITORY: Alaska

Regions 4, 5, 6

SPRO Corporation ... 770-919-1722
or the following representatives:

REGION 4: Frontier Marketing

6227 Paddle Wheel • Katy, TX 77449
281-433-2495

TERRITORY: Arkansas, Louisiana, Mississippi, Oklahoma, Texas

REGION 5 : Outdoor Brand Team

645 Hwy T-14, Pella, IA 50219
641-780-2510

TERRITORY: Alabama, Florida, Georgia, Indiana, Kentucky, Michigan, North Carolina, Ohio,
South Carolina, Tennessee, Virginia and West Virginia

REGION 6: Sheridan - Nisito Marketing

9 Academy Road • Hatboro, PA 19040
215-674-5222

TERRITORY: Delaware, Maryland, Maine, Vermont, New Hampshire, Massachusetts, New York,
New Jersey, Connecticut, Pennsylvania, and Rhode Island



Gamakatsu

WWW.GAMAKATSU.COM